

# XRS8 SPECIFICATIONS

XRS8 two way 8 inch woofer and 1 inch compression driver low impedance speaker system supplied with U bracket and foldback kit.

## POLAR PLOTS – Vertical directivity

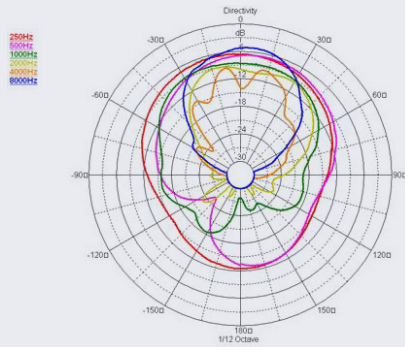

CURVE	FREQ	0dB	-6dB angle	Q	DI
—	250Hz	-6.6	165.6	2.4	3.8
—	500Hz	-6.9	148.4	2.8	4.5
—	1000Hz	-8.6	136.4	2.9	4.6
—	2000Hz	-9.9	103.5	3.7	5.7
—	4000Hz	-13.9	100.4	2.7	4.3
—	8000Hz	-5.3	71.2	6.5	8.1

## POLAR PLOTS – Horizontal directivity

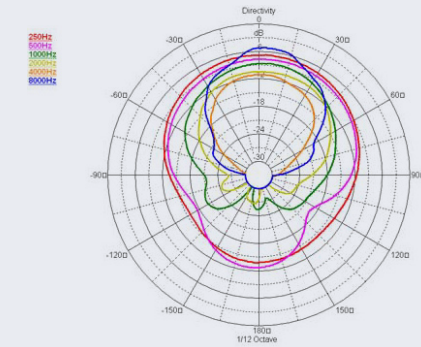

CURVE	FREQ	0dB	-6dB angle	Q	DI
—	250Hz	-6.8	187.6	2.3	3.6
—	500Hz	-7.7	180.0	2.3	3.6
—	1000Hz	-8.7	128.0	3.6	5.6
—	2000Hz	-10.4	120.4	3.6	5.6
—	4000Hz	-11.1	89.8	5.2	7.1
—	8000Hz	-5.3	72.4	7.0	8.5

## FREQUENCY RESPONSE CURVE

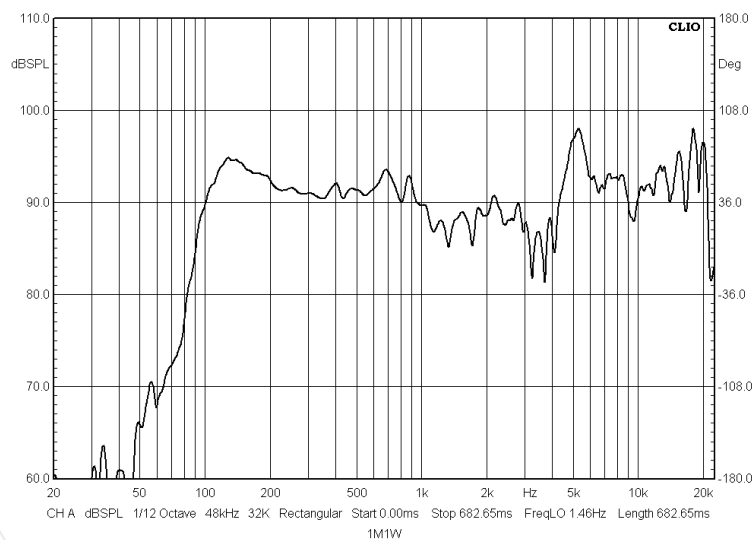



## XRS8 SPECIFICATIONS

### DIMENSIONS (mm)

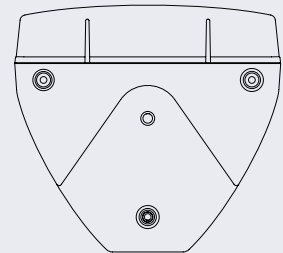
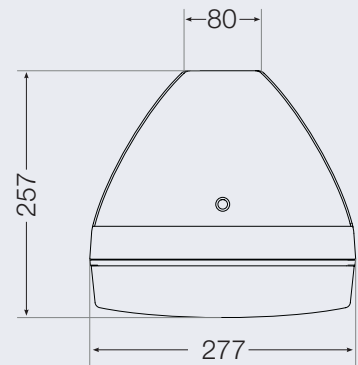
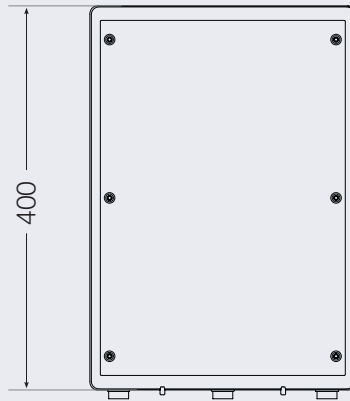
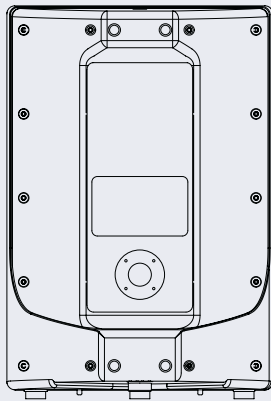

SPECIFICATIONS	XRS8
POWER	100W RMS
FREQUENCY RESPONSE	65Hz - 18kHz
SENSITIVITY	92dB (1W / 1Metre)
COMPRESSION DRIVER DISPERSION	90 x 90
WEIGHT	6.5kg