

VOLANTE

— Magnetic Echo Machine —

USER MANUAL

strymon®

Table of Contents

.....

FRONT PANEL	3
REAR PANEL	9
FOOTSWITCHES	13
SOUND ON SOUND	15
LIVE EDIT FUNCTIONS	18
EXPRESSION PEDAL	20
POWER UP MODES	22
MULTISWITCH PLUS	26
FACTORY RESET	28
MIDI IMPLEMENTATION	29
OUTPUT MODES	33
SIGNAL FLOW DIAGRAM	36
FEATURES AND SPECIFICATIONS	37
FACTORY PRESET SETTINGS	39
WARRANTY	41

Front Panel - Tonality

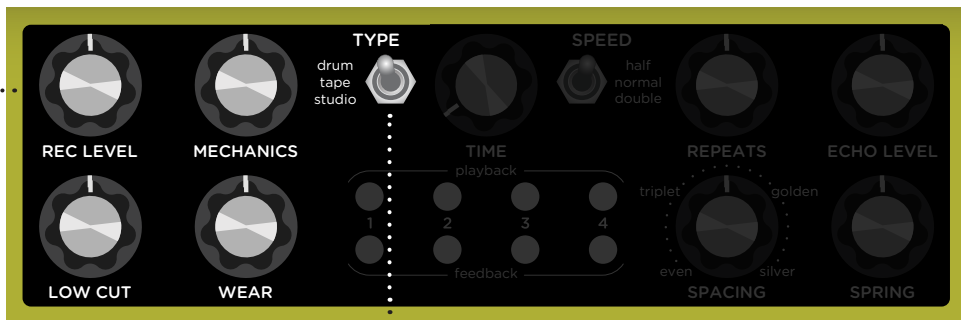

REC LEVEL

Controls the analog preamp gain of the signal fed into the processor. When turned up, fat and saturated signals are sent to the record head. Turn down for cleaner delay signals.

Class A Analog JFET Input Buffer-Touch response and dynamic interaction with your guitar are optimized with a discrete class A JFET buffer.

TYPE

Selects between three available magnetic media types.

drum: Steel wire spinning platter. Atmospheric echoes emphasize the low-mid frequencies and will saturate with hot signals or high feedback.

tape: Magnetic tape used in vintage echo machines. Warm tape response with moderately clean and airy signal path.

studio: Clean studio-grade tape used in reel-to-reel units.

Front Panel - Tonality (cont.)

MECHANICS

Controls the amount of mechanically related speed fluctuations and media irregularities, including: friction, creases, splices, and contaminants.

Set to minimum for a fresh, clean recording medium.
Set to maximum for a recording medium that is in need of service.



LOW CUT

Controls the low frequency shaping of the echo repeats. Set to minimum for extended low frequency bandwidth. Set to maximum for extremely high-passed repeats.

WEAR

Controls the wear of the media and heads which affects the fidelity of the high frequencies. Set to minimum for a fresh, full bandwidth sound.

Front Panel - Head Configuration

feedback

Enables or disables feedback of the corresponding **playback** head signal to the record head.

PANNING

Turn the **TIME** knob while pressing and holding the individual **feedback** buttons to adjust the panning for each playback head. Adjusting the knob to twelve o'clock returns the head to the center position (the corresponding **playback** button will light up **RED**.)

playback

Selects which of the individual playback heads are engaged (**GREEN** LED ON).

HEAD VOLUME

Press and hold for one second to toggle between half and full volume.

GREEN LED ON = full volume.

AMBER LED ON = half volume.

REPEATS

Controls the feedback amount for the heads that have their feedback enabled.



NOTE: A head can be fed back to the input even if its **playback** is disengaged.

NOTE: When all heads are panned to center, a psychoacoustic stereo process is applied to the delay signal.

Front Panel - Head Configuration (cont.)

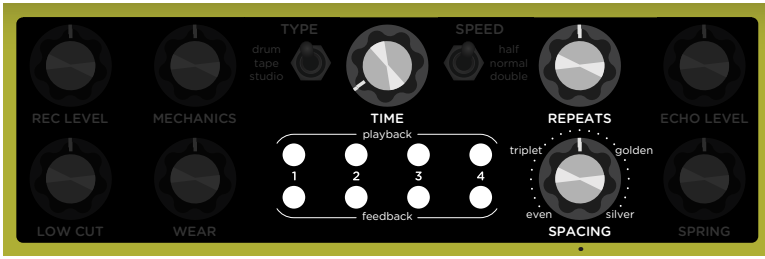



SPACING

Adjusts the spacing between the heads. Turning the knob morphs the heads in between the marked settings.

SPACING CONFIGURATIONS

 ... **even:** Sets the heads evenly to produce delays of sixteenth note, eighth note, dotted eighth, and quarter note.

 ... **triplet:** Sets heads to sixteenth note triplet, eighth note triplet, quarter note triplet and quarter note.

golden: Sets the distances between each of the heads according to the golden ratio, resulting in the fastest density buildup when multiple heads are repeating.

silver: Sets the distances between heads according to the silver ratio, resulting in repeats that “bunch up” closer to the head 4 quarter note.

Front Panel - Time

TIME

Controls the delay time at head 4. Heads 1-3 subdivide proportionately according to the **SPACING** setting. Turn the knob to the left for shorter delays and to the right for longer delays. Delay time ranges vary by selected speed setting.

NOTE: The delay time is determined by a combination of two factors: the distance between the record and playback heads and the speed of the media. The distance is determined by the **TIME** knob. The **SPEED** switch selects the speed of the media.

Delay Ranges at head 4

- half 400ms - 4 sec
- normal 200ms - 2sec
- double 100ms - 1sec

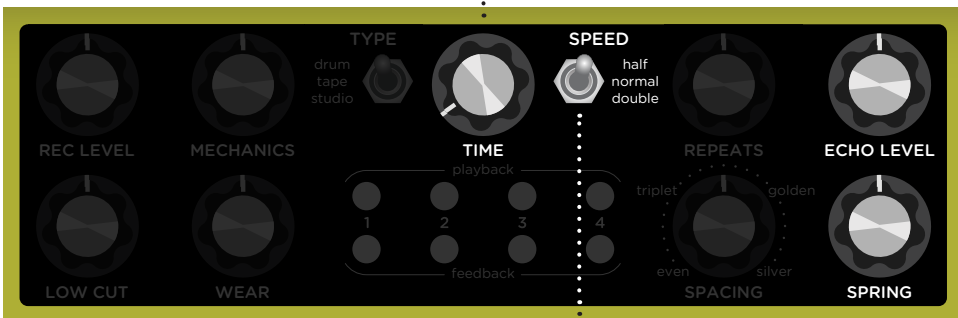

SPEED

Selects the speed of the media.

Front Panel - Mix

ECHO LEVEL

Sets the overall delay signal level sent to the output.



NOTE: The shortest possible delay time is achieved by setting **SPACING** to **triplet** and selecting head **1**.

SPRING

Controls the output mix of the integrated spring reverb tank. The dry signal input and **ECHO LEVEL** knob control the signals feeding into the spring reverb effect. The reverb effect is located just before the output. To bypass, turn the knob all the way to the left.

Rear Panel

INPUTS

High impedance audio inputs. Use **LEFT IN** for mono input. Connect a jack to the **RIGHT IN** for stereo input.

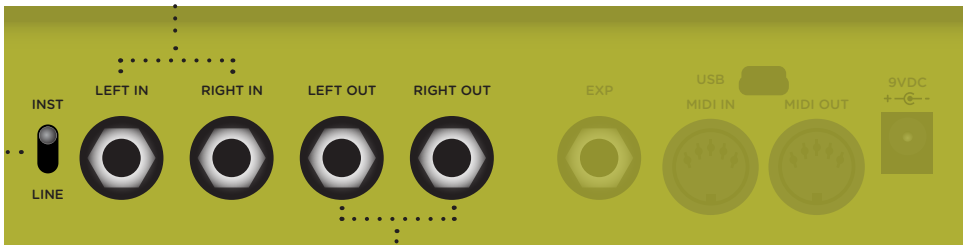

OUTPUTS

Audio signal outputs. Use **LEFT OUT** for mono output.

(See [page 33](#) for details.)

INST/LINE Switch

Sets the input level to the effect processing. Setting to LINE adds 10dB of clean headroom.

- Use INST for guitars or instruments with lower output.
- Use LINE for synthesizers, or when placing Volante in the effects loop of an amplifier or mixer, or for guitar rigs with high output levels if more clean headroom is desired.

Rear Panel (cont.)

MIDI IN

Full featured 5-pin DIN MIDI input. Provides support for receiving:

- MIDI Program Change (PC) messages to recall up to 300 presets.
- MIDI Continuous Controller (CC) messages to control the individual parameters of Volante including all knobs, switches, buttons, and Live Edit functions.
- MIDI Clock to sync the delay time with an external MIDI Clock source.

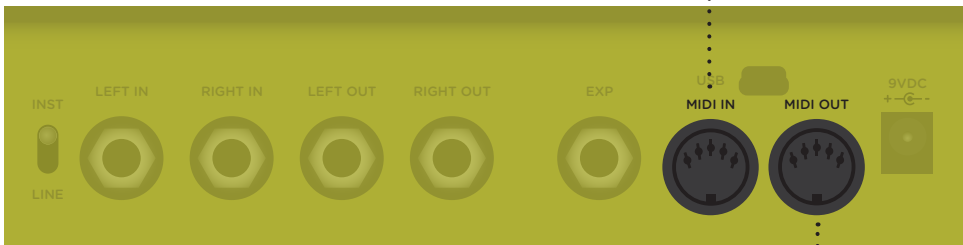

MIDI OUT

Can be set to send MIDI messages received at the **MIDI IN** port or send MIDI data generated by Volante.

(See [page 24](#) for details.)

NOTE: Volante can respond to MIDI Clock along with MIDI PC and MIDI CC messages received at the **MIDI IN** or **USB** on the assigned MIDI Channel.

(See [page 24](#) for details.)

Rear Panel (cont.)

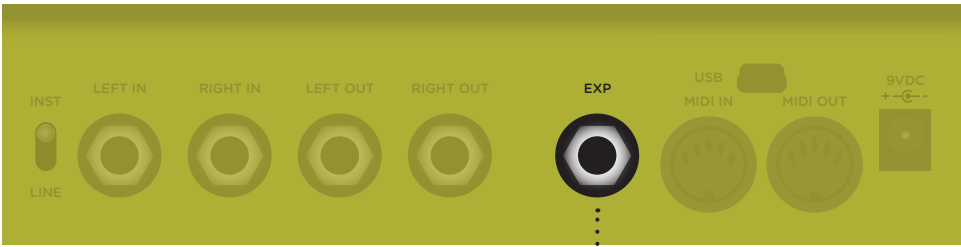

EXP



ECHO LEVEL

To configure the **EXP** jack, press and hold the **TAP** button while powering up Volante.

Turn the **ECHO LEVEL** knob to select the mode. The current mode will be displayed on the **TAP** LED.

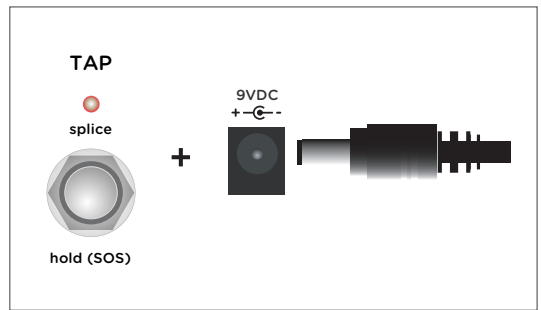

Expression Pedal Mode = GREEN: Allows continuous control over any of the knobs in any direction with a standard TRS expression pedal.

(See page 20 for details.)

External TAP Mode = AMBER: Allows you to use an external MiniSwitch to control the TAP tempo.

Preset Mode = BLUE: Allows for the selection of up to three presets using a Strymon MultiSwitch Plus or 300 Presets by sending MIDI Program Change messages via 1/4" TRS MIDI connection.

Speed Mode = PURPLE: Toggle between the three settings of the **SPEED** switch using a Strymon MultiSwitch Plus.

Transport Mode = RED: Provides access to additional transport controls using a Strymon MultiSwitch Plus.

SOS Looper Mode = WHITE: Provides instant access to the SOS Looper controls using a MultiSwitch Plus.

(See page 26 for details.)

Rear Panel (cont.)

USB

Used for connecting to a computer to control via MIDI.

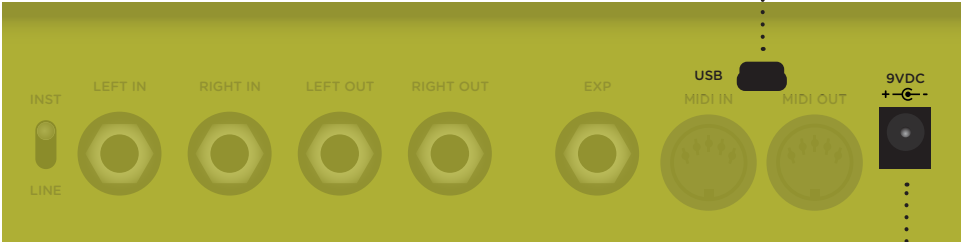

POWER

Use an adapter with the following rating: 9VDC center negative. 300mA minimum.

Footswitches

ON

Activates audio processing. Press to engage (**GREEN** LED ON) or bypass (LED OFF) the effect. Press and hold to activate infinite repeats with oscillation (**AMBER** LED ON).

BYPASS is configured for True Bypass (using electromechanical relays) by default, but can also be set to Buffered Bypass.

(See [page 24](#) for details.)



TAP

Sets quarter note delay time for Playback Head 4. The **TAP** LED will flash to indicate the delay time in quarter notes. **TAP** ranges are as follows:

- half** - 100ms to 4sec
- normal** - 100ms to 2sec
- double** - 100ms to 2sec

Footswitches (cont.)

FAVORITE

RECALL ACTIVE FAVORITE

Press the **FAVORITE** footswitch once to engage the active onboard preset.

CHOOSE ACTIVE FAVORITE

While holding down the **FAVORITE** footswitch, the **playback/feedback** buttons represent preset locations. Press one of these buttons to select the active favorite.

SAVE TO A PRESET LOCATION

Press and hold the **FAVORITE** footswitch until the LED flashes **BLUE** to enter SAVE mode, then release the footswitch.

There are three ways to select a preset location and complete the save:

- Press the **FAVORITE** footswitch to save to the currently selected preset location.
- Press one of the eight **playback/feedback** buttons to save to the corresponding preset location.
- Send Volante a MIDI Program Change message to save to the corresponding preset location.

Saving a favorite saves all knob, switch, and button settings, as well as all Live Edit functions and expression control settings.

To exit without saving, press the **TAP** footswitch.

COMPARE MODE

As knob and switch settings are adjusted with the **FAVORITE** engaged, the LED temporarily changes from **GREEN** to **RED** when the current position is identical to the saved favorite.

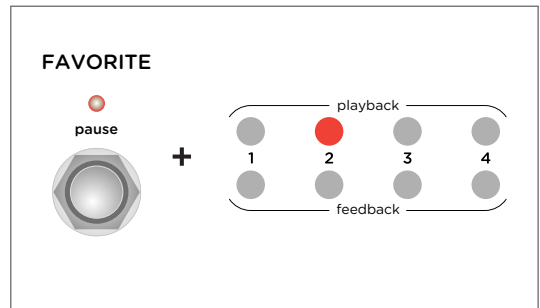

NOTE: The eight presets associated with the **playback** and **feedback** buttons are assigned to MIDI Program Changes 0-7.

Sound on Sound (SOS)

Press and hold **TAP** to enter and exit SOS mode. The **ON** LED will illuminate **AMBER** when in SOS mode. The functionality of all the footswitches changes when in SOS mode, as described below.

ON

Press **ON (reverse)** momentarily to reverse the playback of the Sound on Sound looper. (**RED ON LED**)

Press and hold to enter Infinite mode which disables the record head and continuously plays the most recent loop length audio without degrading. (Blinking **ON LED**)

SPEED

SOS mode max recording time:

half - 64 sec

normal - 32 sec

double - 16 sec



Sound on Sound (SOS) (cont.)



FAVORITE

Press **FAVORITE (pause)** momentarily to Stop/Resume playback of the recorded loop.

Press and hold **pause** to stop playback of the tape with mechanical slowdown effect. Release **pause** to resume playback with mechanical startup effect.

(**AMBER ON LED**)

TAP

Press **TAP (splice)** once to set the splice in point of the loop. (**TAP LED** blinks **AMBER**)

Press **splice** again to splice out and start loop playback from splice in point. (**TAP LED** solid **AMBER**)

Press **splice** once more to clear the recorded loop. (**TAP LED** off)

NOTE: Volante can adjust the **Pause Ramp Speed**, **SOS Repeat Level**, and the **SOS Loop Level** independently.

(See [page 18](#) for details.)

NOTE: With Volante's EXP jack set to **SOS Loper Mode**, you can have instant access to the looper controls with **MultiSwitch Plus**. (See [page 16](#) for details.)

Sound on Sound (SOS) (cont.)

How to record a loop.

- 1 Press and hold **TAP** to enter SOS mode.
- 2 Press **TAP (splice)** once to start recording. (**TAP LED** will flash **AMBER**)
- 3 Press **splice** again to close loop and start playback. (**TAP LED** solid **AMBER**)
- 4 Press **splice** again to stop loop playback and delete loop.

ADDITIONAL SOUND ON SOUND TIPS:

INFINITE HOLD

Press and hold the **ON (∞)** footswitch for one second to enter Infinite mode to disable the record head and prevent the recorded loop from degrading. (Blinking **ON LED**)

REVERSE

To play the recorded loop in reverse, momentarily press the **ON (reverse)** footswitch to engage the **reverse** function and play the recorded loop backwards. (**ON LED RED**)

PAUSE

To pause the recorded loop without deleting, press **FAVORITE (pause)**. (**AMBER FAVORITE LED**)

Press and hold **pause** to stop playback of the loop with mechanical slowdown effect. Release pause to resume playback with mechanical startup effect. Pause ramp speed can be adjusted.

(See [page 18](#) for details.)

Live Edit Functions

Volante provides a way to adjust several settings that do not have a dedicated knob or switch. In order to access these functions, press and hold **FEEDBACK** buttons 1 and 4 together while turning the assigned knobs.

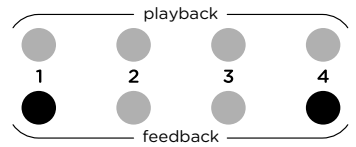

MIDI CLOCK

Turn **REC LEVEL** knob to have Volante sync with MIDI clock. **ON** LED indicates selection.

Off = **RED** (default)

On = **GREEN**

SOS REPEAT LEVEL

Turn **REPEATS** knob to adjust. Turning the knob to the left decreases the number of SOS loop repeats.



PAUSE RAMP SPEED

Turn **MECHANICS** knob to adjust. Turning the knob to the left makes the pause ramp more slowly. Turning the knob to the right makes the pause ramp more quickly.

SOS LOOP LEVEL

Turn **ECHO LEVEL** knob to adjust. Turning the knob to the left turns down the SOS loop volume.

Live Edit Functions (cont.)

RESPOND / IGNORE MIDI EXPRESSION

Turn the **LOW CUT** knob to select whether Volante will respond to MIDI Expression CC #100. **ON** LED indicates selection.

Off = **RED** (default)

On = **GREEN**



SPRING DECAY

Turn **SPRING** knob to adjust. Turning the knob to the left shortens the spring reverb decay. Turning to the right provides a longer reverb decay.

NOTE: Each of these parameters are saved independently in each preset.

Expression Pedal Setup

Use a TRS Expression pedal to control the knobs of Volante.

- 1 Configure the **EXP** jack for Expression mode.
(See [page 11](#) for details.)
- 2 Connect the Expression pedal to the **EXP** jack of Volante using a TRS cable.

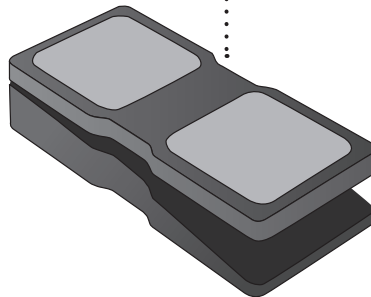
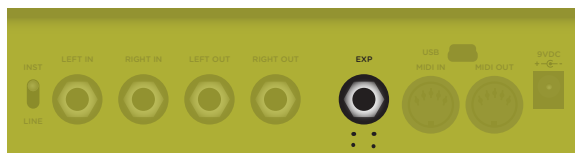

- 3 Press and hold **feedback 2** and **3** buttons for one second until all the buttons are flashing **GREEN**.

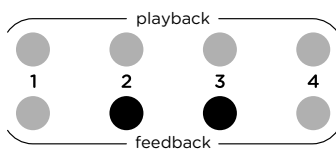

- 4 Rock the expression pedal back to the HEEL position and all the **feedback** buttons will flash **GREEN**.

Expression Pedal Setup (cont.)

- 5 Set the knobs the way you would like them to be in the HEEL position. The **feedback** buttons will now flash **RED**.
- 6 Rock the expression pedal forward to the TOE position and all the **playback** buttons will flash **GREEN**.
- 7 Set the knobs the way you would like them to be in the TOE position. The **playback** buttons will now flash **RED**.
- 8 Press any **feedback** button to store and exit setup. Buttons will stop flashing.

NOTE: Expression pedal settings are saved and recalled as part of the on-board favorite setting and MIDI accessible presets.

Power Up Modes

Global parameters and functions can be accessed via a power up procedure. All power up functions persist through power cycles.

- Start with the pedal unplugged. Press and hold the **TAP** footswitch and then power the pedal by connecting the 9V power cable.
- Adjust the desired functions with the knobs and buttons noted below.
- Press the **TAP** footswitch to exit power up mode.

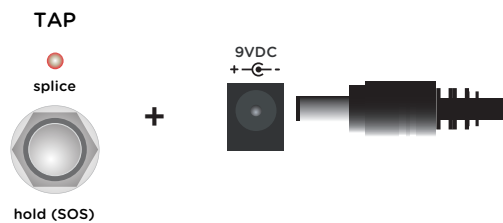

SET MIDI CHANNEL

Turn the **REC LEVEL** knob to select. **ON** LED indicates channel selection.

1 = **GREEN** (default)

2 = **AMBER**

3 = **RED**

4-16 = **BLUE** (channel set by next MIDI message) With this option, MIDI Channel is set to the channel of the next incoming MIDI Program Change message received.

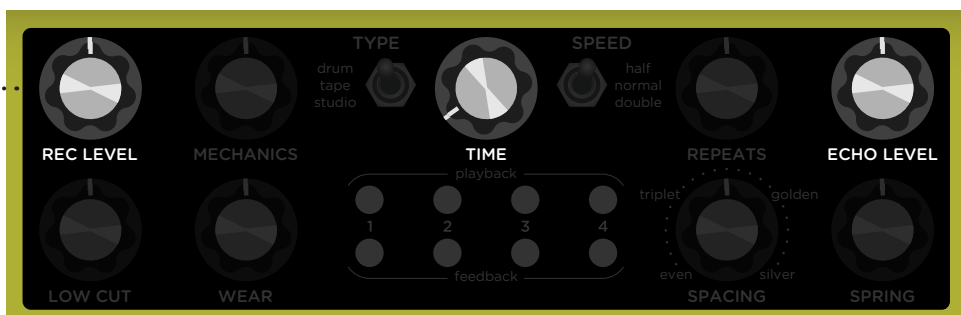

Power Up Modes (cont.)

TRS MIDI OUTPUT

Turn the **TIME** knob to select mode. **FAVORITE** LED indicates selection.

On = GREEN: Using Volante's knobs and switches generates MIDI messages that are sent out of Volante.

Through = AMBER: Incoming MIDI messages are sent out of Volante without additional MIDI messages generated by Volante.

Off = RED: No MIDI messages are sent out of Volante.



EXP JACK OPTIONS

Turn **ECHO LEVEL** knob, status shown on **TAP** LED.

Expression Pedal Mode = **GREEN**

External TAP Mode = **AMBER**

Preset Mode = **BLUE**

Speed Mode = **PURPLE**

Transport Mode = **RED**

(See [page 11](#) for details.)

Power Up Modes (cont.)

- Start with the pedal unplugged. Press and hold the **TAP** footswitch and then power the pedal by connecting the 9V power cable.
- Adjust the desired functions with the knobs and buttons noted below.
- Press the **TAP** footswitch to exit power up mode.

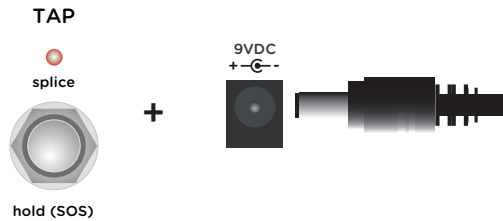

MIDI PROGRAM CHANGE

Press the **PLAYBACK 2** button.

Send MIDI Program Change **On** = **GREEN**

Send MIDI Program Change **Off** = **RED** (default)

SEND MIDI CC

Press the **PLAYBACK 1** button.

Send MIDI CC **On** = **GREEN**

Send MIDI CC **Off** = **RED** (default)

DIN MIDI THROUGH

Press the **PLAYBACK 3** button.

On = **GREEN** (default) **NOTE:** Only messages generated by Volante's UI are sent out of Volante **MIDI OUT** port.

Through = **RED** **NOTE:** MIDI messages sent to Volante are echoed to the **MIDI OUT** port without adding messages generated by the UI.

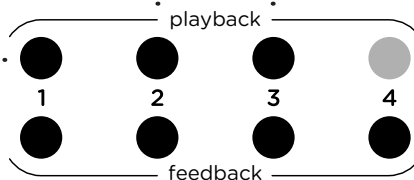

Power Up Modes (cont.)

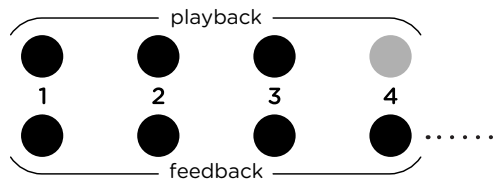

BYPASS MODE

Press the **FEEDBACK 1** button.

True Bypass = **GREEN**
(default)

Buffered Bypass = **RED**

SPILLOVER

Press the **FEEDBACK 2** button.
Enabling Spillover automatically puts Volante into Buffered Bypass mode.

Persist On = **GREEN**

Persist Off = **RED** (default)

KILL DRY

Press the **FEEDBACK 4** button.

Kill Dry On = **GREEN** (dry signal is not present)

Kill Dry Off = **RED** (dry signal is present) (default)

OUTPUT SUM ON/OFF

Press the **FEEDBACK 3** button.

Sum the output signal to mono. Use **LEFT OUT** for summed mono signal.

Off - **STEREO** = **GREEN**
(default)

On - **MONO SUM** = **RED**

(See page 33, 34, 35 for details.)

MultiSwitch Plus

- 1 Configure the **EXP** jack for MultiSwitch Plus mode.
(See [page 11](#) for details.)
- 2 Connect the MultiSwitch Plus
to the **EXP** jack of Volante
using a TRS cable.

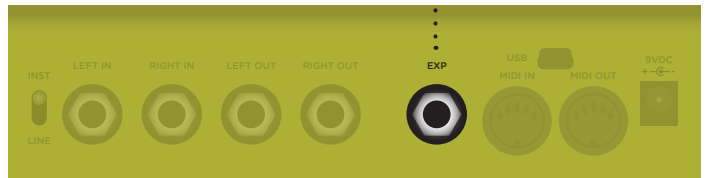

NOTE: The Speed and Transport mode controls work in both SOS and Normal operation.

NOTE: When in Transport Mode, engaging the infinite function on MultiSwitch Plus while Volante is in Normal operation will provide circular repeats where audio in the delay line will infinitely repeat maintaining a static volume without oscillation or degradation.

MultiSwitch Plus (cont.)

- 3 Press and hold the **A** footswitch on MultiSwitch Plus when connecting the TRS cable to MultiSwitch Plus for Preset mode.



Preset Mode (onboard presets)	Preset 1 (playback 2)	Preset 2 (playback 3)	Preset 3 (playback 4)
OR	⋮	⋮	⋮
Press and hold the C footswitch on MultiSwitch Plus when connecting the TRS cable to MultiSwitch Plus for Speed mode or Transport mode.	⋮	⋮	⋮
Speed Mode	half	normal	double
Transport Mode	reverse	pause	infinite
SOS Looper Mode	infinite	pause w/ mechanics	splice

- 4 MultiSwitch Plus will now function according to the EXP jack mode you have chosen in step one.

NOTE: When in SOS Looper Mode, pressing and holding the C footswitch on MultiSwitch Plus will exit the SOS Looper, returning Volante back to normal operation. The *infinite* and *pause w/ mechanics* functions on MultiSwitch Plus will also work while in normal operation.

Factory Reset

Restore the pedal to factory default settings.

- 1 Press and hold the **ON** footswitch during power up. **ON** LED will blink **RED**.
- 2 Release the footswitch and turn the **TIME** knob from 0-100% and back two (2) times. The **FAVORITE** LED will change from **AMBER** to **RED** at the extremes of the knob range. All the footswitch LEDs will blink **RED** to indicate that the reset is taking place.



FACTORY DEFAULT SETTINGS

- EXP Input Jack: Expression Mode
- Bypass Mode: True Bypass
- MIDI channel: 1
- MIDI Expression On/Off: Off
- TRS MIDI Output Mode: Off
- Send MIDI Program Change: Off
- Send MIDI CC: Off
- DIN MIDI THROUGH: On
- Kill Dry: Off
- Output Sum On/Off: Off – Stereo
- Persist: Off

MIDI - Specifications

MIDI PATCH CHANGES

Volante contains 300 preset locations, numbered sequentially from 0-299. Because MIDI Program Change messages have a maximum number of 128 (0-127) the presets are grouped into three MIDI patch banks.

- MIDI BANK 0 = PRESETS 0-127
- MIDI BANK 1 = PRESETS 128-255
- MIDI BANK 2 = PRESETS 256-299

Volante always powers up in MIDI Patch Bank 0, so if you plan to stay within the first 127 presets, simply send a standard MIDI Program Change message to load a preset.

If you will be using MIDI Banks 1 and/or 2, it is advisable to send a standard MIDI Bank Change message (MIDI CC# 0 with a value equal to the MIDI Bank#) before each MIDI Program Change.

Selecting bank 0, patch 127 will put Volante into Manual mode. In this mode, the pedal will be set to the current knob and switch settings. No preset data can be stored at this preset location.

MIDI - Specifications (cont.)

MIDI CC NUMBERS

PARAMETERS	CC#	RANGE	NOTES
Bank Select	0	0-2	
Type	11	1-3	(1=studio, 2=drum, 3=tape)
Echo Level	12	0-127	
Rec Level	13	0-127	
Mechanics	14	0-127	
Wear	15	0-127	
Low Cut	16	0-127	
Time	17	0-127	
Spacing	18	0-127	(even=0, triplet=34, golden=94, silver)
Speed	19	1-3	(1=double, 2=half, 3=normal)
Repeats	20	0-127	(0=off, 1-127=on)
Head 1 Playback Off/On	21	0, 127	(0=off, 1-127=on)
Head 2 Playback Off/On	22	0, 127	(0=off, 1-127=on)
Head 3 Playback Off/On	23	0, 127	(0=off, 1-127=on)
Head 4 Playback Off/On	24	0, 127	
Head 1 Level	25	0-127	
Head 2 Level	26	0-127	
Head 3 Level	27	0-127	
Head 4 Level	28	0-127	

Continued on next page...

MIDI - Specifications (cont.)

PARAMETERS	CC#	RANGE	NOTES
Head 1 Pan	29	0-127	
Head 2 Pan	30	0-127	
Head 3 Pan	31	0-127	
Head 4 Pan	32	0-127	
Head 1 Feedback Off/On	34	0, 127	(0=off, 1-127=on)
Head 2 Feedback Off/On	35	0, 127	(0=off, 1-127=on)
Head 3 Feedback Off/On	36	0, 127	(0=off, 1-127=on)
Head 4 Feedback Off/On	37	0, 127	(0=off, 1-127=on)
Pause ramp speed	38	0-127	
Spring (level)	39	0-127	
Spring Decay	40	0-127	
SOS mode	41	0, 127	(0=normal, 1-127=SOS)
Pause (no ramp)	42	0, 127	(0=unpause, 1-127=pause)
Pause (ramp)	43	0, 127	(0=unpause, 1-127=pause)
Reverse	44	0, 127	(0=normal, 1-127=reverse)
Infinite Hold (w/ oscillation)	45	0, 127	(0=release, 1-127=hold)
Infinite Hold (w/o oscillation)	46	0-127	(0=release, 1-127=hold)
SOS Repeats Level	47	0-127	
SOS Loop Level	48	0-127	
SOS Record/Splice/Clear	49	any	
Exit SOS Looper	50	any	

Continued on next page...

MIDI - Specifications (cont.)

PARAMETERS	CC#	RANGE	NOTES
MIDI Expression Off/On	60	0, 127	(0=off, 1-127=on)
MIDI Clock Off/On	63	0, 127	(0=off, 1-127=on)
Echo On/Off	78	0, 127	(0=off, 127=on)
Reverb On/Off	79	0, 127	(0=off, 127=on)
Footswitch On	80	0, 127	(0=release, 1-127=press)
Footswitch Favorite	81	0, 127	(0=release, 1-127=press)
Footswitch Tap	82	0, 127	(0=release, 1-127=press)
Persist	83	0, 127	(0=persist off, 1-127=persist on)
Kill Dry	84	0, 127	
Output Sum	85	0, 127	(0=dry off, 1-127=dry on)
Remote Tap	93	any	(0=stereo, 1-127=sum)
Expression Pedal	100	0-127	
Bypass/On	102	0, 127	(0=bypass, 1-127=on)

Output Modes

Depending on how you have Volante connected, the signal routing will be as follows.

MONO IN - MONO OUT

Mono signal (e.g. a guitar or pedal) connected to **LEFT IN**. Dry signal goes from **LEFT IN** to **LEFT OUT**. Processed signal path shown in diagram.

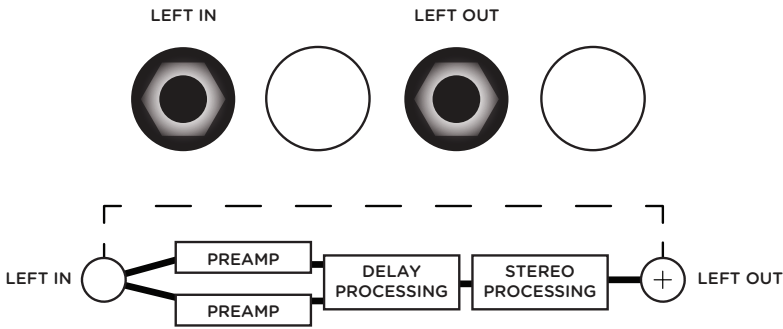

MONO IN - STEREO OUT

Mono signal connected to **LEFT IN**. Dry path goes from **LEFT IN** to both **LEFT OUT** and **RIGHT OUT**.

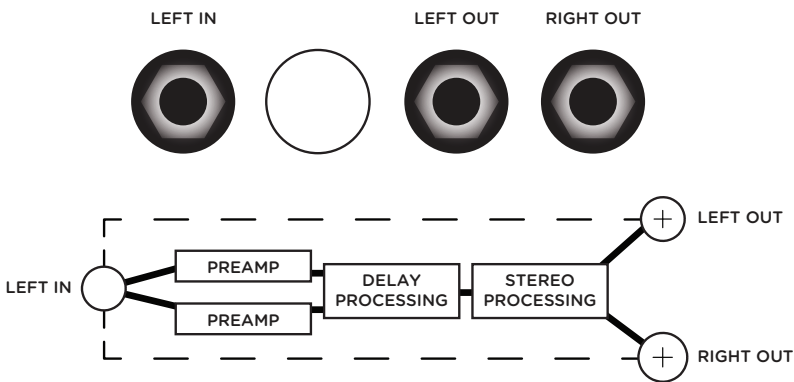

NOTE: With a mono input, the signal is sent to both the left and right analog preamps. This is done to improve the signal to noise ratio.

Output Modes (cont.)

STEREO IN - STEREO OUT

Stereo signal (e.g. a pedal or DAW) is connected to **LEFT IN** and **RIGHT IN**. The stereo dry path goes from **LEFT IN** and **RIGHT IN** to **LEFT OUT** and **RIGHT OUT**.

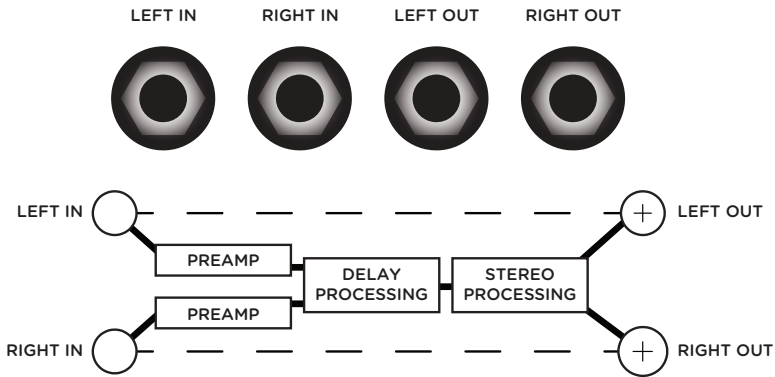

STEREO IN - MONO OUT (SUM MODE)

Stereo signal connected to **LEFT IN** and **RIGHT IN**. The stereo dry path starts from **LEFT IN** and **RIGHT IN**, is summed to mono, and then sent to **LEFT OUT**.

Set **OUTPUT SUM ON/OFF** to On – MONO SUM in Volante's Power Up Modes. (See [page 25](#) for details.)

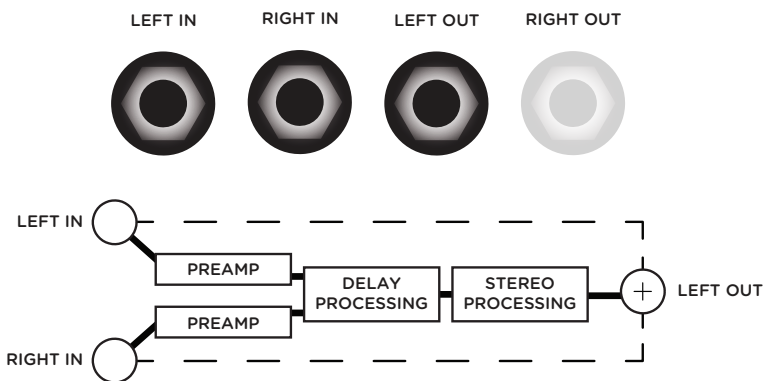

NOTE: If you are using stereo out connections, but would like to output in mono, enable SUM mode to send a summed mono signal to the **LEFT OUT**.

Output Modes (cont.)

STEREO IN - MONO OUT (SUM MODE)

Stereo signal connected to **LEFT IN** and **RIGHT IN**. The stereo dry path starts from **LEFT IN** and **RIGHT IN**, is summed to mono, and then sent to **LEFT OUT**.

Set **OUTPUT SUM ON/OFF** to On – MONO SUM in Volante’s Power Up Modes.

(See [page 25](#) for details.)

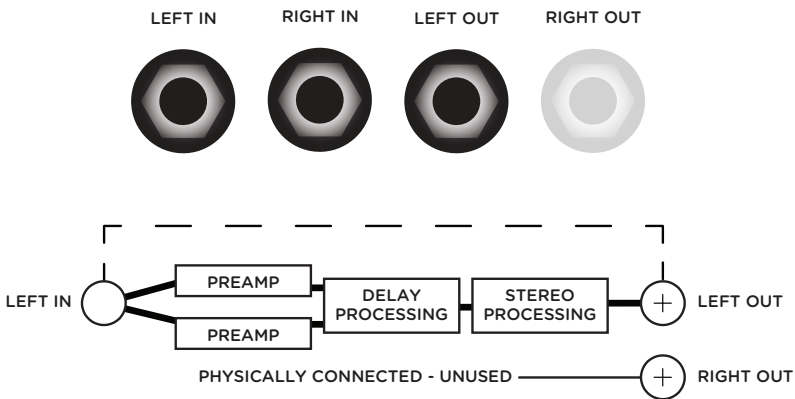

NOTE: In SUM mode, all audio will be routed to the **LEFT OUT** even if a jack is connected to the **RIGHT OUT**. This is useful if you do not want to disconnect a complex stereo rig.

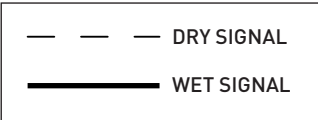

Signal Flow Diagram

Below is a schematic representation of Volante's signal paths.

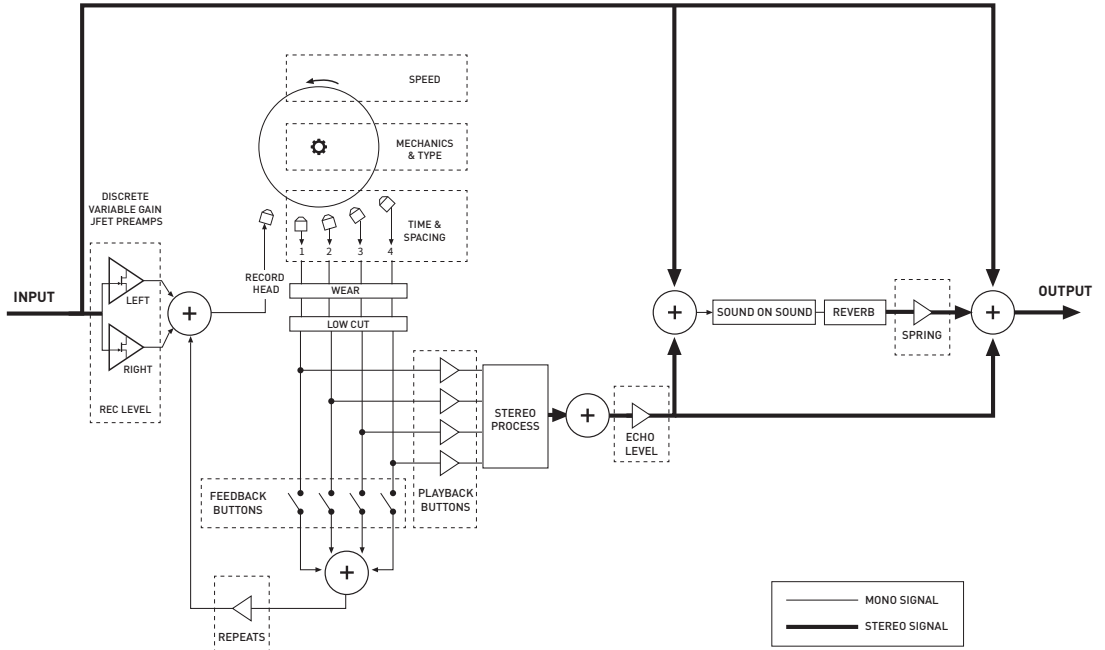

Features

.....

- Multi-head magnetic media delay machine providing four playback heads with individual feedback, panning, and level controls
- Processor-intense algorithms deliver meticulously nuanced recreations of vintage magnetic echo systems (drum echo, tape echo, studio reel-to-reel echo)
- Dedicated control over echo machine tone and media: Low Cut, Mechanics, Wear
- Input Record Level for clean reproduction to warm, fat saturation
- Independent Spring Reverb
- Sound on Sound looping mode with reverse, pause, splice, and infinite repeat functions
- High impedance stereo input
- Stereo output
- Input Level switch allows for both instrument and line level signals
- On, Favorite, and Tap Tempo footswitches
- Expression pedal input allows the connection of an expression pedal, external tap pedal, 1/4" to MIDI cable, or MultiSwitch Plus
- Full featured MIDI in/out supporting MIDI CCs, program changes, and more
- USB jack for controlling MIDI via computer
- Analog dry path for a zero latency dry signal that is never converted to digital
- Premium JFET analog front end
- Ultra low noise, high performance 24-bit 96kHz A/D and D/A converters provide uncompromising audio quality
- Super high performance SHARC DSP
- 32-bit floating point processing

Specifications

.....

Input Impedance	1M Ohm
Output Impedance	100 Ohm
A/D & D/A	24-bit 96kHz
Max Input Level	+8dBu
Frequency Response	20Hz to 20kHz
Signal to Noise	115dB typical
DSP performance	1585 MegaFLOPS
Bypass Switching	True Bypass (electromechanical relay switching)
Dimensions	4.5" deep x 7" wide x 1.75" tall (11.4 cm deep x 10.2 cm wide x 4.4 cm tall)

Power Adapter Requirements

.....

Use an adapter with the following rating: 9VDC center negative; 300mA minimum.

Factory Preset Settings

Preset 1 (playback 1): Middle In

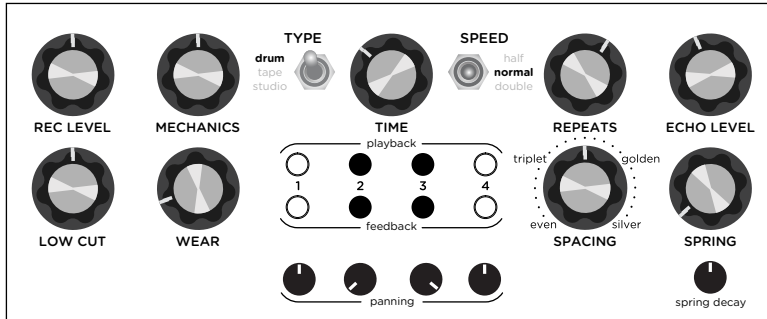

Preset 2 (playback 2): Head-on

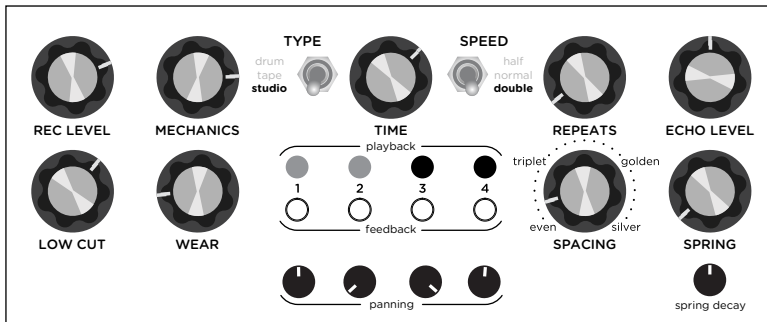

Preset 3 (playback 3): High Pass Tape

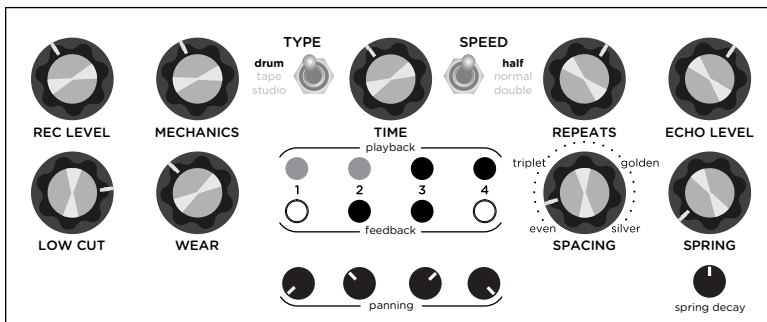

Preset 4 (playback 4): Silken Sea

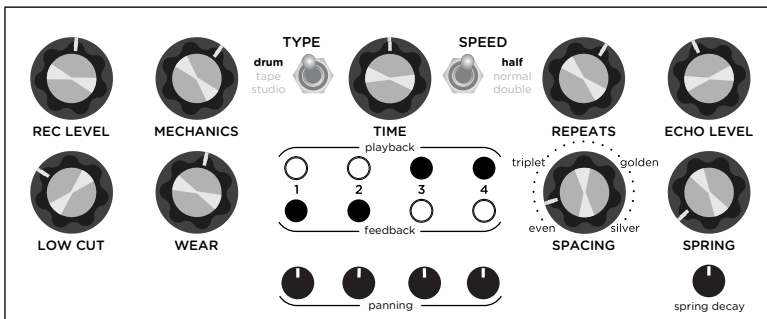

● on ● half volume ○ off

Factory Preset Settings (cont.)

Preset 5 (feedback 1): Tape 123

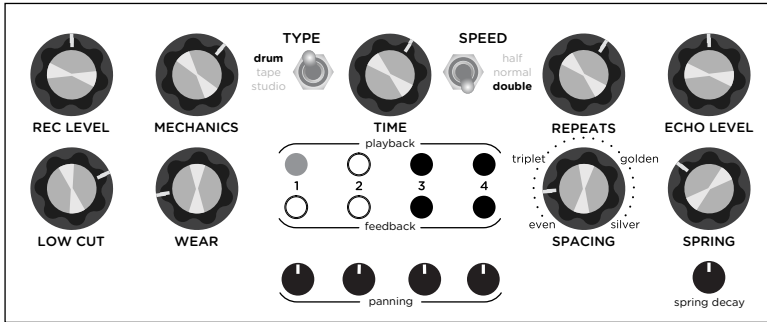

Preset 6 (feedback 2): Studio Regen

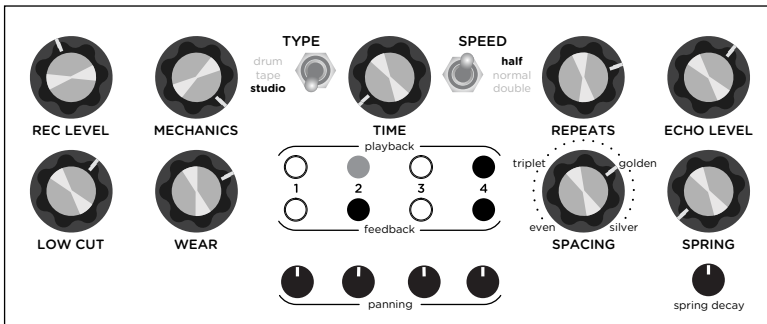

Preset 7 (feedback 3): 3 Headed Drum

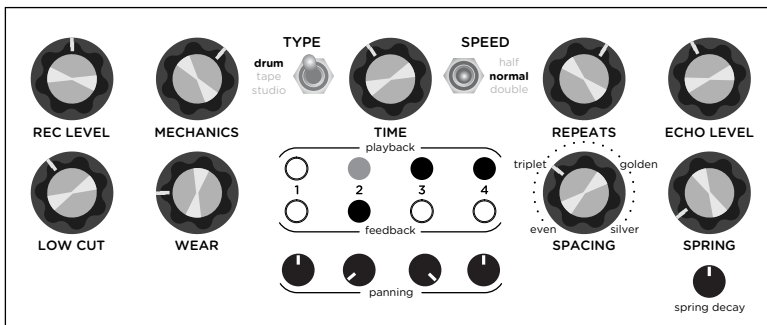

Preset 8 (feedback 4): Tape Dreams

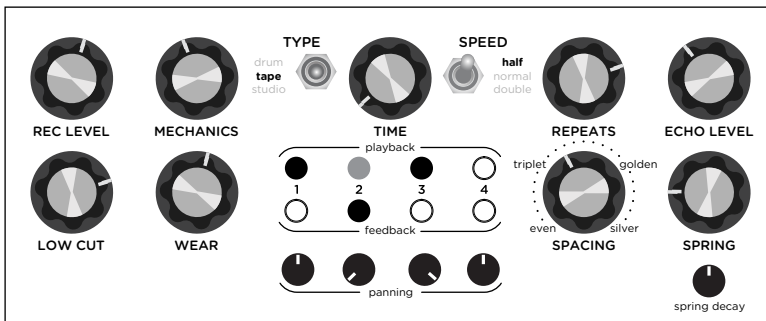

● on ● half volume ○ off

Strymon Non-Transferrable Limited Warranty

.....

Warranty

Strymon warrants the product to be free from defects in material and workmanship for a period of two (2) years from the original date of purchase when bought new from an authorized dealer in the United States of America or Canada. If the product fails within the warranty period, Strymon will repair or, at our discretion, replace the product at no cost to the original purchaser. Please contact your dealer for information on warranty and service outside of the USA and Canada.

Exclusions

This warranty covers defects in manufacturing discovered while using this product as recommended by Strymon. This warranty does not cover loss or theft, nor does the coverage extend to damage caused by misuse, abuse, unauthorized modification, improper storage, lightning, or natural disasters.

Limits of Liability

In the case of malfunction, the purchaser's sole recourse shall be repair or replacement, as described in the preceding paragraphs. Strymon will not be held liable to any party for damages that result from the failure of this product. Damages excluded include, but are not limited to, the following: lost profits, lost savings, damage to other equipment, and incidental or consequential damages arising from the use, or inability to use this product. In no event will Strymon be liable for more than the amount of the purchase price, not to exceed the current retail price of the product. Strymon disclaims any other warranties, expressed or implied. By using the product, the user accepts all terms herein.

How to Obtain Service Under this Warranty

For North American customers: Contact Strymon through our website at strymon.net/support for Return Authorization and information. Proof of original ownership may be required in the form of a purchase receipt.

For International Customers: Contact the Strymon dealer from which the product was purchased from in order to arrange warranty repair service.

Strymon® is a division of Damage Control®, LLC.