

# JBL WB52

Pre-construction bracket for JBL Synthesis SCL-7

JBL

SYNTHESIS

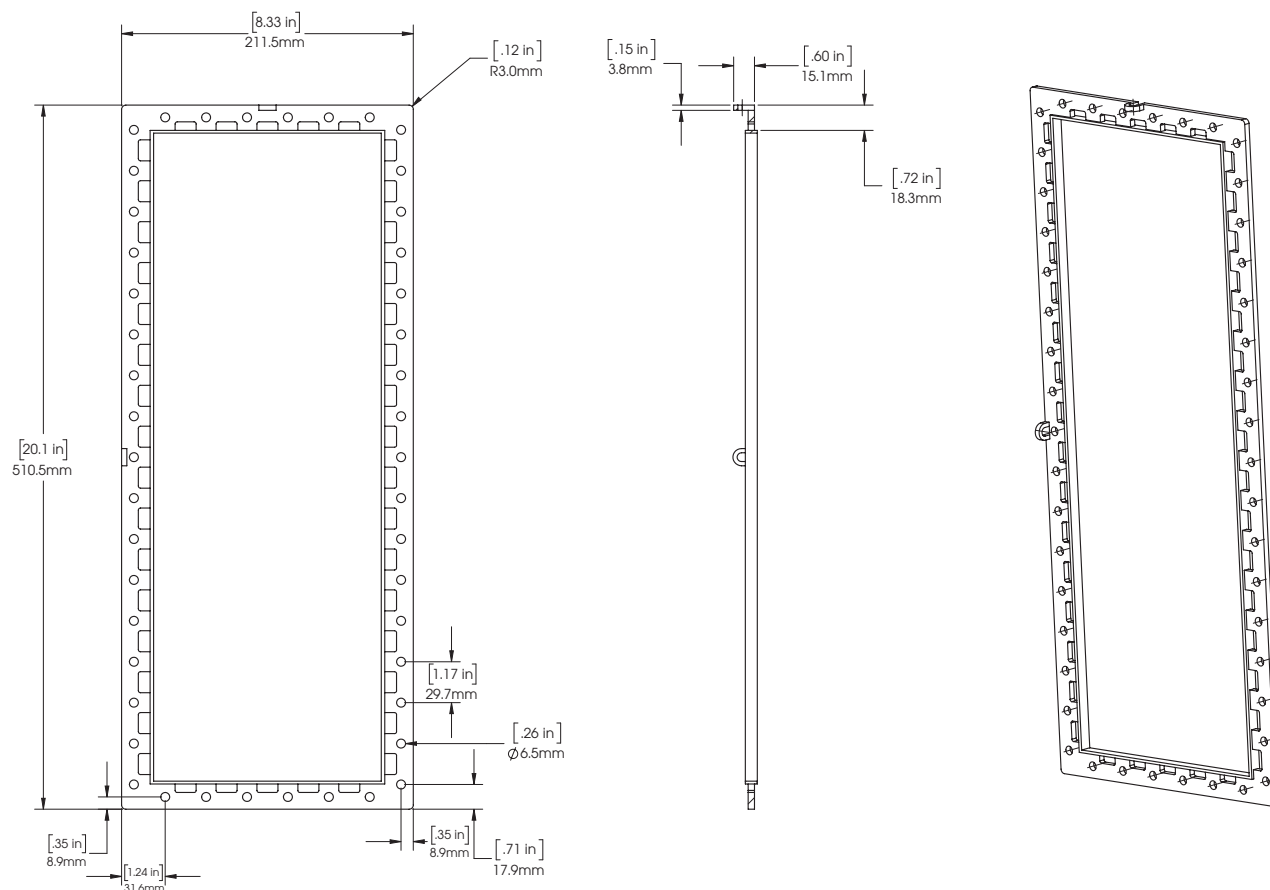

## Features

- For use as part of the installation process for the JBL Synthesis SCL-7 into new construction.
- Designed to be installed during pre-wire and reserve the proper speaker placement as the wallboard is installed over them.
- Specifically sized for JBL Synthesis SCL-7.
- Wire tabs to hold pre-routed speaker wires in-place.
- Packaged and sold individually.

## Instructions

- Determine location of bracket.
- Snap the two flat wing sections onto the frame.
- Install directly to the structural framing prior to the installation of wallboard.
- Use the wire tabs to hold pre-routed speaker wires in place.
- After the wallboard is installed, cut out the hole for the speaker using the inside cut-out of the frame as a guide.
- Mount the JBL Synthesis SCL-7 according to the instructions provided with the speaker.



HARMAN International Industries, Incorporated  
8500 Balboa Boulevard, Northridge, CA 91329 USA  
www.jblsynthesis.com

© 2021 HARMAN International Industries, Incorporated. All rights reserved. JBL Synthesis is a registered trademark of HARMAN International Industries, Incorporated registered in the United States and/or other countries. Features, specifications, and appearance are subject to change without notice.