



ABB i-bus[®] KNX Blind/Roller Shutter Actuators JRA/S Product Manual

Power and productivity
for a better world™



Contents

Page

1	General	3
1.1	Using the product manual.....	4
1.1.1	Structure of the product manual	4
1.1.2	Notes	5
1.2	Product and functional overview.....	6
2	Device technology	7
2.1	JRA/S X.230.5.1 Blind / Roller Shutter Actuator with Travel Detection and Manual Operation, x-fold, 230 V, MDRC	7
2.1.1	Technical specifications.....	7
2.1.2	Connection diagrams JRA/S X.230.5.1	10
2.1.3	Dimension drawing JRA/S X.230.5.1.....	11
2.2	JRA/S 4.24.5.1 Blind / Roller Shutter Actuator with Travel Detection and Manual Operation, 4-fold, 24 V DC, MDRC	12
2.2.1	Technical specifications.....	12
2.2.2	Connection diagram JRA/S 4.24.5.1	15
2.2.3	Dimension drawing JRA/S 4.24.5.1	16
2.3	JRA/S X.230.2.1 Blind / Roller Shutter Actuator with Manual Operation, x-fold, 230 V, MDRC.....	17
2.3.1	Technical specifications.....	17
2.3.2	Connection diagram JRA/S X.230.2.1	20
2.3.3	Dimension drawing JRA/S X.230.2.1	21
2.4	JRA/S X.230.1.1 Blind / Roller Shutter Actuator with Manual Operation, x-fold, 230 V, MDRC.....	22
2.4.1	Technical specifications.....	22
2.4.2	Connection diagrams JRA/S X.230.1.1	24
2.4.3	Dimension drawing JRA/S X.230.1.1.....	25
2.5	Mounting and installation.....	26
2.6	Manual operation.....	28
2.6.1	Display elements	30
2.6.2	Operating controls	30
3	Start-up	31
3.1	Overview.....	31
3.1.1	Conversion	33
3.1.1.1	Procedure.....	34
3.1.2	Copying and exchanging parameter settings.....	35
3.1.2.1	Procedure.....	36
3.1.2.2	<i>Copy/Exchange channels</i> dialog	37
3.2	Parameters	39
3.2.1	Parameter window <i>General</i>	40
3.2.2	Parameter window <i>Manual operation</i>	44
3.2.3	Parameter window <i>Weather alarms</i>	46
3.2.4	Parameter window <i>A: General</i>	49
3.2.5	Parameter <i>Operation mode control with and without slat adjustment</i>	50
3.2.5.1	Parameter window <i>A: Safety/weather</i>	52
3.2.5.2	Parameter window <i>A: Drive</i>	58
3.2.5.3	Parameter window <i>A: Blinds/shutter</i>	63
3.2.5.4	Parameter window <i>A: Functions</i>	71
3.2.5.4.1	Parameter window <i>A: Positions/Presets</i>	72
3.2.5.4.2	Parameter window <i>A: Automatic Sun Protection</i>	75
3.2.5.4.3	Parameter window <i>A: Scene</i>	81
3.2.5.5	Parameter window <i>A: Status messages</i>	83
3.2.6	Parameter <i>Operation mode: Ventilation flaps, switch mode</i>	87
3.2.6.1	Parameter window <i>A: Safety/weather</i>	89
3.2.6.2	Parameter window <i>A: Status messages</i>	93

ABB i-bus® KNX

Contents

3.3	Communication objects.....	95
3.3.1	Summary of communication objects	95
3.3.2	Communication objects <i>General</i>	97
3.3.3	Communication objects, output A...X <i>Control with and without slat adjustment</i>	99
3.3.4	Communication objects Output A...X <i>Operation mode Ventilation flaps, switch mode</i>	107
4	Planning and application	109
4.1	Travel times (blinds, roller shutters, etc.)	109
4.1.1	Automatic travel detection.....	111
4.1.2	Specifying travel times	112
4.1.3	Start-up/coasting delay and minimum run time.....	112
4.2	Blind/slat settings	113
4.3	Safety functions	114
4.4	Positions	116
4.5	Reaction on bus voltage failure.....	119
4.6	Reaction on bus voltage recovery, download and ETS reset.....	119
A	Appendix	121
A.1	Scope of delivery	121
A.2	Code table Scene (8 bit), DPT 18.001	122
A.3	Code table for communication object <i>Status information (Bit 0...7)</i>	123
A.4	Order details	125
A.5	Notes	126

1 General

Modern building installation offers a high degree of functionality and simultaneously complies with increased security requirements. Due to the structured installation of the electrical components, it is possible to carry out rapid planning, installation and set-up as well as achieve cost benefits during operation.

A whole host of demands are placed on the sun protection devices:

- Anti-glare protection e.g. PC workstations
- Utilization of daylight by tracking the sun's position and directing available daylight
- Protecting furniture and carpets from fading
- Regulating the room temperature, overheating protection in summer; harvesting the available energy on cold days
- Providing protection from people looking in from the outside
- Protection against intruders.

The role of protection against the sun in buildings is increasing in significance due to increasing energy costs and statutory regulations. With intelligent and automated control via ABB i-bus[®] KNX, the JRA/S Blind / Roller Shutter Actuators play a significant role in the energy efficiency of all kinds of buildings. The potential savings for cooling using automatic blind control were presented in a study by the Biberach University of Applied Sciences:

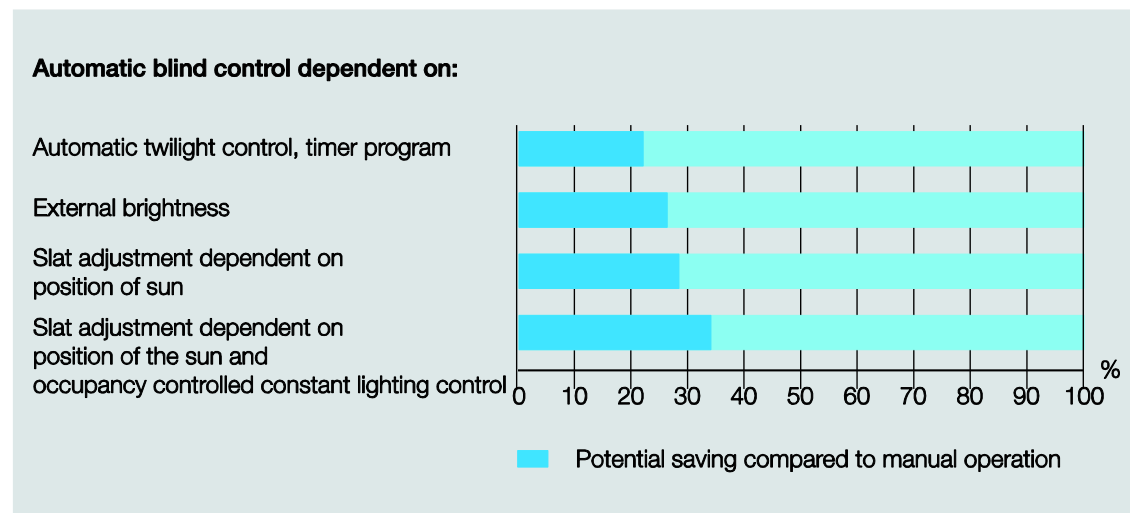

* Determined by the Biberach University of Applied Sciences with ABB i-bus[®] KNX components for usage profile *Open-plan office* (usage profile 3 [DIN V 18599-10:2005-07]) in an example building (classical office building) with the 5S IBP:18599 program. The potential savings relate to the energy consumption. The research results are included in the study *Energy saving and efficiency potential through the use of bus technology as well as room and building automation*, which was undertaken in 2008 for ABB STOTZ-KONTAKT GmbH and Busch-Jaeger Elektro GmbH.

The ventilation of rooms and buildings with ever denser building shells is also becoming ever more important. Fresh air creates a pleasant atmosphere in a room. Ventilation exchanges waste air with oxygen-enriched air and unpleasant odors are expelled from the room. The control of devices and equipment for the supply of fresh air using motors is particularly suitable in places in which the ventilation openings are not manually accessible (e.g. skylights in the ceiling ventilation flaps in the top corner of the room or vertical windows in high rooms). Automatic control is advantageous in rooms which are not used continuously but still need to be ventilated regularly.

The JRA/S Blind / Roller Shutter Actuators make it possible to implement complex requirements for modern sun protection and ventilation control, without losing any comfort, economy and safety.

1.1 Using the product manual

This manual provides detailed technical information on the function, installation and programming of the ABB i-bus® KNX Blind / Roller Shutter Actuator. The application of the device is explained using examples.

This manual is divided into the following chapters:

Section 1	General
Section 2	Device technology
Section 3	Commissioning
Section 4	Planning and application
Section A	Appendix

1.1.1 Structure of the product manual

All parameters are initially described in chapter 3. Directly following the parameter descriptions, you can find descriptions for the communication objects.

The functions of the JRA/S x.y.5.1 Blind / Roller Shutter Actuator with Travel Detection and Manual Operation are explained using the operation mode *Control with slat adjustment*. The device types JRA/S x.y.2.1 and JRA/S x.y.1.1 do not possess some parameters or the corresponding communication objects.

- JRA/S x.y.2.1 does not possess a travel detection function
- JRA/S x.y.1.1 does not possess manual operation nor a travel detection function

The parameters as well as the communication objects, which are not available or are exclusively available in the operation mode *Control without slat adjustment*, are specially marked.

Note

The device features several outputs. However, as the functions for all outputs are identical, only the functions of output A will be described.

1.1.2

Notes

Notes and safety instructions are represented as follows in this manual:

Note
Tips for usage and operation

Examples
Application examples, installation examples, programming examples

Important
These safety instructions are used as soon as there is danger of a malfunction without risk of damage or injury.

Caution
These safety instructions are used if there is a danger of damage with inappropriate use.

 Danger
These safety instructions are used if there is a danger to life and limb with inappropriate use.

 Danger
These safety instructions are used if there is an extreme danger to life with inappropriate use.

1.2 Product and functional overview

The ABB i-bus® Blind / Roller Shutter Actuators are modular installation devices in Pro M Design for installation in distribution boards.

The devices are used to control motors (230 V AC / 24 V DC) for sun protection products, e.g. blinds, roller shutters, vertical blinds, awnings, roller blinds, curtains, etc. The control of blinds/shutters via electrical drives not only saves the user the task of raising and lowering the roller shutters by hand but also enables the implementation of fully automatic control. This type of control takes into consideration the time of day, the strength of the sunlight, the temperature conditions, the wind speed, etc. and positions the blind/shutter in accordance with these factors. The user can adjust this position manually to match their requirements more precisely.

In addition, the devices are suitable for the control of ventilation flaps, skylights, doors, gates and other products controlled via a drive.

The blind/roller shutter actuators are powered via the ABB i-bus® KNX and do not require an additional power supply. The connection to the KNX is established using the bus connection terminal.

The device variants with manual operation, JRA/S X.230.2.1, possess buttons on the front side. They are used to cause the connected drive to adjust the blind/shutter manually, e.g. Move UP/DOWN, STOP and slat OPEN/CLOSE in steps. The LEDs on the front side display the current travel direction, the current end position and the status.

The device variants JRA/S X.230.5.1 and JRA/S 4.24.5.1 also offer manual operation using automatic travel detection via current detection.

On all the 230 V AC blind/roller shutter actuators, the output contacts for the UP/DOWN travel directions are interlocked electromechanically. Voltage applied simultaneously can lead to destruction of the drives. The electromechanical interlocking ensures that voltage can never be present at both contacts simultaneously. The pause on change in direction can be set using parameters.

The reaction on bus voltage failure and recovery and during programming can be set individually.

Type designation

Example JRA/S 4.230.5.1

JRA/S	w	x	y	z
Number of outputs	4			
Nominal voltage		230		
Hardware property			5	
Version				1

w: Number of outputs (2, 4, or 8)

x: Nominal voltage (24 V or 230 V)

y: Hardware property

1 = Standard

2 = With manual operation

5 = With automatic travel detection and manual operation

z: Hardware version

2 Device technology

2.1 JRA/S X.230.5.1 Blind / Roller Shutter Actuator with Travel Detection and Manual Operation, x-fold, 230 V, MDRC

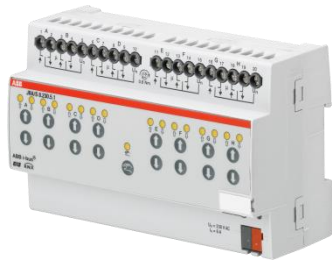

JRA/S 8.230.5.1

The 2, 4 and 8-fold blind/roller shutter actuators with automatic travel detection control 230 V AC drives, acting independently of one another, to position blinds, roller shutters, awnings and other blinds/shutters via ABB i-bus® KNX. In addition, the devices control, for example, ventilation flaps, gates and windows. The travel times of the drives are detected automatically via end position detection and are saved.

As protection against damage to the drives, the output contacts are interlocked electromechanically.

The outputs can be directly controlled on the device using the manual pushbuttons. The LEDs on the front of the device signal the status of the outputs. The devices require no separate auxiliary voltage.

Individual outputs can be copied or exchanged to reduce the programming effort.

The blind/roller shutter actuators are modular installation devices for installation in the distribution board on 35 mm mounting rails. The connection to the ABB i-bus® is implemented via bus connection terminals.

2.1.1 Technical specifications

Supply	Operating voltage	21 ... 30 V DC via KNX		
	Current consumption KNX	< 12 mA		
	Power consumption KNX	Maximum 250 mW		
Outputs	JRA/S type	2.230.5.1	4.230.5.1	8.230.5.1
	Number of outputs UP/DOWN	2*	4	8
		(Interlocked electromechanically)		
		* independent outputs for up to 2 drives each in parallel operation.		
	U _N rated voltage	Maximum 230 V AC, 45 ... 65 Hz		
	I _N rated current	6 A		
	Current detection for travel direction	> 300 mA		
	Maximum switching current	6 A (AC1/AC3) at 230 V AC or 6 A (AC1/AC3) at 400 V AC		
	Minimum switching current	100 mA at 5 V or 10 mA at 10 V or 1 mA at 24 V		
	Leakage loss per device at max. load	< 2 W	< 2 W	< 4 W
Connections	Drives (terminals, output A...X)	For each output, 2 screw terminals (UP/DOWN) with universal head		
	Phase L1...L3 (terminal U _N)	2 or 4 screw terminals with universal head Rigid 0.2...6 mm ² , flexible 0.2...4 mm ²		
	Conductor cross-sectional area, screw terminals	Flexible with wire end ferrules without/with plastic sleeve 0.25...4 mm ²		
	Tightening torque	Max. 0.6 Nm		
	ABB i-bus® KNX	Bus connection terminal (black/red), 0.8 mm Ø, single-core		

ABB i-bus® KNX Device technology

Operating and display elements

Button/LED 

For assignment of the physical address

Button  and LED 

For toggling between manual operation / operation via ABB i-bus® and displays

Buttons   and LEDs  

For control (travel UP/DOWN, slat OPEN/CLOSED) of the output and display of the status

Two buttons and LEDs per output

Degree of protection	IP 20	Compliant to EN 60 529		
Safety class	II, in the installed state	Compliant to EN 61 140		
Isolation category	Overvoltage category Pollution degree	III to EN 60 664-1 2 to EN 60 664-1		
KNX safety extra low voltage	SELV 24 V DC			
Temperature range	Operation Storage Transport	-20 °C...+45 °C -25 °C...+55 °C -25...+70 °C		
Ambient conditions	Maximum air humidity	93 %, no condensation allowed		
Design	Modular installation device (MDRC)	Modular installation device, Pro M		
	Dimensions (H x W x D) in mm; JRA/S type	2.230.5.1	4.230.5.1	8.230.5.1
	- Height	90	90	90
	- Width	72	72	144
	- Depth	64.5	64.5	64.5
	Mounting width in units (18 mm modules)	4	4	8
	Mounting depth	64.5	64.5	64.5
Weight without packaging	JRA/S Type	2.230.5.1	4.230.5.1	8.230.5.1
	Weight in kg	0.2	0.25	0.45
Mounting	On 35 mm mounting rail	To EN 60 715		
Mounting position	Any			
Housing/color	Plastic housing, gray	Halogen-free		
Approvals	KNX to EN 50 090-1, -2	Certification		
CE mark	In accordance with the EMC guideline and low voltage guideline			

ABB i-bus[®] KNX

Device technology

Device type	Application program	Maximum number of communication objects	Maximum number of group addresses	Maximum number of associations
JRA/S 2.230.5.1	Blind / roller shutter 2f 230 V travel det. M/...*	69	255	255
JRA/S 4.230.5.1	Blind / roller shutter 4f 230 V travel det. M/...*	129	255	255
JRA/S 8.230.5.1	Blind / roller shutter 8f 230 V travel det. M/...*	249	255	255

* ... = current version number of the application. **Please refer the software information on our homepage for this purpose.**

Note

ETS and the current version of the device application program are required for programming. The current application program is available for download at www.abb.com/knx. After import in the ETS, it is available in the ETS under *ABB/Blind/Switch*. The device does not support the locking function of a KNX device in ETS. If you disable access to all of the project devices by using a *BCU code*, it has no effect on this device. Data can still be read and programmed.

Important

When electronic drives are used, the closed current may not exceed 150 mA, as the automatic travel detection function is otherwise guaranteed. In this case, the travel times must be detected manually for the drives and entered in the ETS parameters. Electronic drives with soft start or soft stop are not suitable for control via JRA/S.

2.1.2 Connection diagrams JRA/S X.230.5.1

Connection to blind and roller shutter drives

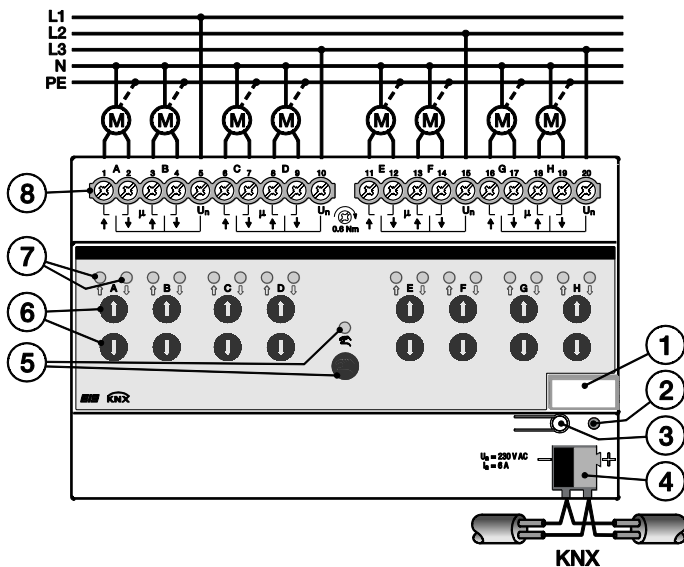

2CDC 072 036 F0010

Connection to ventilation flaps

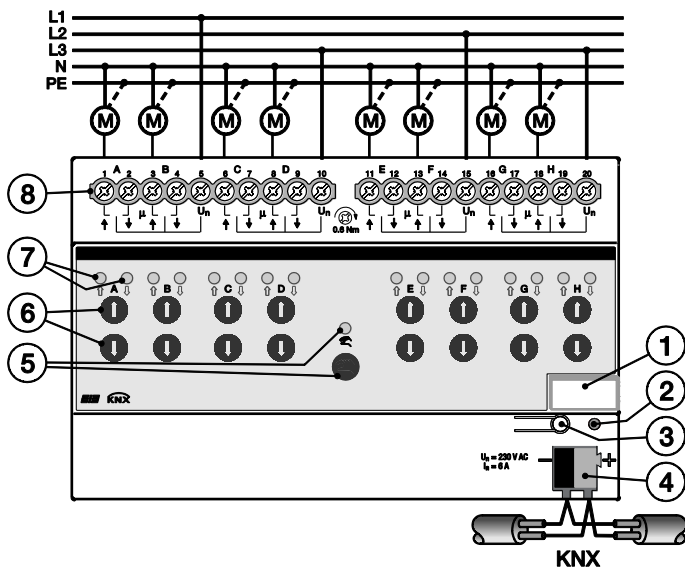

2CDC 072 034 F0010

- 1 Label carrier
- 2 LED ●
- 3 Button
- 4 Bus connection terminal ABB i-bus® KNX
- 5 Button and LED
- 6 Buttons (2 per output)
- 7 LEDs (2 per output)
- 8 Screw terminals (UP/DOWN, Phase L)

ABB i-bus[®] KNX Device technology

2.1.3 Dimension drawing JRA/S X.230.5.1

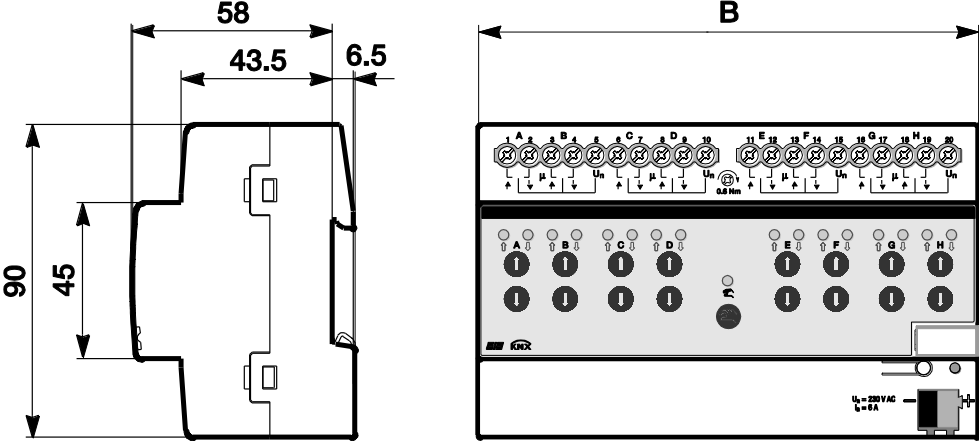

2CDC 072 070 F0010

	JRA/S 2.230.5.1	JRA/S 4.230.5.1	JRA/S 8.230.5.1
B	72	72	144

2.2 JRA/S 4.24.5.1 Blind / Roller Shutter Actuator with Travel Detection and Manual Operation, 4-fold, 24 V DC, MDRC



2CDC 071 019 S0011

JRA/S 4.24.5.1

The 4-fold blind/roller shutter actuator with automatic travel detection controls 24 V AC drives, acting independently of one another, to position blinds, roller shutters, awnings and other blinds/shutters via ABB i-bus® KNX. In addition, the devices control, for example, ventilation flaps, gates and windows. The travel times of the drives are detected automatically via end position detection and are saved.

The devices require no separate auxiliary voltage.

The outputs can be directly controlled on the device using the manual pushbuttons. The LEDs on the front of the device signal the status of the outputs.

Individual outputs can be copied or exchanged to reduce the programming effort.

The blind/roller shutter actuators are modular installation devices for installation in the distribution board on 35 mm mounting rails. The connection to the ABB i-bus® is implemented via bus connection terminals.

2.2.1 Technical specifications

Supply	Operating voltage	21 ... 30 V DC via KNX
	Current consumption KNX	< 12 mA
	Power consumption KNX	Maximum 250 mW
Outputs	Number of outputs (UP/DOWN or +/-)	4
	Potential distribution for UP/DOWN telegram:	
	Output	A B C D
	Terminal no.	1 2 3 4 6 7 8 9
	Potential for DOWN telegram	- + - + - + - +
	Potential for UP telegram	+ - + - + - + -
	U_N rated voltage	Maximum 24 V DC
	I_N rated current	6 A
	Current detection for travel direction	> 50 mA
	Maximum switching current	6 A (AC1/AC3) at 230 V AC or 6 A (AC1/AC3) at 400 V AC
Minimum switching current	100 mA at 5 V or 10 mA at 10 V or 1 mA at 24 V	
Leakage loss per device at max. load	< 4 W	
Connections	Drives (terminals, output A...X)	For each output, 2 screw terminals (UP/DOWN) with universal head
	Load circuit (+/-)	2 screw terminals with universal head Rigid 0.2...6 mm ² , flexible 0.2...4 mm ²
	Conductor cross-sectional area, screw terminals	Flexible with wire end ferrules without/with plastic sleeve 0.25...4 mm ²
	Tightening torque	Max. 0.6 Nm
	ABB i-bus® KNX	Bus connection terminal (black/red), 0.8 mm Ø, single-core

ABB i-bus® KNX

Device technology







Operating and display elements	<p>Button/LED </p> <p>Button  and LED </p> <p>Buttons   and LEDs  </p> <p>Two buttons and LEDs per output</p>	<p>For assignment of the physical address</p> <p>For toggling between manual operation / operation via ABB i-bus® and displays</p> <p>For control (travel UP/DOWN, slat OPEN/CLOSED) of the output and display of the status</p>
Degree of protection	IP 20	Compliant to EN 60 529
Safety class	II, in the installed state	To EN 61 140
Isolation category	Overvoltage category Pollution degree	III to EN 60 664-1 2 to EN 60 664-1
KNX safety extra low voltage	SELV 24 V DC	
Temperature range	Operation Storage Transport	-20 °C...+45 °C -25...+55 °C -25...+70 °C
Ambient conditions	Maximum air humidity	93 %, no condensation allowed
Design	Modular installation device (MDRC) Dimensions (H x W x D) in mm Mounting width in units (18 mm modules) Mounting depth	Modular installation device, Pro <i>M</i> 90 x 72 x 64.5 4 64.5
Weight without packaging	in kg	0.25
Mounting	On 35 mm mounting rail	To EN 60 715
Mounting position	Any	
Housing/color	Plastic housing, gray	Halogen-free
Approvals	KNX to EN 50 090-1, -2	Certification
CE mark	In accordance with the EMC guideline and low voltage guideline	

ABB i-bus[®] KNX

Device technology

Device type	Application program	Maximum number of communication objects	Maximum number of group addresses	Maximum number of associations
JRA/S 4.24.5.1	Blind / roller shutter 4f 24 V travel det. M/...*	129	255	255

* ... = Current version number of the application. **Please refer the software information on our homepage for this purpose.**

Note

ETS and the current version of the device application program are required for programming. The current application program is available for download at www.abb.com/knx. After import in the ETS, it is available in the ETS under *ABB/Blind/Switch*. The device does not support the locking function of a KNX device in ETS. If you disable access to all of the project devices by using a *BCU code*, it has no effect on this device. Data can still be read and programmed.

Important

When electronic drives are used, the closed current may not exceed 150 mA, as the automatic travel detection function is otherwise guaranteed. In this case, the travel times must be detected manually for the drives and entered in the ETS parameters. Electronic drives with soft start or soft stop are not suitable for control via JRA/S.

2.2.2 Connection diagram JRA/S 4.24.5.1

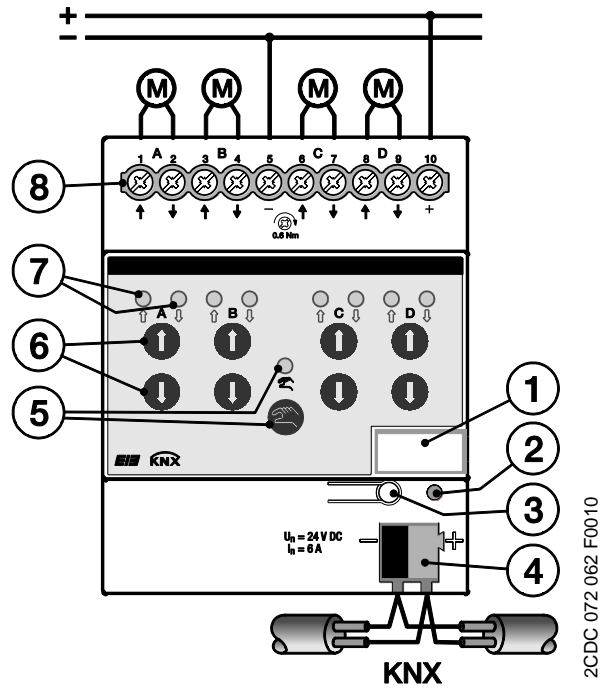

- 1 Label carrier
- 2 LED ●
- 3 Button
- 4 Bus connection terminal ABB i-bus® KNX
- 5 Button and LED
- 6 Buttons (2 per output)
- 7 LEDs (2 per output)
- 8 Screw terminals (UP/DOWN, U_N)

2.2.3

Dimension drawing JRA/S 4.24.5.1

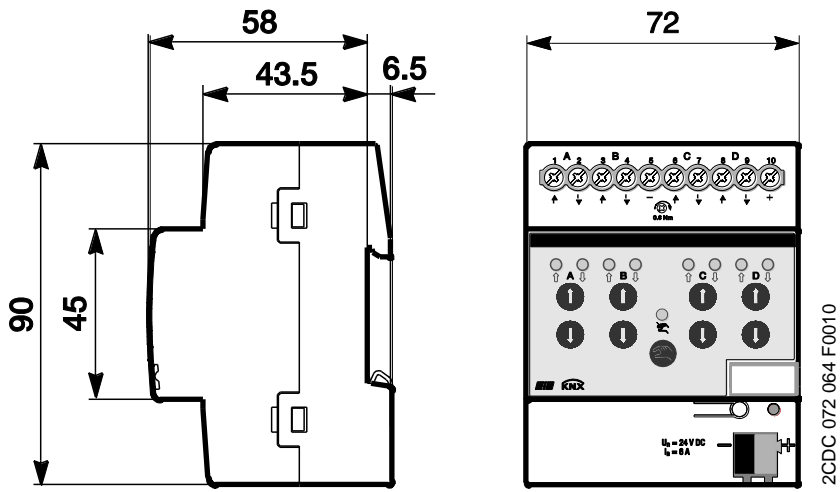

2.3 JRA/S X.230.2.1 Blind / Roller Shutter Actuator with Manual Operation, x-fold, 230 V, MDRC

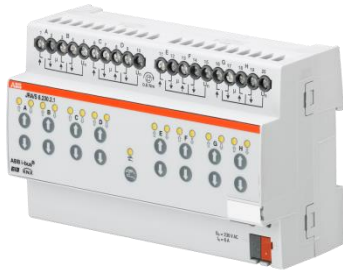

2CDC 071 015 S0011

JRA/S 8.230.2.1

The 2, 4 and 8-fold blind/roller shutter actuators with manual operation control 230 V AC drives, acting independently of one another, to position blinds, roller shutters, awnings and other blinds/shutters via ABB i-bus® KNX. In addition, the devices control, for example, ventilation flaps, gates and windows.

As protection against damage to the drives, the output contacts are interlocked electromechanically.

The devices require no separate auxiliary voltage.

The outputs can be directly controlled on the device using the manual pushbuttons. The LEDs on the front of the device signal the status of the outputs.

Individual outputs can be copied or exchanged to reduce the programming effort.

The blind/roller shutter actuators are modular installation devices for installation in the distribution board on 35 mm mounting rails. The connection to the ABB i-bus® is implemented via bus connection terminals.

2.3.1 Technical specifications

Supply	Operating voltage	21 ... 30 V DC via KNX		
	Current consumption KNX	< 12 mA		
	Power consumption KNX	Maximum 250 mW		
Outputs	JRA/S type	2.230.2.1	4.230.2.1	8.230.2.1
	Number of outputs UP/DOWN	2*	4	8
		(Interlocked electromechanically)		
		* independent outputs for up to 2 drives each in parallel operation.		
	U _N rated voltage	Maximum 230 V AC, 45 ... 65 Hz		
	I _N rated current	6 A		
	Maximum switching current	6 A (AC1/AC3) at 230 V AC or 6 A (AC1/AC3) at 400 V AC		
	Minimum switching current	100 mA at 5 V or 10 mA at 10 V or 1 mA at 24 V		
	Leakage loss per device at max. load	< 2 W	< 2 W	< 4 W
	Connections	Drives (terminals, output A...X)	For each output, 2 screw terminals (UP/DOWN) with universal head	
Phase L1...L3 (terminal U _N)		2 or 4 screw terminals with universal head Rigid 0.2...6 mm ² , flexible 0.2...4 mm ²		
Conductor cross-sectional area, screw terminals		Flexible with wire end ferrules without/with plastic sleeve 0.25...4 mm ²		
Tightening torque		Max. 0.6 Nm		
ABB i-bus® KNX		Bus connection terminal (black/red), 0.8 mm Ø, single-core		

ABB i-bus® KNX Device technology

Operating and display elements

Button/LED 

For assignment of the physical address

Button  and LED 

For toggling between manual operation / operation via ABB i-bus® and displays

Buttons   and LEDs  

For control (travel UP/DOWN, slat OPEN/CLOSED) of the output and display of the status

Two buttons and LEDs per output

Degree of protection	IP 20	Compliant to EN 60 529		
Safety class	II, in the installed state	Compliant to EN 61 140		
Isolation category	Overvoltage category Pollution degree	III to EN 60 664-1 2 to EN 60 664-1		
KNX safety extra low voltage	SELV 24 V DC			
Temperature range	Operation Storage Transport	-20 °C...+45 °C -25 °C...+55 °C -25...+70 °C		
Ambient conditions	Maximum air humidity	93 %, no condensation allowed		
Design	Modular installation device (MDRC)	Modular installation device, Pro M		
	Dimensions (H x W x D) in mm; JRA/S type	2.230.2.1	4.230.2.1	8.230.2.1
	- Height	90	90	90
	- Width	72	72	144
	- Depth	64.5	64.5	64.5
	Mounting width in units (18 mm modules)	4	4	8
	Mounting depth	64.5	64.5	64.5
Weight without packaging	JRA/S Type	2.230.2.1	4,230. 2.1	8.230.2.1
	Weight in kg	0.2	0.25	0.45
Mounting	On 35 mm mounting rail	To EN 60 715		
Mounting position	Any			
Housing/color	Plastic housing, gray	Halogen-free		
Approvals	KNX to EN 50 090-1, -2	Certification		
CE mark	In accordance with the EMC guideline and low voltage guideline			

ABB i-bus® KNX

Device technology

Device type	Application program	Maximum number of communication objects	Maximum number of group addresses	Maximum number of associations
JRA/S 2.230.2.1	Blind / roller shutter 2f 230 V M/...*	69	255	255
JRA/S 4.230.2.1	Blind / roller shutter 4f 230 V M/...*	129	255	255
JRA/S 8.230.2.1	Blind / roller shutter 8f 230 V M/...	249	255	255

* ... = Current version number of the application. **Please refer the software information on our homepage for this purpose.**

Note

ETS and the current version of the device application program are required for programming. The current application program is available for download at www.abb.com/knx. After import in the ETS, it is available in the ETS under *ABB/Blind/Switch*.

The device does not support the locking function of a KNX device in ETS. If you disable access to all of the project devices by using a *BCU code*, it has no effect on this device. Data can still be read and programmed.

Important

Electronic drives with soft start or soft stop are not suitable for control via JRA/S.

2.3.2 Connection diagram JRA/S X.230.2.1

Connection to blind and roller shutter drives

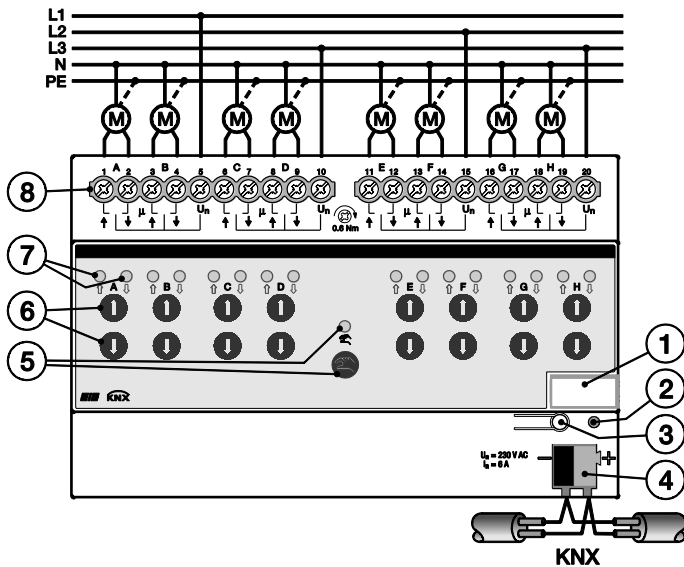

2CDC 072 048 F0010

Connection to ventilation flaps

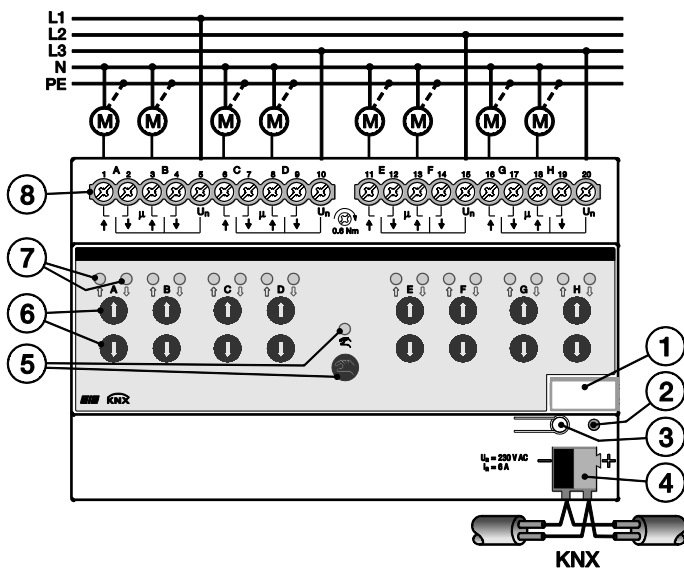

2CDC 072 046 F0010

- 1 Label carrier
- 2 LED ●
- 3 Button
- 4 Bus connection terminal ABB i-bus® KNX
- 5 Button and LED
- 6 Buttons (2 per output)
- 7 LEDs (2 per output)
- 8 Screw terminals (UP/DOWN, Phase L)

ABB i-bus[®] KNX Device technology

2.3.3 Dimension drawing JRA/S X.230.2.1

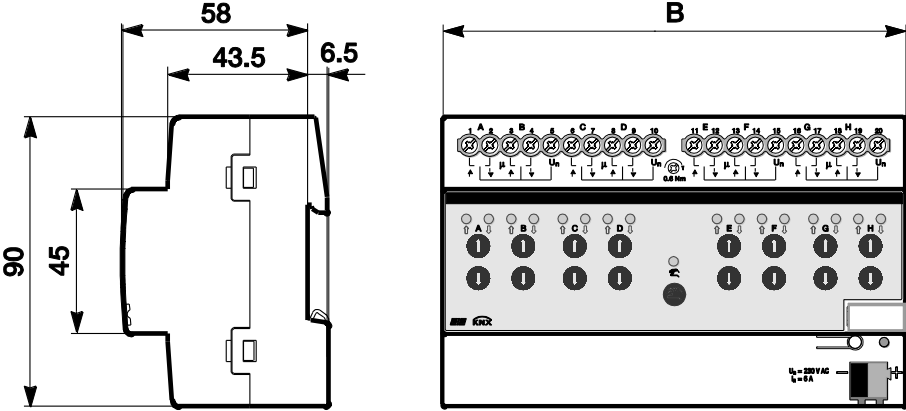

2CDC 072 068 F0010

	JRA/S 2.230.2.1	JRA/S 4.230.2.1	JRA/S 8.230.2.1
B	72	72	144

2.4 JRA/S X.230.1.1 Blind / Roller Shutter Actuator with Manual Operation, x-fold, 230 V, MDRC



JRA/S 8.230.1.1

2CDC 071 012 S001 1

The 2, 4 and 8-fold blind/roller shutter actuators control 230 V AC drives, acting independently of one another, to position blinds, roller shutters, awnings and other blinds/shutters via ABB i-bus® KNX. In addition, the devices control, for example, ventilation flaps, gates and windows.

As protection against damage to the drives, the output contacts are interlocked electromechanically.

The devices require no separate auxiliary voltage.

Individual outputs can be copied or exchanged to reduce the programming effort.

The blind/roller shutter actuators are modular installation devices for installation in the distribution board on 35 mm mounting rails. The connection to the ABB i-bus® is implemented via bus connection terminals.

2.4.1 Technical specifications

Supply	Operating voltage	21 ... 30 V DC via KNX		
	Current consumption KNX	< 12 mA		
	Power consumption KNX	Maximum 250 mW		
Outputs	JRA/S type	2.230.1.1	4.230.1.1	8.230.1.1
	Number of outputs UP/DOWN	2*	4	8
		(Interlocked electromechanically)		
		* independent outputs for up to 2 drives each in parallel operation.		
	U _N rated voltage	Maximum 230 V AC, 45 ... 65 Hz		
	I _N rated current	6 A		
	Maximum switching current	6 A (AC1/AC3) at 230 V AC or 6 A (AC1/AC3) at 400 V AC		
	Minimum switching current	100 mA at 5 V or 10 mA at 10 V or 1 mA at 24 V		
	Leakage loss per device at max. load	< 2 W	< 2 W	< 4 W
	Connections	Drives (terminals, output A...X)	For each output, 2 screw terminals (UP/DOWN) with universal head	
Phase L1...L3 (terminal U _N)		2 or 4 screw terminals with universal head Rigid 0.2...6 mm ² , flexible 0.2...4 mm ²		
Conductor cross-sectional area, screw terminals		Flexible with wire end ferrules without/with plastic sleeve 0.25...4 mm ²		
Tightening torque		Max. 0.6 Nm		
ABB i-bus® KNX		Bus connection terminal (black/red), 0.8 mm Ø, single-core		

ABB i-bus[®] KNX

Device technology

Operating and display elements	Button/LED  •	For assignment of the physical address		
Degree of protection	IP 20	Compliant to EN 60 529		
Safety class	II, in the installed state	Compliant to EN 61 140		
Isolation category	Overvoltage category Pollution degree	III to EN 60 664-1 2 to EN 60 664-1		
KNX safety extra low voltage	SELV 24 V DC			
Temperature range	Operation Storage Transport	-20 °C...+45 °C -25...+55 °C -25...+70 °C		
Ambient conditions	Maximum air humidity	93 %, no condensation allowed		
Design	Modular installation device (MDRC)	Modular installation device, Pro <i>M</i>		
	Dimensions (H x W x D) in mm; JRA/S type	2.230.1.1	4.230.1.1	8.230.1.1
	- Height	90	90	90
	- Width	72	72	144
	- Depth	64.5	64.5	64.5
	Mounting width in units (18 mm modules)	4	4	8
	Mounting depth	64.5	64.5	64.5
Weight without packaging	JRA/S Type	2.230.1.1	4,230. 1.1	8.230.1.1
	Weight in kg	0.2	0.25	0.45
Mounting	On 35 mm mounting rail	To EN 60 715		
Mounting position	Any			
Housing/color	Plastic housing, gray	Halogen-free		
Approvals	KNX to EN 50 090-1, -2	Certification		
CE mark	In accordance with the EMC guideline and low voltage guideline			

Device type	Application program	Maximum number of communication objects	Maximum number of group addresses	Maximum number of associations
JRA/S 2.230.1.1	Blind / roller shutter 2f 230 V/...*	67	255	255
JRA/S 4.230.1.1	Blind / roller shutter 4f 230 V/...*	127	255	255
JRA/S 8.230.1.1	Blind / roller shutter 8f 230 V/...*	247	255	255

* ... = Current version number of the application. **Please refer the software information on our homepage for this purpose.**

Note
<p>ETS and the current version of the device application program are required for programming. The current application program is available for download at www.abb.com/knx. After import in the ETS, it is available in the ETS under <i>ABB/Blind/Switch</i>.</p> <p>The device does not support the locking function of a KNX device in ETS. If you disable access to all of the project devices by using a <i>BCU code</i>, it has no effect on this device. Data can still be read and programmed.</p>

Important
Electronic drives with soft start or soft stop are not suitable for control via JRA/S.

ABB i-bus[®] KNX Device technology

2.4.3 Dimension drawing JRA/S X.230.1.1

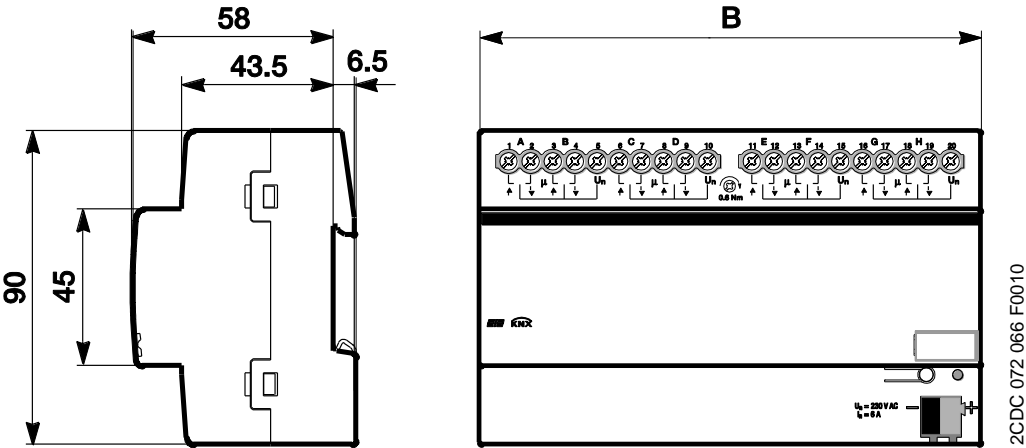

	JRA/S 2.230.1.1	JRA/S 4.230.1.1	JRA/S 8.230.1.1
B	72	72	144

2.5 Mounting and installation

The ABB i-bus® KNX JRA/S Blind / Roller Shutter Actuator is a modular installation device for quick installation in distribution boards on 35 mm mounting rails to DIN EN 60 715.

The mounting position can be selected as required.

The connection to the bus is implemented using the supplied bus connection terminal.

The electrical connection is implemented using screw terminals. The connection to the bus is implemented using the supplied bus connection terminal. The terminal assignment is located on the housing.

The device is ready for operation after connection to the bus voltage. If bus voltage is not yet available at the time of commissioning, the devices can be supplied with power for operation of the manual pushbuttons using the Power Supply NTI/Z.

Accessibility to the device for the purpose of operation, testing, visual inspection, maintenance and repair must be provided compliant to VDE 0100-520.

Commissioning requirements

In order to commission the device, a PC with ETS and a KNX interface, e.g. USB or IP, are required. The device is ready for operation after connection to the bus voltage.

Mounting and commissioning may only be carried out by electrical specialists. The appropriate standards, guidelines, regulations and specifications for your country should be observed when planning and setting up electrical installations and security systems for intrusion and fire detection.

Protect the device from moisture, dirt and damage during transport, storage and operation.

Only operate the device within the specified technical data!

The device should only be operated in an enclosed housing (distribution board)!

The voltage supply to the device must be switched off before mounting work is performed.



Danger

To avoid dangerous touch voltages which originate through feedback from differing phase conductors, all poles must be disconnected when extending or modifying the electrical connections.

Manual operation

The device incorporates manual operating features. Special device functions can be undertaken using the operating keys on the foil keypad.

The foil keypad may not be operated with pointed or sharp-edged objects, e.g. screwdrivers or pens. This may damage the keypad.

Supplied state

The device is supplied with the physical address 15.15.255. The application program is preloaded. It is therefore only necessary to load group addresses and parameters during commissioning.

However, the complete application program can be reloaded if required. A longer downtime may result if the application program is changed or after a discharge.

Assignment of the physical address

The assignment and programming of the physical address is carried out in ETS.

The device features a *Programming* button for assignment of the physical device address. The red *Programming* LED lights up after the button has been pressed. It goes off as soon as ETS has assigned the physical address or the *Programming* button is pressed again.

Cleaning

If devices become dirty, they can be cleaned using a dry cloth or a cloth dampened with a soapy solution. Corrosive agents or solutions should never be used.

Download response

The progress bar for download may take up to 1.5 minutes to appear, depending on the PC that is used, because of the complexity of the device.

Maintenance

The device is maintenance-free. No repairs should be carried out by unauthorized personnel if damage occurs, e.g. during transport and/or storage.

2.6 Manual operation

General

The outputs can be directly controlled using the buttons in manual operation.

Accordingly, the wiring of the drives connected to the outputs can be verified during commissioning. You can, for example, ensure that the connected blind drives move up and down correctly. If bus voltage is not yet available at the time of commissioning, the device can be supplied with power for manual operation using the Commissioning Power Supply NTI/Z.



Function of manual operation

Manual operation facilitates on-location operation of the device. As standard, the button  *Manual operation* is enabled and can be switched on and off using it.

Switch-on of manual operation:

Press button  until the yellow LED  lights continuously.

Switch-off of manual operation:

Press button  until the yellow LED  switches off.

The yellow LED  flashes during the switchover process.

After connection to the KNX, an ETS download or ETS reset, the device is in *KNX operation*. The LED  is off. All LEDs indicate the current state.

Note

If *Manual operation* is generally disabled or disabled via communication object *Disable/enable manual operation*, the LED  flashes during the button push.

A switchover from *KNX operation* to the *Manual operation* mode does not occur.

Important

Safety telegrams such as weather alarms, blocking and forced operation have the highest priority and block manual operation. This is carried out if manual operation is activated and a safety telegram is received. The reaction after bus voltage recovery, programming or ETS reset can be set using the ETS parameters.

Supplied state

Manual operation is enabled by default in the supplied state. The device is in *KNX operation* after connection to the bus. The yellow LED  is off. All LEDs for the outputs indicate the current state. The buttons for the outputs are non-functional.

Telegram processing with active manual operation

Incoming safety telegrams such as Weather alarms, Block and Forced operation have the highest priority and are implemented. All other commands are received and stored. After manual operation is deactivated, the device will update.

If a telegram with the value 1 is received via the communication object *Disable/enable manual operation*, active manual operation is deactivated and then blocked. Manual operation can no longer be activated by the manual buttons.

Electromechanically-locked contacts

The output contacts (UP/DOWN) are interlocked electromechanically. This ensures that voltage can never be present at both contacts simultaneously. Voltage at both contacts can lead to destruction of the drives.

Reversing time, pause between two movement actions

To ensure that the connected drive is not damaged by a sudden change in direction, the output contacts are electrically disconnected for the duration of the programmed reversing time. Only then is the output contact for the required direction of movement switched.









Important
<p>The technical data of the appropriate drive manufacturer must be observed when programming the reversing time (operation modes <i>Control with/without slat adjustment</i>)!</p> <p>In the operation mode <i>Ventilation flap, switch mode</i>, a reversing time of 100 ms is predefined and cannot be parameterized.</p>

2.6.1 Display elements

Indicator LEDs are located on the front of the device.

All LEDs *Output X* indicate the actual state. In *KNX operation* the LED  is off.

The response of the display elements is described in the following table:



LED	KNX operation	Manual operation
 Manual operation	<i>Off</i> : The device is in KNX operation <i>Flashes (for about 3 seconds)</i> : Changeover to Manual operation. <i>Continuous flashing</i> : The LED flashes for as long as the button  is pressed. The LED  switches off when released.	<i>On</i> : The device is in Manual operation <i>Flashes (for about 3 seconds)</i> : Changeover to KNX operation.
 Output A...X UP/DOWN	<i>On</i>  : Upper end position, contact closed <i>On</i>  : Lower end position, contact open <i>Both LEDs on</i> : Safety function active, e.g. wind alarm  <i>flashes</i> : Blind/shutter moving upwards  <i>flashes</i> : Blind/shutter moving downwards <i>Both LEDs flashing alternately*</i> : Fault - drive error (no current flow or invalid travel times) <i>Off</i> : Intermediate position	

* Only for devices of type JRA/S x.y.5.1

2.6.2 Operating controls

Buttons for manual operation are located on the front of the device.

The reaction of the operating elements is described in the following table, according to the operating states, *KNX operation* and *Manual operation*:

Button	KNX operation	Manual operation
 Manual operation	<i>Long button operation (about 3 sec.)</i> : Switch to <i>Manual operation</i> provided that <i>Manual operation</i> is not blocked by a parameter setting. <i>Short button operation</i> : LED  <i>Manual operation</i> flashes and switches off again. The device is once again in <i>KNX operation</i> .	<i>Long button operation (about 3 sec.)</i> : Changeover to <i>KNX operation</i> . The inputs are queried again, and the input states are updated accordingly.. Reset of the <i>Manual operation</i> to <i>KNX operation</i> can also be completed within a parameterized time depending on the parameterization.
 Output A...X UP/DOWN	No reaction	<i>Long button operation</i> : UP/DOWN or opening/closing of the contact <i>Short button operation</i> : Slat adjustment/STOP

3 Start-up

The central functions of the blind/roller shutter actuators are described in this section. The parameterization of the blind/roller shutter actuator is implemented with the application program and the Engineering Tool Software ETS. Using the application program, a comprehensive and flexible range of functions are available to the device. The standard settings allow simple commissioning. The functions can be extended if required.

The application program can be found at *ABB/Blind/Switch*.

For parameterization purposes, a PC or Laptop with ETS and a connection to the KNX, e.g. USB or IP interface, is required.

3.1 Overview

Overview of the functions in a tabular form.

JRA/S characteristics	X.230.5.1	4.24.5.1	X.230.2.1	X.230.1.1
Hardware				
Number of Outputs	X = 2, 4, 8	4	X = 2, 4, 8	X = 2, 4, 8
Nominal voltage	230 V AC	24 V DC	230 V AC	230 V AC
Installation type	MDRC	MDRC	MDRC	MDRC
Module width (in space units)	2-fold, 4-fold: 4 space units, 8-fold: 8 space units	4	2-fold, 4-fold: 4 space units, 8-fold: 8 space units	2-fold, 4-fold: 4 space units, 8-fold: 8 space units

■ = Characteristic applies

General parameterization options	X.230.5.1	4.24.5.1	X.230.2.1	X.230.1.1
Manual functions				
Disable/enable manual operation	■	■	■	-
Status Manual operation	■	■	■	-
Operating modes				
Control with slat adjustment (blind etc.)	■	■	■	■
Control without slat adjustment (shutters, awning, etc.)	■	■	■	■
Ventilation flaps, switch mode	■	■	■	■
General device functions				
Automatic travel detection	■	■	-	-
Time-delayed switching of drives	■	■	■	■
Limit rate of telegrams	■	■	■	■
Transmission and switching delay	■	■	■	■
In operation function	■	■	■	■
Request status values	■	■	■	■
Ventilation flaps, switch mode	■	■	■	■
Extended setting options for drives and blinds/shutters	■	■	■	■
Continued overleaf				

General parameterization options	X.230.5.1	4.24.5.1	X.230.2.1	X.230.1.1
Direct functions				
UP/DOWN/STOP	■	■	■	■
Slat adjustment	■	■	■	■
Position height/slat [0...255]	■	■	■	■
Preset Move to position/Set position	■	■	■	■
Limited UP/DOWN	■	■	■	■
Enable limitation	■	■	■	■
Trigger travel detection	■	■	-	-
Trigger reference movement	■	■	■	■
8-bit scene	■	■	■	■
Safety functions				
Wind alarm	■	■	■	■
Rain alarm	■	■	■	■
Frost alarm	■	■	■	■
Disable	■	■	■	■
Forced operation	■	■	■	■
Reaction after bus voltage failure/recovery, programming	■	■	■	■
Automatic functions				
Activation of autom. control	■	■	■	■
Change height/slat position if sunny	■	■	■	■
Presence	■	■	■	■
Heating/cooling	■	■	■	■
Overheat control	■	■	■	■
Enable/disable automatic control	■	■	■	■
Enable/disable direct operation	■	■	■	■
Status messages				
Status Height/slat [0...255]	■	■	■	■
Status Upper/Lower end position	■	■	■	■
Status Operability	■	■	■	■
Status Automatic	■	■	■	■
Status information (2-byte)	■	■	■	■

■ = Characteristic applies

3.1.1

Conversion

For ABB i-bus[®] KNX devices, it is possible to adopt the parameter settings and group addresses from earlier versions of the application program from ETS3.

Furthermore, conversion can be used to transfer the existing parameterization of a device to a different device.

Note
When the term "channels" is used in ETS, it means inputs and/or outputs. To make the language of ETS generally valid for as many ABB i-bus [®] devices as possible, the word channels is used in this document.

Note
If the number of channels of the target device is larger than the number of inputs/outputs of the source device, only the first inputs/outputs of the target device are written with the converted data of the source device. The remaining inputs/outputs retain or are reset to the default values. Default values for newly added parameters are set after conversion.

3.1.1.1

Procedure

- Insert the desired device into your project.
- Import the current application program into the ETS.
- Perform your parameterizations and program the device.
- After you have parameterized a device, you can transfer the settings to a second device.
- Right click the product and select *Plug-in* > *Convert* in the context menu for this purpose.

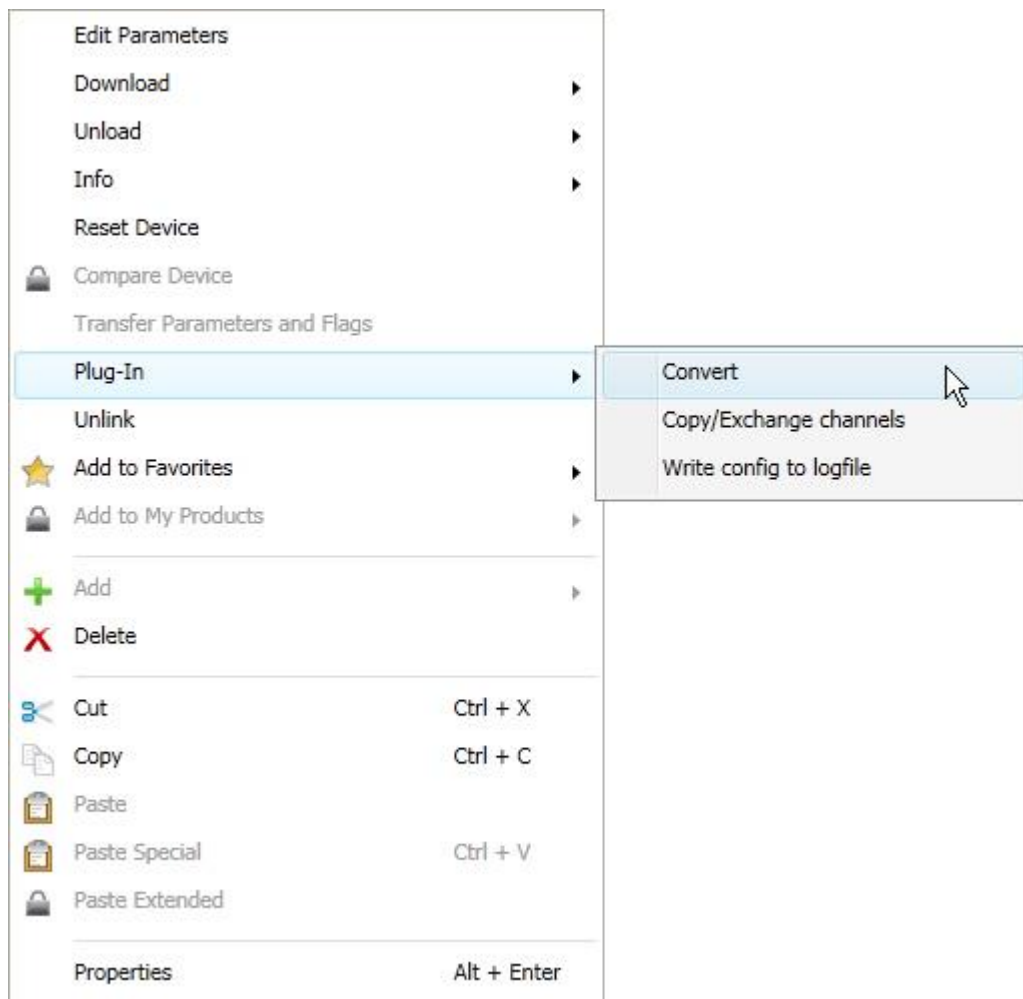

- Then make the desired settings in the *Convert* dialog.
- Finally, you must replace the physical address and delete the old device.

Should you wish only to copy individual inputs/outputs within a device, use the [Copying and exchanging parameter settings function](#), p. 35.

3.1.2 Copying and exchanging parameter settings

Parameterization of devices can take a lot of time depending on the complexity of the application and the number of device inputs/outputs. To keep the commissioning work to the minimum possible, using the function *Copy/exchange channels*, parameter settings of an input/output can be copied or exchanged with freely selectable inputs/outputs. Optionally, the group addresses can be retained, copied or deleted in the target input/output.

Note
When the term "channels" is used in ETS, it always means inputs and/or outputs. To make the language of ETS generally valid for as many ABB i-bus [®] devices as possible, the word channels is used in this document.

The copy function for inputs/outputs is particularly useful with devices having the same parameter settings for several outputs, inputs or groups. For example, lighting in a room is frequently controlled in an identical manner. In this case, the parameter settings of input/output X can be copied to all other inputs/outputs or to a special input/output of the device. Thus the parameters for this input/output need not be set separately, which significantly shortens the commissioning time.

The exchange of parameter settings is useful, e.g. should the inputs/outputs be swapped when wiring the terminals. The parameter settings of the incorrectly wired inputs/outputs can be simply exchanged saving the requirement for time-consuming rewiring.

3.1.2.1

Procedure

- Insert the desired device into your project.
- Import the current application program into the ETS.
- Click with the right mouse button on the product, whose outputs you wish to copy or exchange, and select the context menu *Plug-in > Copy/Exchange channels*.

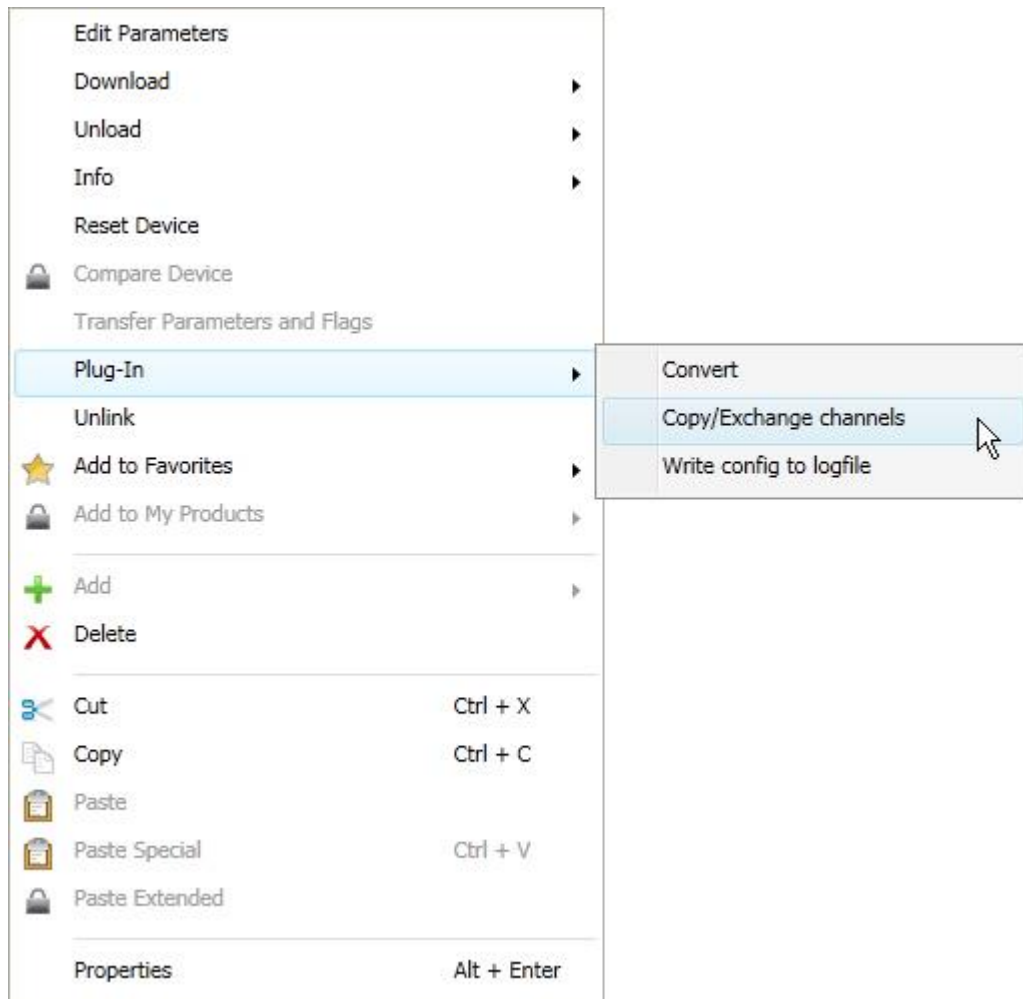

Then make the required settings in the *Copy/Exchange channels* dialog.

3.1.2.2

Copy/Exchange channels dialog

The dialog box is titled "Copy/Exchange channels dialog". It is divided into two main sections: "Source channel" and "Destination channels". Both sections contain a list of channels: "A: General", "B: General", "C: General", and "D: General". Below the "Destination channels" list are "All" and "None" buttons. The dialog also features three radio button options: "Keep group addresses in the destination channel unchanged (if possible)" (selected), "Copy group addresses", and "Delete group addresses in the destination channel". A "Copy" button is next to the second and third options. Below these are three more radio button options: "Exchange without group addresses", "Exchange with group addresses" (selected), and "Delete group addresses". An "Exchange" button is next to the second option. At the bottom are "OK" and "Cancel" buttons.

At the top left, you will see the Source channel selection window for marking the source channel. Beside this is the selection window for the target channel or channels for marking the target channel or channels.



Source channel

The source channel selection defines which parameter settings should be copied or exchanged. Only one source channel can be selected at a time.

Destination channels

By selecting the destination channel(s), you define which channel(s) are to assume the parameter settings of the source channel.

- For the *Exchange* function, only one destination output can be selected at a time.
- For the *Copy* function, various destination channels can be selected simultaneously. For this purpose, press the Ctrl key and mark the required channels with the mouse cursor, e.g. channels B and C.

	With this button, you select all available destination channels, e.g. A...C.
	Reset the selection of the destination channels with this button.

Copy

The following options can be selected before copying the parameter settings:

- Keep group addresses in the destination channel unchanged (if possible)
- Copy group addresses
- Delete group addresses in the destination channel

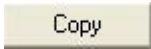
 With this button, copy the settings of the source channel into the destination channel or channels.

Exchange

The following options can be selected before exchanging the parameter settings:

- Exchange without group addresses
- Exchange with group addresses
- Delete group addresses

 With this button, exchange the settings of the source channel with the destination channel.

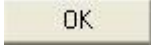
 Confirm your selection with this button, and the window closes.

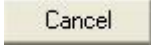
 Using this button, the window closes without accepting the changes.

3.2 Parameters

The parameterization of the devices is performed using the Engineering Tool Software ETS.

The application program is available in the product catalog of the ETS under *ABB/Blind/Switch*.

The default values of the parameters are underlined,

e.g.:

Options: Yes
 No

Possible notes, e.g.:

Note
The device features several outputs. However, as the functions for all outputs are identical, only the functions of output A will be described.

3.2.1 Parameter window *General*

The higher-level parameters can be set in this parameter window.

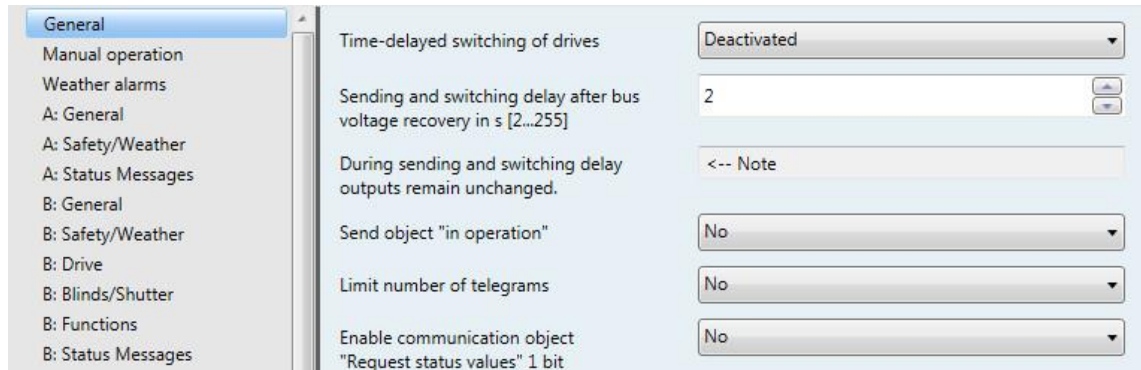

Time-delayed switching of drives

Options: Deactivated
Activated

In larger KNX systems, a high starting current peak is generated if all drives start simultaneously due to central telegrams. The starting current peak can be limited by a time delayed switching of the outputs. The central travel telegrams are executed with a delay. The time delay when implementing a travel movement applies for the following communication objects or states (even for activated automatic control):

- *Move to height for sun [0...255], Adjust slat for sun [0...255] Block, Forced operation*
- *Wind alarm, Rain alarm, Frost alarm*
- *Move to height position [0...255]*
- *Move slats [0...255]*
- *Programming, Reset*
- *Bus voltage failure*
- *Bus voltage recovery*
- *Position on reset of weather alarm, blocking and forced operation*

The time delay when undertaking a movement action is not considered for the following communication objects:

- *Move blinds/shutter up-down, blinds/shutter up-down limited*
- *Slat adjustment/stop up/down, stop*
- *Move to position 1, 2, Move to position 3, 4*

This ensures that the direct operation function, e.g. via a push button, is not time delayed.

- *Activated:* The parameter *Time delay in s* appears.

Time delay in s [1...15]

Options: 1...15

This parameter determines the time delay used by the outputs when they switch successively. The set time delay applies for all outputs or connected drives of the actuator.

Caution

The parameterized time delay also applies for automatic control, weather alarms and forced operations. Therefore, the time delay should only be used in large systems if a mains voltage failure is to be expected when all the drives start-up simultaneously.

Sending and switching delay after bus voltage recovery in s [2...255]

Options: 2...255

During the sending and switching delay, telegrams are only received. The telegrams are not processed, however, and the outputs remain unchanged. No telegrams are sent via the bus.

After the sending and switching delay, telegrams are sent and the state of the outputs is set to correspond with the parameterization or the communication object values.

If communication objects are read out via the bus during the sending and switching delay, e.g. by a visualization system, these read requests are stored, and a response is sent, after the sending and switching delay has been completed.

An initialization time of about two seconds is included in the delay time. The initialization time is the time that the processor requires to be ready to function.

How does the device react on bus voltage recovery?

After bus voltage recovery, the device always waits for the transmission delay time to elapse before sending telegrams via the bus. The parameterized positions are moved to immediately after bus voltage recovery. Incoming telegrams are updated during the switching delay. The most recently received telegram of the highest priority is executed. Manual operation can be executed immediately.

Send object "In operation"

Options: No
Yes

The communication object *In operation* indicates the presence of the device on the bus. This cyclic telegram can be monitored by an external device. If a telegram is not received, the device may be defective or the bus cable to the transmitting device may be interrupted.

- *No*: The communication object *In operation* is not enabled.
- *Yes*: The communication object *In operation* and the following parameters are enabled:

Sending cycle time in s [1...65,535]

Options: 1...60...65,535

Here, the time interval, at which the communication object *In operation* (No. 0) cyclically sends a telegram, is sent.

Object value

Options: $\frac{1}{0}$

The polarity of the object value is set here.

Note

After bus voltage recovery, the communication object sends its value after the set sending and switching delay.

Limit number of telegrams

Options: No
Yes

The load on the bus generated by the device is limited by the telegram rate. This limit relates to all telegrams sent by the device.

- Yes: The following parameters appear:

Max. number of sent telegrams

Options: 1...255

In period

Options: 50 ms/100 ms...1 s...30 s/1 min

These parameters defines the number of telegrams sent by the device within a period. The telegrams are sent as quickly as possible at the start of a period.

Note

The device counts the number of telegrams sent within the parameterized period. As soon as the maximum number of sent telegrams is reached, no further telegrams are sent to the KNX until the end of the period. A new period commences at the end of the previous period. The telegram counter is reset to zero, and sending of telegrams is allowed again. The current communication object value is always sent at the time of sending.

The first period (break time) is not predefined exactly. The period can be between zero seconds and the parameterized time. The subsequent sending times correspond with the parameterized time.

Example:

Maximum number of sent telegrams = 5, in period = 5 s. 20 telegrams are ready to be sent. The device immediately sends 5 telegrams. The next 5 telegrams are sent after maximum 5 seconds. From this point, a further 5 telegrams are sent on the KNX every 5 seconds.

Enable communication object "Request status values" 1 bit

Options: No
 Yes

- Yes: The 1 bit communication object *Request status values* is enabled.

Using this communication object, all the status messages can be requested, provided that they have been parameterized with the option *On change or request*.

With the option Yes, the following parameters appear:

Request with object value

Options: 0
 1
 0 or 1

- 0: Sending status messages is requested with the value 0.
- 1: Sending status messages is requested with the value 1.
- 0 or 1: Sending status messages is requested with the values 0 or 1.

3.2.2 Parameter window *Manual operation*

In this parameter window, all the settings for manual operation can be made. Manual operation and the ETS parameters and communication objects are only available with the devices of type JRA/S x.y.5.1 and JRA/S x.y.2.1.

The screenshot shows the ETS parameter window for 'Manual operation'. The left sidebar lists the navigation menu with 'Manual operation' selected. The main area contains the following settings:



- Manual operation:** Enabled (dropdown menu)
- Reset manual operat. to KNX operation:** Automatically and via push button (dropdown menu)
- Time for automatic reset in s [10...6,000]:** 300 (input field with up/down arrows)
- Enable communication object "Status Man. operation" 1 bit:** No (dropdown menu)
- Safety commands like weather alarms, blocking and forced operation have priority and disable the manual operation!** <-- Note (text box)

Manual operation

Options: Enabled
Disabled
Disable/enable via object

This parameter defines if the switchover between the operating states manual operation and KNX operation is enabled or disabled via the button  on the device.

- **Enabled:** With this selection, the outputs can be directly controlled using the manual buttons.
- **Disabled:** With its selection, manual operation is disabled. The outputs can no longer be operated via the manual buttons.
- **Disable/enable via object:** The communication object *Disable/enable manual operation* appears. Manual operation can be enabled or disabled via the bus with this communication object.



Telegram value: 0 =  button enabled
1 =  button disabled

For further information see: [Manual operation](#), p. 28.

Reset manual operat. to KNX operation

Options: Via push button
Automatically and via push button

This parameter determines for how long manual operation remains activated or after how long switch over to KNX operation occurs. It appears when the parameter option *Disable/enable via object* or *Enable* is selected.

- *Via push button*: Manual operation remains activated until it is deactivated again using the manual operation button  or using the communication object.
- *Automatically and via push button*: Manual operation remains activated after the last operation of the button until the parameterized time has timed out or it is deactivated again using the manual button . The following parameter appears:

Time for automatic reset in s [10...6,000]

Options: 10...300...6,000

Manual operation remains activated until the parameterized time has timed out or it is deactivated again using the manual button .

Enable communication object "Status Man. operation" 1 bit

Options: No
Yes

- Yes: The parameter *Send object value* and the communication object *Status Man. operation* appear.

Send object value

Options: No, update only
On change
On request
On change or on request

- *No, only update*: The status is updated but not sent (the status can be read via the communication object).
- *On change*: The status is sent when a change occurs.
- *On request*: The status is sent when a request occurs.
- *On change or on request*: The status is sent on a change or a request.

Note

Safety telegrams, such as Weather alarms, Block and Forced operation have the highest priority and block manual operation. If a safety telegram becomes active during manual operation, then the parameterized safety position is moved to. Manual operation of the affected output is blocked as long as the safety function is active.

3.2.3 Parameter window *Weather alarms*

All higher level settings affecting the weather alarms are undertaken in this parameter window.

Parameter	Value
Parameter settings	Standard
Order of priority for weather alarm functions	1.Wind alarm - 2.Rain alarm - 3.Frost alarm
Communication object no. 1 for wind alarm	Activated
Communication object no. 2 for wind alarm	Deactivated
Communication object no. 3 for wind alarm	Deactivated
Monitoring period wind alarm in s [0...1,000] (0 = monitoring deact.)	0
Communication object for rain alarm	Deactivated
Communication object for frost alarm	Deactivated
Wind, rain, and frost alarm are active only if a position is set on page "X: Safety/Weather"	<-- Note
Read activated weather alarm objects after bus voltage recovery	No

Parameter settings

Options: Standard
User-defined

Settings on the scope of parameterization can be made here.

- *Standard*: In this setting, there is the option of allocating the output to a communication object for wind alarm. The communication object *Wind alarm No. 1* and the parameter *Monitoring period wind alarm in s* are shown.
- *User-defined*: In this setting, complete parameter access is possible for complex applications. Additional parameters for editing appear.

Order of priority for weather alarm functions

Options: 1.Wind alarm – 2.Rain alarm – 3.Frost alarm
 1.Wind alarm - 2.Frost alarm - 3.Rain alarm
 1.Rain alarm - 2.Wind alarm - 3.Frost alarm
 1.Rain alarm - 2.Frost alarm - 3.Wind alarm
 1.Frost alarm - 2.Rain alarm - 3.Wind alarm
 1.Frost alarm - 2.Wind alarm - 3.Rain alarm

This parameter defines the priority between the weather alarm functions. If more than one weather alarm occurs simultaneously, then only one weather alarm with the highest priority is carried out.

**Communication object no. 1 for
wind alarm**

**Communication object no. 2 for
wind alarm**

**Communication object no. 3 for
wind alarm**

Communication object for rain alarm

Communication object for frost alarm

Options: Deactivated
 Activated

These parameters activate the weather alarm functions and the corresponding communication objects.

- *Activated*: The parameters for the monitoring times of the weather alarms appear.

Note
Wind, rain and frost alarms are only activated when a position for the weather alarm was activated in parameter window <i>A: Safety/Weather</i> . Example: Position on wind alarm Option: Activated - Op

Monitoring period wind alarm in s

Monitoring period rain alarm in s

Monitoring period frost alarm in s

[0...1,000] (0 = monitoring deact.)

Options: 0...1,000

These parameters determine the cyclic monitoring time for wind, rain and frost alarms in seconds.

The weather alarms of the weather sensors are cyclically monitored by the JRA/S.

If the weather sensor sends the telegram value 0, there is no weather alarm. The JRA/S expects this signal. If the signal is not received within the parameterized monitoring period, it can be assumed that the sensor is defective or the bus line has been interrupted. The blind/shutter is moved to the parameterized alarm position. The operation is inhibited.

If the weather sensors send the telegram value 1 (weather alarm), the blind/shutter immediately moves to the parameterized alarm position. The parameter *Monitoring period rain alarm in s* or *Monitoring period frost alarm in s* is displayed, as soon as the parameters *Communication object for rain alarm* or *Communication object for frost alarm* have been set with the option *Activated*.

- 0: Cyclic monitoring is deactivated.

Note
The monitoring period in the JRA/S should be selected to be at least three to four times as large as the cyclic transmission time of the sensor. In this way, the immediate absence of a signal, e.g. due to a high bus load, does not immediately result in the blinds/shutters being moved to the alarm position.

Read activated weather alarm objects after bus voltage recovery

Options: Yes
 No

- Yes: The values of the communication objects *Wind alarm 1...3*, *Rain alarm* and *Frost alarm* are - if activated - read after bus voltage recovery. Should a weather alarm be pending, then the position for the weather alarm is moved to.

Note
Read flags must be set in the sending device.

3.2.4 Parameter window A: General

The general settings for output A are undertaken in this parameter window.

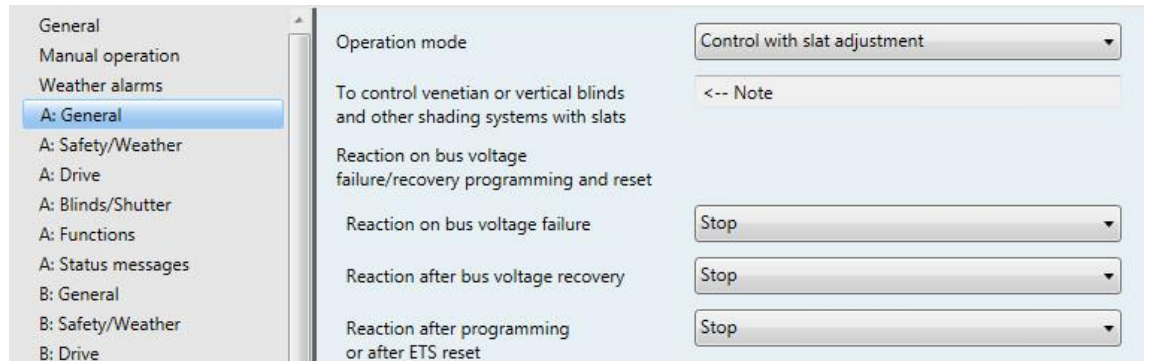

Operation mode

Options: Control with slat adjustment
Control without slat adjustment
Ventilation flaps, switch mode

This parameter defines the operation mode of the output. The communication objects and the parameters for the respective output differ slightly depending on the operation mode. The operation modes *Control with slat adjustment* and *Control without slat adjustment* only differ slightly on account of the slat adjustment functions. For this reason, these are described using the *Control with slat adjustment* operation mode. The parameters as well as the communication objects, which are not available or are exclusively available in the operation mode *Control without slat adjustment*, are specially marked.

You can find the description of the parameters for the operation mode *Ventilation flaps, switch mode* on p. 87 onwards.

3.2.5 Parameter *Operation mode control with and without slat adjustment*

The functions of the JRA/S x.y.5.1 Blind / Roller Shutter Actuator with Travel Detection and Manual Operation are explained using the operation mode *Control with slat adjustment*. The device types JRA/S x.y.2.1 and JRA/S x.y.1.1 do not possess some parameters or the corresponding communication objects.

- JRA/S x.y.2.1 does not possess a travel detection function
- JRA/S x.y.1.1 does not possess manual operation nor a travel detection function

The parameters as well as the communication objects, which are not available or are exclusively available in the operation mode *Control without slat adjustment*, are specially marked.

General	Operation mode	Control with slat adjustment
Manual operation	To control venetian or vertical blinds and other shading systems with slats	<-- Note
Weather alarms	Reaction on bus voltage failure/recovery programming and reset	
A: General	Reaction on bus voltage failure	Stop
A: Safety/Weather	Reaction after bus voltage recovery	Stop
A: Drive	Reaction after programming or after ETS reset	Stop
A: Blinds/Shutter		
A: Functions		
A: Status messages		
B: General		
B: Safety/Weather		
B: Drive		

Reaction on bus voltage failure

Options: No reaction
 Up
 Down
 Stop

The reaction of the output on bus voltage failure is set using this parameter.

- *No reaction*: The output contacts remain in their current position.
- *Up/Down*: The blind/shutter moves upwards or downwards.
- *Stop*: If the blind/shutter is performing a movement, this movement stops immediately. If the blind/shutter is at rest, it will remain unchanged in its position.

Reaction after bus voltage recovery

Reaction after programming or after ETS reset

- Options:
- No reaction
 - Up
 - Down
 - Stop
 - Position 1...4
 - Individual position
 - Enable automatic sun protection

This parameter determines the response of the output on bus voltage recovery or after a download and ETS reset.

- *No reaction*: The output contacts remain in their current position.
- *Up/Down*: The blind/shutter moves up or down.
- *Stop*: If the blind/shutter is performing a movement, this movement stops immediately. If the blind/shutter is at rest, it will remain unchanged in its position.
- *Position 1...4*: If one of these positions are selected, the blind/shutter moves to a preset position. The blind/shutter height and slat setting of the corresponding position can be set in parameter window A: *Positions/Presets*, p. 72).
- *Individual position*: A freely-definable position is moved to. The following parameters appear.

Position height in % [0...100]
(0% = top; 100% = bottom)

Position Slat in % [0...100]
(0% = open; 100% = closed)

Note
The parameters for slat adjustment are available exclusively in the operation mode <i>Control with slat adjustment</i> .

Options: 0...100

These parameters specify the height or the slat position of the blind/shutter.

- *Enable automatic sun protection*: Automatic sun protection is switched on after a bus voltage recovery or after a download and ETS reset.

3.2.5.1 Parameter window A: Safety/weather

In this parameter window, the settings affecting the function Safety/weather are undertaken.

Parameter	Value
Parameter settings	Standard
Output reacts on communication object for wind alarm no.	1
Position on wind alarm	Activated - up
Position on rain alarm	Deactivated
Position for frost alarm	Deactivated
Block	Deactivated
Forced operation (1 bit/2 bit)	Deactivated
Position on reset of weather alarm, blocking and forced operation	No reaction
Position will only be carried out with inactive autom. sun protection	<-- Note
Disable automatic sun protection on reset of safety function	No
Order of priority for safety alarm functions	1.Weather alarm - 2.Block - 3.Forced operation
Wind, rain, and frost alarm are active if objects on page "Weather alarms" are enabled and linked with group addresses	<-- Note

Parameter settings

Options: Standard
User-defined

This parameter defines the scope of parameterization.

- **Standard:** In the case of a wind alarm, the blind/shutter moves to a preset position using the parameter *Position on wind alarm*. This setting is usually sufficient in smaller projects. In this setting, the output only reacts to the communication object *Wind alarm No. 1*.
- **User-defined:** Complete parameter access for complex applications and safety settings of the output are possible. Other parameters appear.

Output reacts on communication object for wind alarm no.

Options: Output does not react to wind alarm
1/ 2/ 3/ 1+2/ 1+3/ 2+3/ 1+2+3

This parameter determines the wind alarm communication objects to which the output reacts. The values of the assigned communication objects are linked by a logic OR.

Position on wind alarm

Position on rain alarm

Position on frost alarm

Options: Activated - no reaction
 Activated – up
 Activated – down
 Activated – stop
 Activated - Position 1...4
 Activated - individual position
 Deactivated

These parameters define the position of the blind/shutter when a weather alarm (wind, rain, frost) is received. The blind/shutter can no longer be operated via other communication objects or by manual operation until the weather alarm has been rescinded. An active travel range limit is taken into account when the weather alarms are carried out.

- *Activated - no reaction*: If the blind/shutter is performing a movement, this movement action to the target position is carried out. If the blind/shutter is at rest, it will remain unchanged in its position.
- *Activated - up*: The blind/shutter moves UP after a weather alarm is received.
- *Activated - down*: The blind/shutter moves DOWN after a weather alarm is received.
- *Activated - stop*: If the blind/shutter is performing a movement, this movement stops immediately. If the blind/shutter is at rest, it will remain unchanged in its position.
- *Activated - Position 1...4*: If one of these positions are selected, the blind/shutter moves to a preset position. The blind/shutter height and slat setting of the corresponding position can be set in parameter window A: *Positions/Presets*, p. 72).
- *Activated - individual position*: A freely-definable position can be moved to. The following parameters appear:

Position Height in % [0...100]
(0% = top; 100% = bottom)

Position Slat in % [0...100]
(0% = open; 100% = closed)

Note
The parameters for slat adjustment are available exclusively in the operation mode <i>Control with slat adjustment</i> .

Options: 0...100

These parameters specify the height or the slat position of the blind/shutter.

- *Deactivated*: In the case of a weather alarm, there is no reaction.

Block

Options: Deactivated
 Activated

This parameter enables the function *Disable*. The blind/shutter moves, for example, to a parameterized position or the operation is blocked. Example: The operation of an internal blind/shutter (internal blind or roller blind) is inhibited if the window is open.

- *Activated*: The communication object *Block* is enabled. The following parameter appears.

Position during blocking

Options: No reaction
 Up
 Down
 Stop
 Position 1...4
 Individual position

This parameter determines the position to be traveled to for the *Block* function.

- *No reaction*: If the blind/shutter is performing a movement, this movement to the target position is carried out. If the blind/shutter is at rest, it will remain unchanged in its position.
- *Up or Down*: The blind/shutter moves UP or DOWN.
- *Stop*: If the blind/shutter is performing a movement, this movement stops immediately. The outputs are disconnected from the voltage supply. If the blind/shutter is at rest, it will remain unchanged in its position.
- *Position 1...4*: If one of these positions are selected, the blind/shutter moves to a preset position. The blind/shutter height and slat setting of the corresponding position can be set in parameter window A: *Positions/Presets*, p. 72).
- *Individual position*: A freely-definable position is moved to. The following parameters appear.

Position Height in % [0...100]
(0% = top; 100% = bottom)

Position Slat in % [0...100]
(0% = open; 100% = closed)

Note
The parameters for slat adjustment are available exclusively in the operation mode <i>Control with slat adjustment</i> .

Options: 0...100

These parameters specify the height or the slat position of the blind/shutter.

- *Deactivated*: In the case of a weather alarm, there is no reaction.

Forced operation (1 bit/2 bit)

Options: Deactivated
 Activated (1 bit)
 Activated (2 bit)

With the *Forced operation* function, the blind/shutter can be moved in a specific direction via a 1-bit telegram or up or down via 2-bit telegrams and the operation can be disabled. For example, the *Forced operation* function can be used to move blinds upwards if the windows are being cleaned or downwards if the slats are being cleaned. At the same time, the operation of the blind/shutter is disabled to ensure that the cleaning personnel are not endangered by an unexpected movement.

- *Activated (1 bit)*: The communication object *Forced operation 1 bit* is enabled. The following parameters appear:

Position Height in % [0...100]
(0% = top; 100% = bottom)

Position Slat in % [0...100]
(0% = open; 100% = closed)

Note
The parameters for slat adjustment are available exclusively in the operation mode <i>Control with slat adjustment</i> .

Options: 0...100

These parameters specify the height or the slat position of the blind/shutter.

With this parameter, the position (position and slat setting) is set which is moved to as soon as Forced operation (1 bit) has been activated. Operation is disabled. If a telegram with the value 0 is received at this communication object, operation is enabled again.

- *Activated (2 bit)*: The communication object *Forced operation 2 Bit* is enabled.

Position on reset of weather alarm, blocking and forced operation

Options: No reaction
 Up
 Down
 Stop
 Position 1...4
 Individual position
 According to object value

This parameter determines the blind/shutter position when rescinding a Weather alarm, Block or Forced operation.

- *No reaction*: If the blind/shutter is performing a movement, this movement to the target position is carried out. If the blind/shutter is at rest, it will remain unchanged in its position.
- *Up*: The blind/shutter moves UP after a safety function is rescinded.
- *Down*: The shutter/blind moves DOWN after a safety function is rescinded.
- *Stop*: If the blind/shutter is performing a movement, this movement stops immediately. If the shutter/blind is at rest, it will remain unchanged in its position.

- *Position 1...4*: If one of these positions are selected, the blind/shutter moves to a preset position. The blind/shutter height and slat setting of the corresponding position can be set in parameter window *A: Positions/Presets*, p. 72).
- *Individual position*: A freely-definable position is moved to. The following parameters appear:

Position Height in % [0...100]
(0% = top; 100% = bottom)

Position Slat in % [0...100]
(0% = open; 100% = closed)

Note
The parameters for slat adjustment are available exclusively in the operation mode <i>Control with slat adjustment</i> .

These two parameters specify the height or the slat position of the blind/shutter.

Options: 0...100

According to object value: During a safety alarm, incoming KNX telegrams are saved to the following communication objects.

Move to height position [0...255]

Move slats [0...255]

Move to position 1, 2

Move to position 3, 4

Scenes

The status of the output is updated to correspond to the current values of the communication objects, e.g. automatic control is activated after the lifting of a safety alarm. If no new telegrams have been received in the meantime, then the blind/shutter is moved to the position in which it was when the safety alarm occurred.

Note
The set position for reset is only moved to when automatic sun protection is deactivated.

Disable automatic sun protection on reset of safety function

Options: Yes
 No

- *No*: After rescinding of a safety function (e.g. wind alarm), automatic sun protection is reactivated.
- *Yes*: After rescinding of a safety function (e.g. wind alarm), automatic sun protection is deactivated.

Order of priority for safety alarm functions

- Options: 1. Weather alarm – 2. Block – 3. Forced operation
1. Weather alarm - 2. Forced operation - 3. Block
1. Block - 2. Weather alarm - 3. Forced operation
1. Block - 2. Forced operation - 3. Weather alarm
1. Forced operation - 2. Block - 3. Weather alarm
1. Forced operation - 2. Weather alarm - 3. Block

This parameter determines the sequence of priorities for the safety functions Weather alarms (wind, rain, frost), Block and Forced operation. These functions have a higher priority than all other functions. If one of these functions is activated, the operation of the blind/shutter is disabled. This also applies during manual operation.

A priority must also be defined for safety functions among one another. In this way, the blind/shutter is correctly controlled if more than one security function is activated simultaneously. Forced operation, for example, has priority over a wind alarm when cleaning the windows, so that the cleaning personnel are not hindered by an UP telegram resulting from a wind alarm.

Note
Wind, rain and frost alarms are only activated if in parameter window <i>Weather alarms</i> , the communication objects are enabled and linked to the group addresses!

3.2.5.2 Parameter window A: Drive

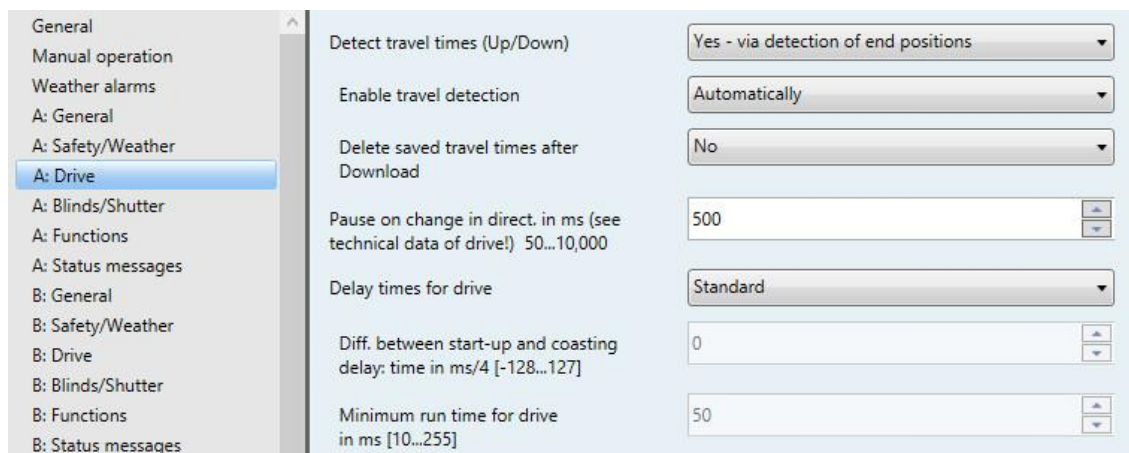

Detect travel times (Up/Down)

Options: Yes - via detection of end positions
 No - set travel times

- *Yes - via detection of end positions*: The parameters for setting and triggering the automatic travel detection appear.

Note			
Automatic travel detection is only available for devices of type JRA/S x.y.5.1.			
In the case of all other types (JRA/S x.y.2.1 and JRA/S x.y.1.1), the parameters for travel time UP or DOWN are shown in the ETS.			
In the case of devices of type JRA/S 4.230.5.1 and JRA/S 8.230.5.1, automatic travel detection via detection of end positions must always be parameterized in pairs for both outputs of a root (e.g. A+B, C+D, etc.). The connected drives should be of the same type or have the same current consumption. Mixed parameterization is not permitted and can lead to errors in travel time detection. Example:			
Parameter	Output A Parameter option	Output B Parameter option	Note
Detect travel times (up/down)	<i>Yes – via detection of end positions</i>	<i>Yes – via detection of end positions</i>	OK
Detect travel times (up/down)	<i>No – set travel times</i>	<i>Yes – via detection of end positions</i>	Not permitted

Note
When electronic drives with a permanent power supply are used, automatic travel detection is not possible, as the current consumption does not take place via the UP or DOWN contact. When electronic drives of this type are used, the travel times must be determined and input manually.

Enable travel detection

Options: Automatically
Autom. or via object "Trigger travel detection"
Via object "Trigger travel detection"

- *Automatically*: The travel times are detected automatically and permanently during operation. In so doing, on each complete movement from end position to end position, the travel times are detected separately via current detection and saved. This compensates length changes in the blind/shutter on account of external influences, e.g. frost, UV radiation or the use of heavy blind/shutter types, during operation. This guarantees exact position of the blind/shutter. In addition, the commissioning time is shortened as there is no manual measurement of the travel times. In addition, the travel time detection is more precise than the specification of the travel times using manually measured values.
- *Autom. or via object "Trigger travel detection"*: In addition to automatic travel detection (as described above), the communication object *Trigger travel detection* appears. Travel detection can be triggered at any time via this communication object. A further parameter appears.
- *Via object "Trigger travel detection"*: The communication object *Trigger travel detection* appears. Travel detection can be triggered at any time via this communication object. A further parameter appears:

Position after travel detection

Options: No reaction, remain in upper end position
Move to position before travel detection

This parameter determines the response of the output when travel time detection is completed.

- *No reaction, remain in upper end position*: The blind/shutter remains in the upper end position after travel detection is completed.
- *Move to position before travel detection*: The blind/shutter moves to the position it had before travel detection began.

Note

Travel detection is also triggered during active automatic control. It interrupts it for the length of travel detection.

After completion of travel detection, the parameterized *Position after travel detection* is executed first. When a new automatic telegram is received, the blind/shutter moves to the automatic position.

Delete saved travel times after Download

Options: Yes
 No

This parameter specifies whether the saved travel times of the output are deleted on a download and overwritten with the preset travel times. The travel times for UP and DOWN are then 60 seconds. Should the travel times be deleted after a download, then the travel times must be detected again. This can take place using the communication object *Trigger travel detection* or automatically during operation through a movement from the lower end position to the top end position and vice-versa.

- *No - Set travel times:* The following parameters appear:

UP time in s [0...6,000]

DOWN time in s [0...6,000]

Options: 0...60...6,000 s

These parameters are used to input the previously measured times, which the blind/shutter requires for a complete movement from the lower end position to the upper end position (UP travel time) and from the upper end position to the lower end position (DOWN travel time). Physical and weathering conditions (frost, UV radiation, long-term use or use of heavy blind/shutter types) mean that, under certain circumstances, differing total travel times may result for a complete movement from the lower end position to the upper end position (UP) and from the upper end position to the lower end position (DOWN). The total travel times (UP/DOWN) can be set separately, allowing accurate positioning of the blind/shutter.

Disconnect output from power after

- Options:
- End position, no overflow
 - End position + 2 % overflow
 - End position + 5 % overflow
 - End position + 10 % overflow
 - End position + 20 % overflow
 - Total travel time + 10 % overflow

After the end position has been reached (as the very top or bottom), the drive will switch off independently. A so-called overflow travel time can be set to ensure that the output safely reaches the end position. The voltage still remains applied for a short time to move the drive to a defined end position in a controlled manner. The basis for the detection of the end position is the position calculated internally in the device.

Enable communication object "Trigger reference movement" 1 bit

- Options:
- Yes
 - No

Reference movements are triggered using this communication object.

- **Yes:** The communication object *Trigger reference movement* is enabled. Slight inaccuracies can occur over longer periods in position detection due to temperature variants and aging processes. For this reason, the upper and the lower end position can be used for clear specification of the current position during position detection. Every time the blind/shutter is in the upper or the lower end position, the position is updated in the memory of the device. If the end positions are not reached in normal operation, a reference movement to the very top or very bottom can be performed via a telegram. After a reference movement, the blind/shutter remains in the reference position or moves back to the position before the reference movement, according to the parameterization. The following parameter appears:

Position after reference movement

- Options:
- No reaction, remain in reference position
 - Move to position before reference movement

This parameter defines how the output should respond after a reference movement.

- **No reaction, remain in reference position:** The blind/shutter remains in the reference position at the very top or very bottom.
- **Move to position before reference movement:** The blind/shutter moves to the position it had before the reference movement. During the reference movement, incoming STOP or step telegrams are ignored and not executed after the reference position has been reached. If automatic control was activated for the blind/shutter before the reference movement, then this will be continued after the reference position has been reached.

Note

A reference movement is also triggered during active automatic control and interrupts this for the duration of the reference movement.

After completion of the reference movement, the parameterized *Position after reference movement* is executed first. When a new automatic telegram is received, the blind/shutter moves to the automatic position.

Pause on change in direct. in ms (see technical data of drive!) 50...10,000

Options: 50...500...10,000

This parameter defines the pause to change direction of the drive in milliseconds.

Caution

The technical data of the drive manufacturer must always be observed!

Delay times for drive

Options: Standard
User-defined

Some drives do not provide the full power immediately but only after a start-up delay of a few milliseconds. Other drives continue to run on for a few milliseconds (coasting delay). For some applications, it may be necessary to compensate delay times when starting and stopping the drive, e.g. blinds/shutters must be positioned exactly.

Note

These parameters must only be entered if you require an even more exact positioning of the blind/shutter. Generally, the basic parameters are adequate to ensure correct operation.

- *Standard:* In this setting, the delay time (0 ms) cannot be changed.
- *User-defined:* The following parameters appear:

Diff. between start-up and coasting delay: time in ms*4 [- 128...127]

Options: -128...0...127

This parameter defines the start-up and coasting delay times of the drive. The value to be entered is calculated from the values of the drive. The value is calculated as follows:

$$(\text{Start-up delay} - \text{Coasting delay}) * 4 = \text{Value}$$

The value has to be an integer number and should be rounded up or down.
The value is indicated in milliseconds (ms).

The multiplication by 4 covers the value range from -512 ms to 508 ms in 4 ms steps ((-512 = -128; -508 = -127; -504 = -126 ... -4 = -1 ; 0 = 0; 4 = 1; ... 500 = 125; 504 = 126; 508 = 127).

Caution

The technical data of the drive manufacturer must always be observed!

Minimum run time for drive in ms [10...255]

Options: 10...50...255

This parameter defines the minimum run time of the drive.

Caution

The technical data of the drive manufacturer must always be observed!

3.2.5.3 Parameter window A: Blinds/shutter

In this parameter window, specific settings for the blind/shutter to be controlled are undertaken.

Note

All the functions and parameters, which relate to settings for slats in the following section, are only available in the operation mode *Control with slat adjustment*.

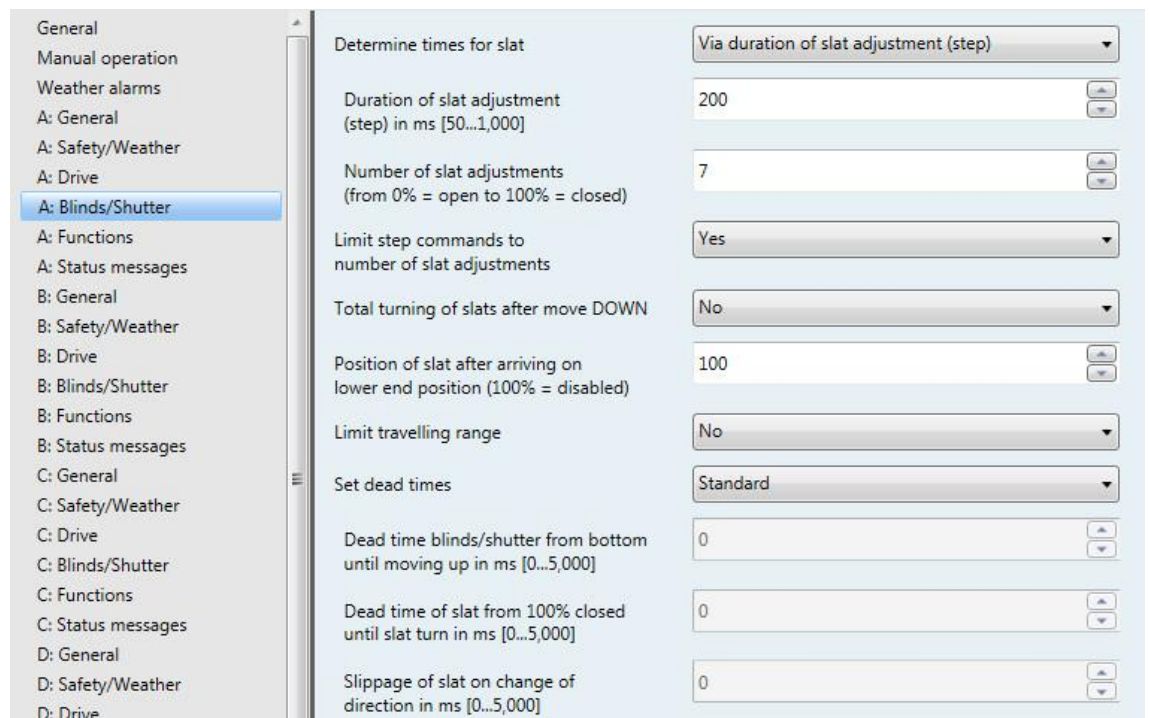

Determine times for slat

Options: Via duration of slat adjustment (step)
Via total duration for slat turning

- *Via duration of slat adjustment (step)*: The following parameters appear:

Duration of slat adjustment (step) in ms [50...1,000]

Options: 50...200...1,000 ms

This parameter specifies the time during which the slats of the blind/shutter, e.g. blind, open or close in each slat adjustment.

Number of slat adjustments (from 0% = open to 100% = closed)

Options: 1...7...60

This parameter defines the number of slat adjustments (steps) which are required to tilt the slats from fully closed to fully open. The appropriate adjustment angle for each slat adjustment is calculated from the duration, slat adjustment and the number of the slat adjustments.

- *Via total duration for slat turning:* This method for determining the slat adjustment times is particularly suitable when high blind/shutter control accuracy is required, e.g. for slat adjustment. Firstly, the time must be determined which the slat requires to tilt from fully closed (100 %) to fully open (0 %). When the total slat turning duration has been determined, only the number required slat adjustments for a complete slat tilt from closed to open must be input. The device calculates the slat adjustment duration automatically.

Example	
Total duration for slat turning:	1500 ms
Number of slat adjustments:	7
Time for slat adjustment (stepped) =	1500 ms / 7 steps ~ <u>214 ms</u>

Note
As times under 50 ms cannot be processed, the calculated time (quotient of the total duration for slat turning and the number of slat adjustments) must always be greater than 50 ms.

The following parameters appear:

**Duration to turn slat from 0% - 100%
in ms [50...60,000]**

Options: 50...1500...60,000

The measured total duration for slat turning is entered here. The time must be determined as precisely as possible to achieve the best possible result for slat position.

**Number of slat adjustments
(from 0% = open to 100% = closed)**

Options: 1...7...60

This parameter defines the number of slat adjustments which are required to tilt the slats from fully closed to fully open. The appropriate duration for a slat adjustment is calculated from the duration of a complete slat turn and the desired number of slat adjustments.

Limit step commands to number of slat adjustments

Options: Yes
 No

This parameter specifies whether step commands are limited to a set number of slat adjustments or whether than can always be executed.

- *Yes*: Only that number of slat adjustments or step commands can be executed as were set in the parameter *Number of slat adjustments [1...60]*.
- *No*: The slat adjustments and step commands of the blind/shutter can be controlled without restriction.

Total turning of slats after move DOWN

Options: Yes
 No

This parameter can be used to release slats which have become stuck or got caught during movement. This functions is primarily used for slats in the pane cavity of a window.

- *Yes*: After a DOWN movement, the slats are turned fully once (CLOSED – OPEN – CLOSED). If a DOWN movement is interrupted by a STOP command, no turn is executed.
- *No*: No action occurs after a DOWN movement.

Position of slat after arriving on lower end position (100% = disabled)

Options: 100 %
 ...
 0 %

This parameter specifies the slat position the blind/shutter is to assume on reaching the lower end position. When blind/shutter has reached to the lower end position, the slats are normally closed.

- *100 %*: The slats are CLOSED.
- *...%*: The slats are moved to the appropriate intermediate position.
- *0 %*: The slats are completely OPEN.

Limit travelling range

Options: No
Via object "Blinds/shutter up-down limited"
Via object "Enable limitation"

For certain applications, the traveling range of the blind/shutter can be limited for the user.

Note

The restriction only works with a telegram to the communication object *Blinds/shutter up-down limited* and with a scene telegram.

The restriction does not apply to:

- Reaction on bus voltage failure, recovery, download and ETS reset
- Manual operation
- Automatic telegrams
- Parameter setting *Move to position via lower/upper end position*
- Reference movement or travel detection

- *Via object "Blinds/shutter up-down limited"*: The communication object *Blinds/shutter up-down limited* is enabled. The following parameters appear:

Upper limit in % [0...100]
(0% = top; 100% = bottom)

Lower limit in % [0...100]
(0% = top; 100% = bottom)

Options: 0...100

These parameters define the upper and lower limit of the travel range.

- *Via object "Enable limitation"*: The communication object *Enable limitation* is enabled. If the restriction was activated via the communication object, then the blind/shutter will move within the specified limits. The following parameters appear:

Upper limit in % [0...100]
(0% = top; 100% = bottom)

Options: 0...100 %

This parameter specifies the upper limit of the travel range.

Upper limit valid for automatic commands

Options: Yes
 No

- *Yes*: The input upper limit of the blind/shutter is taken into account and also executed in the case of automatic telegrams.
- *No*: The upper limit of the blind/shutter is not taken into account in the case of automatic telegrams. The blind/shutter moves to the calculated position.

Upper limit valid for direct commands

Options: Yes
 No

- *Yes*: The input upper limit of the blind/shutter is taken into account and also executed in the case of direct telegrams.
- *No*: The upper limit of the blind/shutter is not taken into account in the case of direct telegrams.

Lower limit in % [0...100] (0% = top; 100% = bottom)

Options: 0...100

The lower limit of the travel range is specified here.

Lower limit valid for automatic commands

Options: Yes
 No

- *Yes*: The input lower limit of the blind/shutter is taken into account and also executed in the case of automatic telegrams.
- *No*: The lower limit of the blind/shutter is not taken into account in the case of automatic telegrams. The blind/shutter moves to the calculated position.

Lower limit valid for direct commands

Options: Yes
 No

- *Yes*: The input lower limit of the blind/shutter is taken into account and also executed in the case of direct telegrams.
- *No*: The lower limit of the blind/shutter is not taken into account in the case of direct telegrams.

Set dead times

Options: Standard
User-defined

- *Standard*: The dead times are deactivated.
- *User-defined*: On some sun protection systems, dead times of the blind/shutter mechanics may occur. They can be caused by aging processes of the blind/shutter, e.g. mechanical load. In such cases, it may no longer be possible to adjust the blind/shutter to precise positions. The following parameters appear for the compensation of various dead times of the blind/shutter.

Dead time blinds/shutter from bottom until moving up in ms [0...5,000]

Options: 0...5,000

This parameter specifies the compensation time which the blind/shutter requires after a travel telegram until the first upward movement.

Examples

The slatted curtain is in the lower end position (= 100 % down). The travel telegram *UP* is received. The motor shaft begins turning. However, the slatted curtain remains in its lower end position until the slatted curtain begins the UP movement after a time X (= dead time).

Dead time of slat from 100% closed until slat turn in ms [0...5,000]

Note

This parameter is available exclusively in the operation mode *Control with slat adjustment*.

Options: 0...5,000

This parameter specifies the compensation time, which is required after a slat adjustment telegram from completely closed (= 100 %) to the first tilt/adjustment of the slat.

Examples

The slats are completely closed (= 100 %). The telegram *Slat adjustment OPEN* is received. The motor shaft begins turning. However, the slat remains closed until the slat begins the tilt/adjustment after a time X (= dead time).

Slippage of slat on change of direction in ms [0...5,000]

Options: 0...5,000 ms

This parameter specifies the time period required for the slat slippage on changing direction, in order to position the slats exactly.

Note

This parameter is available exclusively in the operation mode *Control **with** slat adjustment*.

Examples

The slats are in the horizontal position (50 %). The telegram *Slat adjustment CLOSE* is received. The slat closes to the 60 % position. After this, a *Slat adjustment OPEN* (= change of direction) telegram arrives. The slats position themselves in the 55 % position, but should be in an exactly horizontal position (50 %). Thus, adjusting the parameter compensates for the slat slippage on changing direction, in order to position the slats exactly.

Slippage of blinds/shutter on change of direction in ms [0...5,000]

Note

This parameter is available exclusively in the operation mode *Control **without** slat adjustment*.

Options: 0...5,000

This parameter specifies the time period required for the slippage of the blind/shutter after a change of direction.

Tensioning blinds/shutter or slot positioning

Note

This parameter is available exclusively in the operation mode *Control **without** slat adjustment*.

Options: No
After each DOWN movement
Only after reaching lower end position

This function is used to tauten or tension textile blinds/shutters (e.g. sheet of an articulated arm awning) or to adjust the slot position (e.g. light or ventilation slots) in slatted curtains. In so doing, the blind/shutter is stopped after the end of a DOWN movement and moved in the opposite direction for a parameterizable period of time.

- *No*: The function is deactivated.
- *After each DOWN movement*: The tensioning or slot positioning is executed after each downward movement, also during position movements. A further parameter appears.

- *Only after reaching lower end position:* The tensioning or slot positioning is only executed when the blind/shutter is moving to the lower end position. The following parameter appears:

**Time for tensioning/slot positioning
in ms [0...5,000]**

Options: 0...5,000

This parameter is used to set the time during which the blind/shutter is to be moved in the opposite direction after a DOWN movement.

Note

Tensioning only takes place after a DOWN telegram. When it is activated, then tensioning/slot positioning is triggered by the following types of travel telegrams:

- Direct telegrams (DOWN, Position, Scene...)
- Automatic telegrams
- Manual telegrams via the manual operation buttons
- Safety telegram, e.g. Weather alarm, Forced operation

Here, the above-mentioned travel telegrams must last longer than the time set for tensioning/slot positioning.

The length of tensioning/slot positioning must be shorter than the determined or parameterized total travel time for the DOWN movement.

The tensioning/slot positioning time influences the position calculation and the status communication objects. The value for the current position after tensioning/slot positioning is fed back. Thus, in the case of a travel telegram during active cloth tensioning/slot positioning, a position value smaller than the length of the tensioning is fed back.

Example:

Total travel time DOWN in s	60 s \triangleq 100 %
Position telegram in %	50% \triangleq 30 s
Time for tensioning/slot positioning in s	0.5 s \triangleq [(100 % x 0.5 s / 60 s)] = 0.8 %
Position feedback in %	= 50 % - 0.8 = <u>49.2 %</u>

3.2.5.4 Parameter window **A: Functions**

In this parameter window, the functions *Positions/presets*, *Automatic sun protection* and *8-bit scene* are enabled for each output. A separate parameter window appears for each function.



Enable positions/presets

Options: Yes
No

- Yes: The parameter window *A: Position/presets*, p. 72, is enabled.

Enable automatic sun protection

Options: Yes
No

- Yes: The parameter window *A: Automatic sun protection*, p. 75, and the following communication objects are enabled:
 - *Activation of autom. control*
 - *Sun*
 - *Move to height for sun [0...255]*
 - *Adjust slat for sun [0...255]*

Enable 8 bit scene

Options: Yes
No

- Yes: The parameter window *A: Scene*, p. 81, and the communication object *8 bit scene* are enabled.

3.2.5.4.1 Parameter window A: Positions/Presets

The preset positions are set in this parameter window. In addition, the way in which the positions are to be moved to are also set here.

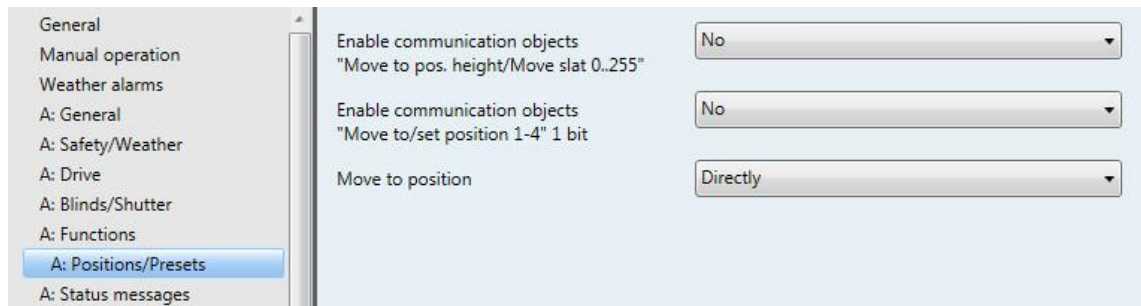

Enable communication objects "Move to pos. height/Move slat [0...255]"

Options: Yes
 No

The blind/shutter can be moved in a targeted manner to any desired position and the slats positioned in any slat position via two separate communication objects. Both communication objects are 1-byte communication objects [0...255].

The following applies to the position of the blind/shutter: The value 0 corresponds to the top position (0 %). The value 255 corresponds to the bottom position (100 %).

The following applies to the slat position: The value 0 corresponds to the open slat position (0 %). The value 255 corresponds to the slat position closed (100 %).

Some of these positions are dependent on the appropriate setting of the drive.

The calculation of the slat position is based on the duration and number of steps.

The calculation of the height is based on the total travel time (via manual measurement and input or via automatic travel detection) of the blind/shutter.

- Yes: The communication objects *Move to pos. height [0...255]* and *Move slats [0...255]* are enabled.

Enable communication objects "Move to/set position 1-4" 1 bit

Options: Yes
 No

Up to 4 preset positions can be set for each output. 2 preset positions (1, 2 or 3, 4) are each moved to using a group address with the values 0 or 1.

This function is particularly suitable for repeated movements to preferred blind/shutter positions, in conjunction with 1 bit telegrams.

The saved preset positions can be very easily changed without programming the device via the KNX. The blinds/shutters must be brought to the new required target position. This new position is applied to the device memory via the communication objects *Set position 1, 2* and *3, 4* with the values 0 and 1.

Recall and saving of a preset position can be executed with a single push button. For example, a position is recalled with a short button push and the current position is saved as the new preset position with a long button push.

- *Yes*: The communication objects *Move to position 1, 2*, *Move to position 3, 4*, *Set position 1, 2* and *Set position 3, 4* are enabled. The following parameters also appear:

Overwrite position values (presets) during download

Options: Yes
 No

- *Yes*: The preset positions are overwritten on downloading with the settings in the application.
- *No*: The preset positions previously saved (see above) remain intact on redownloading the application and are not overwritten with the preset values.

Note
If individual preset values have been set during current operation by a user, the parameter should then be set to <i>No</i> to ensure that the individual positions are retained!

Position 1: Height in % [0...100]
(0% = top; 100% = bottom)

Position 2: Height in % [0...100]
(0% = top; 100% = bottom)

Position 3: Height in % [0...100]
(0% = top; 100% = bottom)

Position 4: Height in % [0...100]
(0% = top; 100% = bottom)

Options: 0..20..40..60..80..100

These parameters specify the blind/shutter heights for traveling to a preset position.

Position 1: Slat in % [0...100]
(0% = open; 100% = closed)

Position 2: Slat in % [0...100]
(0% = open; 100% = closed)

Position 3: Slat in % [0...100]
(0% = open; 100% = closed)

Position 4: Slat in % [0...100]
(0% = open; 100% = closed)

Note
The parameters for slat adjustment are available exclusively in the operation mode <i>Control with slat adjustment</i> .

Options: 0...20...40...60...80...100

These parameters specify the slat settings for traveling to a preset position.

Move to position

Options: Directly
Indirectly via upper end position
Indirectly via lower end position
Indirectly via shortest way

- *Directly*: The blind/shutter moves from the current position directly to the new target position.
- *Indirectly via upper or lower end position*: The blind/shutter firstly moves to the very top or the very bottom and only then to the target position.
- *Indirectly via shortest path*: The blind/shutter firstly moves to the very top or very bottom, depending on which of the two paths is the shorter between the current position and the target position, and then moves to the target position.

3.2.5.4.2 Parameter window A: Automatic Sun Protection

In this parameter window, all the settings for the automatic sun protection are undertaken.

General	Deactivation of automatic control	Via object "Activation" and move command
Manual operation	Automatic reactivation of automatic control	Deactivated
Weather alarms	Toggling to automatic control	Enabled
A: General	Toggling to direct control	Enabled
A: Safety/Weather	Position for sun = 1 (sun)	Down
A: Drive	Position for sun = 0 (no sun)	Up
A: Blinds/Shutter	Delay for sun = 1 in s [0...6,000]	0
A: Functions	Delay for sun = 0 in s [0...6,000]	0
A: Automatic Sun Protection	Read activated automatic objects after bus voltage recovery	No
A: Status messages	Enable heating/cooling automatic	No
B: General		
B: Safety/Weather		
B: Drive		
B: Blinds/Shutter		
B: Functions		
B: Status messages		
C: General		
C: Safety/Weather		
C: Drive		

Together with other KNX components (in particular with the Shutter Control Unit JSB/S), the blind and roller shutter actuator can be used to establish easy-to-use automatic sun protection control. Automatic control can be activated individually for each output.

For more information on the function Automatic Sun Protection, see the application manual [Shutter control](#)

Note

These are direct communication objects:

- Move blinds/shutter up-down
- Slat adjustment/Stop up-down
- Blinds/shutter up-down limited
- Move to position [0...255]
- Move slat [0...255]
- Move to position 1, 2
- Move to position 3, 4
- Scene

If travel detection or a reference movement is triggered during active automatic control, it will be undertaken.

Deactivation of automatic control

Options: Via object "Activation"
Via object "Activation" and move command

- *Via object "Activation"*: The automatic control is activated = 1 and deactivated = 0 exclusively by a telegram to the communication object *Activation of autom. control*. If automatic control is activated, the incoming telegrams to the direct communication objects are not executed. After deactivation of automatic control, the blind/shutter remains in its current position and can be controlled again via the direct communication objects.
- *Via object "Activation" and move command*: Incoming telegrams to direct communication objects also lead to deactivation of automatic control. The following parameter appears:

Automatic reactivation of automatic control

Options: Deactivated
Activated

If automatic control was deactivated via one of the direct communication objects, it is possible to reactivate automatic control automatically after a parameterized time.

- *Activated*: The following parameter appears.

Time to reactivate autom. control automatically in min. [10...6,000]

Options: 10...300...6.000

Note
A change of the parameter value will only become active after the next deactivation of automatic control by a direct communication object.

Toggleing to automatic control

Toggleing to direct control

Options: Enabled
Disable/enable via object

This parameter determines how the switchover to automatic control or direct control is enabled or whether it should be enabled/disabled via an additional communication object.

- *Disable/enable via object*: The communication objects *Disable/enable autom. control* and *Disable/enable direct control* are enabled.

Position for sun = 1 (sun)

Position for sun = 0 (no sun)

Options: No reaction
Up
Down
Stop
Position 1-4
Individual position
Receive position via object
Receive height and slat via object¹
Receive only slat via object¹
Receive position via object²
Deactivated

¹ Only in the operation mode Control with slat adjustment

² Only in the operation mode Control without slat adjustment

These parameters are used to set the reaction for the communication object Sun = 1 (sun) or for the communication object 0 (no sun) in automatic operation.

- *No reaction:* Any movement currently being undertaken is completed.
- *Up or Down:* The blind/shutter moves up or down.
- *Stop:* Any movement currently being undertaken by the blind/shutter is stopped immediately. The outputs are disconnected from the voltage supply.
- *Position 1-4:* If one of these positions are selected, the blind/shutter moves to a preset position. The blind/shutter height and slat setting of the corresponding position can be set in parameter window A: *Positions/Presets*, p. 72.
- *Individual position:* A freely-definable position is set on Sun = 1 or 0. The following parameters appear:

Position height in %
(0% = top; 100% = bottom)

Position Slat in % [0...100]
(0% = open; 100% = closed)

Note
The parameters for slat adjustment are available exclusively in the operation mode <i>Control with slat adjustment</i> .

The parameters for slat adjustment are available exclusively in the operation mode *Control with slat adjustment*.

These parameters specify the height or the slat position of the blind/shutter.

Options: 0...100

- *Receive position and slat via object:* This option is suitable particularly in conjunction with the Shutter Control Unit JSB/S.

Note
This parameter is available exclusively in the operation mode <i>Control with slat adjustment</i> .

This parameter is available exclusively in the operation mode *Control with slat adjustment*.

- *Receive only slat via object:* With activated automatic function and Sun = 1, only the value on the communication object *Adjust slat for sun [0...255]* is evaluated.

Note
This parameter is available exclusively in the operation mode <i>Control with slat adjustment</i> .

This parameter is available exclusively in the operation mode *Control with slat adjustment*.

Note
A slat adjustment is not carried out if the blind/shutter is in its upper end position.

A slat adjustment is not carried out if the blind/shutter is in its upper end position.

- *Receive position via object:* The position of the blind/shutter is received via the communication object *Adjust slat for sun [0...255]*.

Note
This parameter is available exclusively in the operation mode <i>Control without slat adjustment</i> .

This parameter is available exclusively in the operation mode *Control without slat adjustment*.

Delay for sun = 1
in s [0...6,000]

Delay for sun = 0
in s [0...6,000]

Options: 0...6,000

This parameter defines the reaction to the communication object *Sun*.

Note

If, in the parameter window General, a time has been entered in the parameter Time-delayed switching of drives, this time must be added to the delay times for Sun = 1 or 0.
The delay times can also be set in the brightness sensor and in the Shutter Control Unit. It must be noted that the delay times can add up in this way.

Read activated automatic objects after bus voltage recovery

Options: Yes
 No

- Yes: After bus voltage recovery, the values required for automatic control can be read out via the KNX. This updates the values of the communication objects.

Note

The Read flags must be set on the communication objects to be read.

Enable automatic heating/cooling

Options: Yes
 No

This parameter enables the automatic HEATING/COOLING control.

- Yes: The communication objects *Heating*, *Cooling*, *Presence* and *Receive room temperature* are enabled. The following parameters appear.

Delay for presence = 1 in s [0...6,000]

Delay for presence = 0 in s [0...6,000]

Options: 0...6,000

Automatic heating / cooling is an extension of sun protection control and can only be activated together with automatic control. Automatic sun protection and automatic heating/cooling is toggled via the communication object *Presence*, e.g. via a presence detector.

To prevent the blind/shutter from continuously moving up and down as soon as a person enters or leaves the room, the reaction of the communication object *Presence* can be delayed. Thus the blind/shutter moves, for example, to the sun protection position when the room is entered and automatic HEATING/COOLING is only activated after a delay when the room is left.

Position for heating = 1 and sun = 1

Position for heating = 1 and sun = 0

Position for cooling = 1 and sun = 1

Position for cooling = 1 and sun = 0

Options: No reaction
 Up
 Down
 Stop
 Position 1...4
 Individual position

This parameter sets the response for Sun = 1 (sun) or for Sun = 0 (no sun) during the heating/cooling phase.

The phases HEATING = 1 or COOLING = 1 can, for example, be triggered by an external temperature sensor, room thermostat or by a yearly clock timer.

If both the HEATING and COOLING operations are activated simultaneously or neither operation mode is activated, this is an undefined operating condition. The blind/shutter is automatically controlled until then using automatic sun protection.

Note

If the system should only use automatic heating/cooling, the communication object *Presence* may not be linked to a group address. This means that the communication object automatically has the default value 0. Automatic heating/cooling is immediately activated when automatic control is activated via the communication object *Activation of autom. control*.

- *No reaction*: If the blind/shutter is performing a movement, this movement to the target position is carried out. If the blind/shutter is at rest, it will remain unchanged in its position.
- *Up*: The blind/shutter moves up.
- *Down*: The blind/shutter moves down.
- *Stop*: Any movement currently being undertaken by the blind/shutter is stopped immediately. The outputs are disconnected from the voltage supply.
- *Position 1...4*: If one of these positions are selected, the blind/shutter moves to a preset position. The blind/shutter height and slat setting of the corresponding position can be set in parameter window A: *Positions/Presets*, p. 72.
- *Individual position*: A freely definable position is set for Sun = 1. The following parameters appear:

Position height in %
(0% = top; 100% = bottom)

Position Slat in % [0...100]
(0% = open; 100% = closed)

Note

The parameters for slat adjustment are available exclusively in the operation mode *Control with slat adjustment*.

Options: 0...100

These parameters specify the height or the slat position of the blind/shutter.

Use overheat control

Options: Yes
No

Overheat control prevents the heating up of a room during an absence. During the heating period, rooms with large glass windows can heat up quickly in strong sunlight, even if the external temperature is low. Overheat control is used to prevent this and save possible cooling energy.

- Yes: The communication object *Receive room temperature* and the following parameters appear:

Upper threshold value room temperature in °C [21...50]

Options: 21...24...50

If the temperature value set here is reached or exceeded, then the blind/shutter moves to a parameterizable position, e.g. DOWN. If the temperature value is undershot by minus 3 Kelvin, then overheat control is terminated. The blind/shutter is then moved to the parameterized position, according to the values of the communication objects *Heating* and *Sun*.

Position at upper threshold value and sun = 1

Options: Down
Position 1...4
Individual position

The blind/shutter moves to the position input here as soon as the specified threshold value has been exceeded.

- *Down*: If the upper room temperature threshold value is exceeded or if Sun = 1, the blind/shutter will move down.
- *Position 1...4*: If the upper room temperature threshold value is exceeded or if Sun = 1, the blind/shutter will move to the position which can be set in the parameter window *A: Positions/presets*, p. 72.
- *Individual position*: A freely definable position can be set for when the upper room temperature threshold value is exceeded or for when Sun = 1. The following parameters appear:

Position height in % [0...100]
(0% = top; 100% = bottom)

Position slat in % [0...100]
(0% = open; 100% = closed)

Options: 0...100

These parameters specify the height or the slat position of the blind/shutter.

Important

If HEATING/COOLING = 1 or HEATING/COOLING = 0 (undefined operating condition), then the output is only controlled by the automatic sun protection.

3.2.5.4.3 Parameter window A: Scene

In this parameter window, all settings for the 8 bit scene are undertaken. Each output can be allocated to up to 18 different scenes

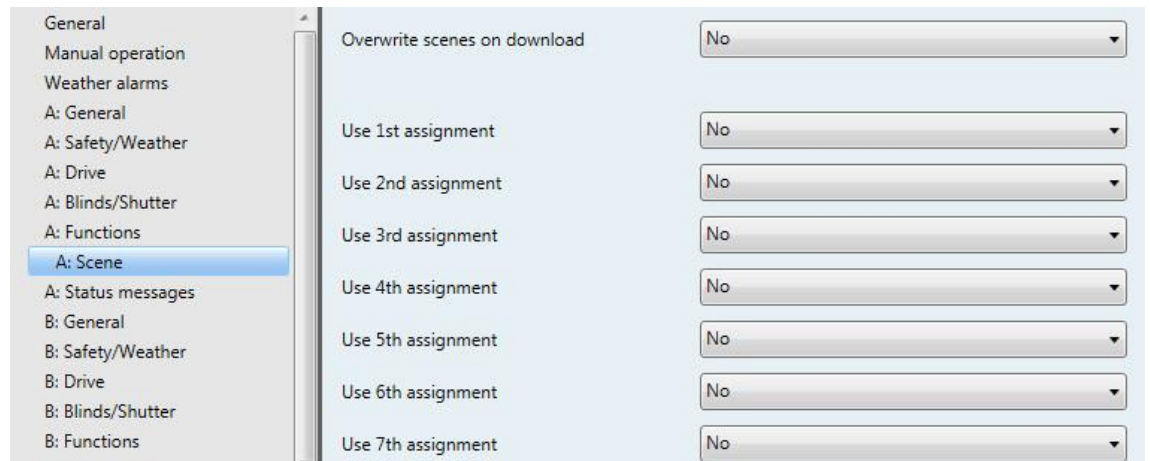

Overwrite scenes on download

Options: Yes
No

This parameter specifies the reaction of the set scenes to a download.

- Yes: During a download, the scenes are overwritten with the parameterized scene values.
- No: The parameterized scene values are not applied during a download.

Use 1st assignment

...

Use 18th assignment

Options: Yes
No

With the scene function, up to 64 different scenes are managed via a single group address. With this group address, all the devices integrated into a scene are linked via a 1-byte communication object. The following information is contained in a telegram:

- Number of the scene (1...64)
- Telegram: *Recall scene* or *Save scene*

Each blind/shutter can be integrated in up to 18 scenes. Thus, for example, all the roller shutters can be raised in the morning via a scene and lowered in the evenings or blinds/shutters can be integrated into lighting scenes.

If a telegram is received at the communication object *Scene*, then the saved scene position is moved to by all the outputs assigned to the sent scene number, or the current position saved as the new scene position.

- Yes: The following parameters appear.

Assignment to scene number 1...64

Options: Scene No. 1...Scene No. 64

In this parameter, the output is assigned to a scene number (1...64). As soon as the device a telegram with this scene number at the communication object *8 bit scene* (No. x), it will recall the corresponding scene.

- *Scene No. A*: This parameter assigns the output to a scene number

Position height in % [0...100]

(0% = top; 100% = bottom)

Position Slat in % [0...100]

(0% = open; 100% = closed)

Note
The parameters for slat adjustment are available exclusively in the operation mode <i>Control with slat adjustment</i> .

Options: 0...100

These parameters specify the height or the slat position to which the blind/shutter should move when the appropriate scene is recalled.

3.2.5.5 Parameter window A: Status messages

Settings for the status messages and their send reaction are undertaken in this parameter window.

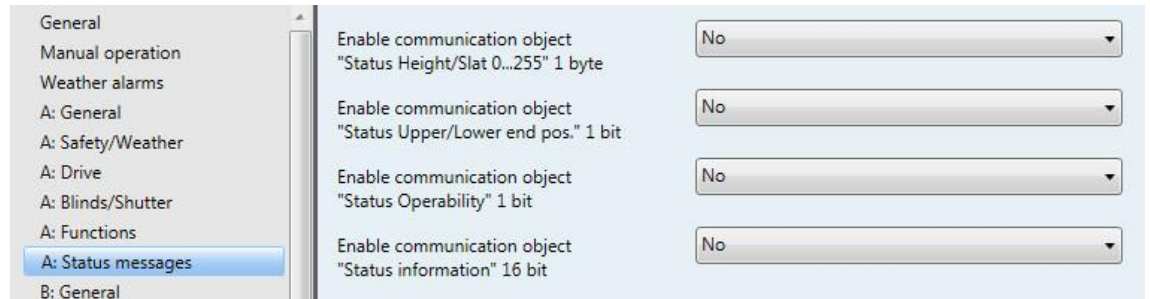

Enable communication object "Status Height/slat [0...255]" 1 byte

Options: Yes
 No

The output sends the relative position of the blind/shutter and the slat position to two separate communication objects, each as a 1-byte value (0...255). The following applies to the position of the blind/shutter: The value 0 corresponds to the top position (0 %). The value 255 corresponds to the bottom position (100 %).

The following applies to the slat position: The value 0 corresponds to the open slat position (0 %). The value 255 corresponds to the slat position closed (100 %).

- Yes: The communication objects *Status Height [0...255]* and *Status Slat [0...255]* (only in the operation mode *Control with slat adjustment*) are enabled. The following parameter appears:

Send object value

Options: No, update only
 On change
 On request
 On change or on request

- *No, only update*: The status is updated but not sent (the status can be read via the communication object).
- *On change*: The status is sent when a change occurs.
- *On request*: The status is sent when a request occurs.
- *On change or on request*: The status is sent on a change or a request.

Enable communication object "Status Upper/Lower end pos." 1 bit

Options: Yes
 No

The output sends the information as to whether the blind/shutter is in the upper or lower end position to two separate communication objects. If the information is sent to both communication objects stating that the respective end position has not been reached, the the blind/shutter is in an intermediate position.

This function is particularly suitable for an additional logic operation, in order to mutually interlock individual outputs. For example, an awning may not move if the window is opened and, in turn, the window may also not be opened by a drive if the awning is extended.

- Yes: The communication objects *Status Upper end position* and *Status Lower end position* are enabled. The following parameter appears:

Send object value

Options: No, update only
 On change
 On request
 On change or on request

- *No, only update*: The status is updated but not sent (the status can be read via the communication object).
- *On change*: The status is sent when a change occurs.
- *On request*: The status is sent when a request occurs.
- *On change or on request*: The status is sent on a change or a request.

Enable communication object "Status Operability" 1 bit

Options: Yes
 No

This function is particularly suitable to indicate to the user via an LED on the push button that the blind/shutter cannot currently be operated via the direct communication objects (e.g. UP, DOWN...) and that automatic control cannot be activated.

Operation is blocked if

- a safety function was activated, e.g. Weather alarm, Disable or Forced operation
 - manual operation is active
 - direct and automatic operation are disabled via communication objects
- Yes: The communication object *Status Operability* is enabled. The following parameter appears:

Send object value

Options: No, update only
 On change
 On request
 On change or on request

- *No, only update*: The status is updated but not sent (the status can be read via the communication object).
- *On change*: The status is sent when a change occurs.
- *On request*: The status is sent when a request occurs.
- *On change or on request*: The status is sent on a change or a request.

Enable communication object "Status Automatic" 1 bit

Options: Yes
 No

The output sends information on whether automatic control is activated or deactivated (1 bit).

This function is particularly suitable to indicate to the user via an LED if automatic control has been activated.

- **Yes**: The communication object *Status Automatic* is enabled. The following parameter appears:

Send object value

Options: No, update only
 On change
 On request
 On change or on request

- *No, only update*: The status is updated but not sent (the status can be read via the communication object).
- *On change*: The status is sent when a change occurs.
- *On request*: The status is sent when a request occurs.
- *On change or on request*: The status is sent on a change or a request.

Enable communication object "Status information" 16 bit

Options: Yes
 No

This parameter enables a 16-bit communication object, which can be used to read out, send or poll additional status information.

- Yes: The communication object *Status information* is enabled. The following parameter appears:

Send object value

Options: No, update only
 On change
 On request
 On change or on request

- *No, only update*: The status is updated but not sent (the status can be read via the communication object).
- *On change*: The status is sent when a change occurs.
- *On request*: The status is sent when a request occurs.
- *On change or on request*: The status is sent on a change or a request.

3.2.6

Parameter *Operation mode: Ventilation flaps, switch mode*

General	Operation mode	Ventilation flaps, switch mode
Manual operation	Reaction on bus voltage failure/recovery programming and reset	
Weather alarms	Reaction on bus voltage failure	Open/on
A: General	Reaction after bus voltage recovery	Open/on
A: Safety/Weather	Reaction after programming or after ETS reset	Open/on
A: Status messages	Invert output	No
B: General	Staircase lighting function	Deactivated
B: Safety/Weather		
B: Drive		
B: Blinds/Shutter		
B: Functions		
B: Status messages		
C: General		
C: Safety/Weather		
C: Drive		

Operation mode

Options: Control with slat adjustment
Control without slat adjustment
Ventilation flaps, switch mode

This parameter defines the operating mode of the output. The communication objects and the parameters for the respective outputs differ slightly depending on the operation mode. You can find the description of the operation modes *Control with slat adjustment* and *Control without slat adjustment* from p. 50 onwards.

Note

In the operation mode *Ventilation flaps, switch mode*, there is a fixed pause on changing direction of 100 ms on each output for switch operations.
Observe the technical data of the drive manufacturer!

- *Ventilation flaps, switch mode*: The following parameters appear:

Reaction on bus voltage failure

Reaction after bus voltage recovery

Reaction after programming or after ETS reset

Options: No reaction
Open/on
Close/off

These parameters determine the response to a bus voltage failure, bus voltage recovery or after a download and ETS reset.

- *No reaction*: The output contacts remain in their current position.
- *Open/on*: The output contact (terminal 1, 3, 6, 8 or 11, 13, 16, 18) closes. The ventilation flap is opened and connected consumers switched on.

Note

If there is a bus voltage failure, the output remains switched on, even if the function *Staircase lighting* is activated.

After bus voltage recovery and during an active Staircase lighting function, the output switches off after the parameterized duration or opening time has elapsed.

- *Closed/off*: The output contact (terminal 1, 3, 6, 8 or 11, 13, 16, 18) opens (neutral middle position). The ventilation flap is closed and connected consumers switched off.

Invert output

Options: Yes
 No

This parameter inverts the reaction of the output.

- *Yes*: If a telegram with the value 1 is received at the communication object *Flaps open-closed/on-off*, then the ventilation flap is closed or the consumer is switched off. If a telegram with the value 0 is received, then the ventilation flap is opened or the consumer is switched on. In addition, all the settings made for the output, e.g. OPEN/ON or CLOSED/OFF are inverted for weather alarms, bus voltage recovery, etc.

Staircase lighting function

Options: Deactivated
 Activated

This parameter enables the function *Staircase lighting*.

- *Activated*: The following parameter appears.

Duration/opening time for staircase lighting function in s [0...30,000]

Options: 0...60...30,000

This parameter specifies the duration or opening time of the staircase lighting.

3.2.6.1 Parameter window A: Safety/weather

In this parameter window, the settings affecting the function *Safety/weather* are undertaken.

Parameter	Setting
Parameter settings	Standard
Output reacts on communication object for wind alarm no.	1
Position on wind alarm	Activated - open/on
Position on rain alarm	Deactivated
Position for frost alarm	Deactivated
Block	Deactivated
Forced operation (1 bit/2 bit)	Deactivated
Position on reset of weather alarm, blocking and forced operation	Open/on
Order of priority for safety alarm functions	1.Weather alarm - 2.Block - 3.Forced operation
Wind, rain, and frost alarm are active if objects on page "Weather alarms" are enabled and linked with group addresses	
<-- Note	

Parameter settings

Options: Standard
User-defined

This parameter defines the scope of parameterization.

- *Standard*: In the case of a wind alarm, the blind/shutter moves to a preset position using the parameter *Position on wind alarm*. This setting is usually sufficient in smaller projects. In this setting, the output only reacts to the communication object *Wind alarm No. 1*.
- *User-defined*: Complete parameter access for complex applications or safety settings of the output are possible. Other parameters appear.

Output reacts on communication object for wind alarm no.

Options: Output does not react to wind alarm
1/ 2/ 3/ 1+2/ 1+3/ 2+3/ 1+2+3

This parameter determines the Wind alarm communication objects to which the output reacts. The values of the assigned communication objects are linked by a logic OR.

Position on wind alarm

Position on rain alarm

Position on frost alarm

Options: Activated - no reaction
 Activated - open/on
 Activated - close/off
 Deactivated

These parameters define the position of the output when a weather alarm (wind, rain, frost) is received. The output can no longer be operated via other communication objects or by manual operation until the weather alarm has been rescinded.

- *Activated - no reaction*: If the output is currently performing a movement, this action is terminated. If the output is at rest, it will remain unchanged in its position.
- *Activated- open/on*: The output contact is activated. The ventilation flap opens or the consumer is switched on.
- *Activated - closed/off*: The output contact is disconnected from the voltage supply. The ventilation flap closes or the consumer is switched off.
- *Deactivated*: The output does not react to an alarm, nor to the monitoring time. No setting can be made for a weather alarm.

Block

Options: Deactivated
 Activated

This parameter enables the function *Block*. The output moves, e.g. to a parameterized position, or operation is disabled.

- *Activated*: The communication object *Block* is enabled. The following parameter appears.

Position during blocking

Options: No reaction
 Open/on
 Close/off

This parameter specifies the reaction of the output for the function *Block*.

- *No reaction*: If the output is performing a movement, this movement action to the target position is carried out. If the blind/shutter is at rest, it will remain unchanged in its position.
- *Open/on*: The output contact is activated. The ventilation flap opens or the consumer is switched on.
- *Closed/off*: The output contact is disconnected from the voltage supply. The ventilation flap closes or the consumer is switched off.

Forced operation

Options: Deactivated
 Activated (1 bit)
 Activated (2 bit)

With the Forced operation function, the output can be moved in a specific direction via a 1-bit telegram or be opened/closed or switched on/off via 2-bit telegrams and the operation can be disabled.

- **Activated (1 bit):** The communication object *Forced operation 1 bit* is enabled. The following parameter appears:

Position during forced operation

Options: No reaction
 Open/on
 Close/off

The reaction on Forced operation is set here.

- *No reaction:* If the output is currently execution a movement telegram, this action is terminated. If the output is at rest, it will remain unchanged in its position.
 - *Open/on:* The output contact is activated. The ventilation flap opens or the consumer is switched on.
 - *Closed/off:* The output contact is disconnected from the voltage supply. The ventilation flap closes or the consumer is switched off.
- *Activated (2 bit):* The communication object *Forced operation 2 bit* is enabled.

Position on reset of weather alarm, blocking and forced operation

Options: No reaction
 Open/on
 Close/off

This parameter determines the reaction when rescinding a weather alarm, block or a forced operation.

- *No reaction:* If the output is currently execution a movement telegram, this action is terminated. If the output is at rest, it will remain unchanged in its position. If, during a Weather alarm, Block or Forced operation, the output was parameterized or switched with Open/on, the the staircase lighting time is restarted after the rescinding of a safety telegram (e.g. Wind alarm).
- *Open/on:* The output contact is activated. The ventilation flap opens or the consumer is switched on.
- *Closed/off:* The output contact is disconnected from the voltage supply. The ventilation flap closes or the consumer is switched off.

Order of priority for safety alarm functions

- Options:
- 1. Weather alarm - 2. Block - 3. Forced operation
 - 1. Weather alarm - 2. Forced operation - 3. Block
 - 1. Block - 2. Weather alarm - 3. Forced operation
 - 1. Block - 2. Forced operation - 3. Weather alarm
 - 1. Forced operation - 2. Block - 3. Weather alarm
 - 1. Forced operation - 2. Weather alarm - 3. Block

This parameter determines the sequence of priorities for the safety functions Weather alarms (wind, rain, frost), Block and Forced operation. These functions have a higher priority than all other functions. If one of these functions is activated, the operation of the output is disabled. This also applies during manual operation.

A priority must also be defined for safety functions among one another. In this way, the output is correctly controlled if more than one security function is activated simultaneously.

Note
Wind, rain and frost alarm are only activated if, on the page <i>Weather alarms</i> , the communication objects are enabled and linked to the group addresses!

3.2.6.2 Parameter window A: Status messages

Settings for the status messages and their send reaction are undertaken in this parameter window.

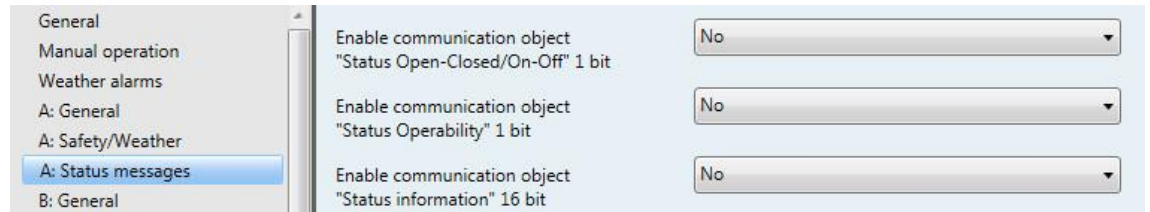

Enable communication object "Status Open-Closed/On-Off" 1 bit

Options: Yes
No

- Yes: The communication object *Status Open-Closed/On-Off* is enabled. The following parameter appears:

Send object value

Options: No, update only
On change
On request
On change or on request

- *No, only update*: The status is updated but not sent (the status can be read via the communication object).
- *On change*: The status is sent when a change occurs.
- *On request*: The status is sent when a request occurs.
- *On change or on request*: The status is sent on a change or a request.

Enable communication object "Status Operability" 1 bit

Options: Yes
No

This function is particularly suitable to indicate to the user via an LED that the output cannot currently be operated via the direct communication objects (e.g. UP, DOWN...).

Operation is blocked if

- a safety function was activated, e.g. Weather alarm, Disable or Forced operation
- manual operation is active
- Yes: The communication object *Status Operability* is enabled. The following parameter appears:

Send object value

Options: No, update only
 On change
 On request
 On change or on request

- *No, only update*: The status is updated but not sent (the status can be read via the communication object).
- *On change*: The status is sent when a change occurs.
- *On request*: The status is sent when a request occurs.
- *On change or on request*: The status is sent on a change or a request.

Enable communication object "Status information" 16 bit

Options: Yes
 No

This parameter enables a 16-bit communication object, which can be used to read out, send or poll additional status information.

- Yes: The communication object *Status information* is enabled. The following parameter appears:

Send object value

Options: No, update only
 On change
 On request
 On change or on request

- *No, only update*: The status is updated but not sent (the status can be read via the communication object).
- *On change*: The status is sent when a change occurs.
- *On request*: The status is sent when a request occurs.
- *On change or on request*: The status is sent on a change or a request.

3.3 Communication objects

The functions of the JRA/S x.y.5.1 Blind / Roller Shutter Actuator with Travel Detection and Manual Operation are explained using the operation mode *Control with slat adjustment*. The device types JRA/S x.y.2.1 and JRA/S x.y.1.1 do not possess some parameters or the corresponding communication objects.

- JRA/S x.y.2.1 does not possess a travel detection function
- JRA/S x.y.1.1 does not possess manual operation nor a travel detection function

The parameters as well as the communication objects, which are not available or are exclusively available in the operation mode *Control without slat adjustment*, are specially marked.

Note
The device possesses several outputs. However, as the functions for all outputs are identical, only the functions of output A will be described.

3.3.1 Summary of communication objects

CO No.	Function	Name	Data Point Type (DPT)	Length	Flags				
					C	R	W	T	U
0	In operation	General	DPT 1.002	1 bit	x	x		x	
1	Request status values	General	DPT 1.017	1 bit	x		x		
2	Disable/enable man. operation	General	DPT 1.003	1 bit	x		x		
3	Status Man. operation	General	DPT 1.002	1 bit	x	x		x	
4	Wind alarm no. 1	Output A-X	DPT 1.005	1 bit	x		x	x	x
5	Wind alarm no. 2	Output A-X	DPT 1.005	1 bit	x		x	x	x
6	Wind alarm no. 3	Output A-X	DPT 1.005	1 bit	x		x	x	x
7	Rain alarm	Output A-X	DPT 1.005	1 bit	x		x	x	x
8	Frost alarm	Output A-X	DPT 1.005	1 bit	x		x	x	x
9	Not assigned								
10	Move blinds/shutter up-down	Output A	DPT 1.008	1 bit	x		x		
11	Slat adjustm./stop up-down	Output A	DPT 1.007	1 bit	x		x		
12	Blinds/shutter up-down limited Enable limitation	Output A	DPT 1.008 DPT 1.003	1 bit	x		x		
13	Move to pos. height [0...255]	Output A	DPT 5.001	1 byte	x		x		
14	Move slats [0...255]	Output A	DPT 5.001	1 byte	x		x		
15	Move to position 1, 2	Output A	DPT 1.022	1 bit	x		x		
16	Move to position 3, 4	Output A	DPT 1.022	1 bit	x		x		
17	Set position 1, 2	Output A	DPT 1.022	1 bit	x		x		
18	Set position 3, 4	Output A	DPT 1.022	1 bit	x		x		
19	Trigger travel detection Trigger reference movement	Output A	DPT 1.003 DPT 1.008	1 bit	x		x		





ABB i-bus[®] KNX Start-up

CO No.	Function	Name	Data Point Type (DPT)	Length	Flags				
					C	R	W	T	U
20	8-bit scene	Output A	DPT 18.001	1 byte	x		x		
21	Activation of autom. control	Output A	DPT 1.003	1 bit	x		x	x	x
22	Sun	Output A	DPT 1.002	1 bit	x		x	x	x
23	Move to height for sun [0...255]	Output A	DPT 5.001	1 byte	x		x	x	x
24	Adjust slat for sun [0...255]	Output A	DPT 5.001	1 byte	x		x	x	x
25	Presence	Output A	DPT 1.002	1 bit	x		x	x	x
26	Heating	Output A	DPT 1.002	1 bit	x		x	x	x
27	Cooling	Output A	DPT 1.002	1 bit	x		x	x	x
28	Receive room temperature	Output A	DPT 9.001	2 byte	x		x	x	x
29	Disable/enable autom. control	Output A	DPT 1.003	1 bit	x		x	x	x
30	Disable/enable direct control	Output A	DPT 1.003	1 bit	x		x	x	X
31	Disable	Output A	DPT 1.003	1 bit	x		x	x	x
32	Forced operation (1 bit)	Output A	DPT 1.003	1 bit	x		x	x	x
	Forced operation (2 bit)		DPT 2.002	2 bit	x		x		
33	Status Height [0...255]	Output A	DPT 5.001	1 byte	x	x		x	
34	Status Slat [0...255]	Output A	DPT 5.001	1 byte	x	x		x	
35	Status Upper end position	Output A	DPT 1.011	1 bit	x	x		x	
36	Status Lower end position	Output A	DPT 1.011	1 bit	x	x		x	
37	Status Operability	Output A	DPT 1.011	1 bit	x	x		x	
38	Status Automatic	Output A	DPT 1.011	1 bit	x	x		x	
39	Status information	Output A	Non DPT	2 byte	x	x		x	

* CO = communication object

3.3.2 Communication objects *General*

These communication objects are only available once per device for all operation modes and serve the interdisciplinary functions.

No.	Function	Object name	Data type	Flags
0	In operation	General	1 bit DPT 1.002	C, R, T
<p>The communication object is enabled if the parameter <i>Send communication object "In operation"</i> in the <i>General</i> parameter window was selected as <i>Yes</i>.</p> <p>In order to monitor the operation of the blind/roller shutter actuator at regular intervals, an In operation telegram can be sent cyclically to the bus.</p> <p>As long as the communication object is activated, it sends a parameterizable In operation telegram.</p>				
1	Request status values	General	1 bit DPT 1.017	C, W
<p>If a telegram with the value x (x = 0/1/0 or 1) is received at this communication object, all the status objects are sent to the bus, as long as they were not programmed with the option <i>On change or request</i>.</p> <p>Option x = 1 produces the following function:</p> <p>Telegram value: 1 = All status messages, provided they are programmed with the option <i>On change or request</i>, are sent. 0 = No reaction.</p>				
2	Disable/enable man. operation	General	1 bit DPT 1.003	C, W
<p>Using this communication object, <i>Manual operation</i> is disabled or enabled.</p> <p>Using the value 0, the button  is enabled on the device.</p> <p>Using the value 1, the button  is disabled on the device.</p> <p>Telegram value: 0 = Button  enabled 1 = Button  disabled</p>				
3	Status Man. operation	General	1-byte DPT 1.011	C, R, T
<p>This communication object indicates whether manual operation is activated.</p> <p>Telegram value: 0 = Manual operation not active 1 = Manual operation active</p> <p>The status of manual operation is sent, depending on parameterization, <i>On change</i>, <i>On request</i> and <i>On change or request</i>.</p>				

No.	Function	Object name	Data type	Flags
4	Wind alarm no. 1	Output A...X	1 bit DPT 1.005	C, R, T, U
5	Wind alarm no. 2			
6	Wind alarm no. 3			
7	Rain alarm			
8	Frost alarm			
<p>These communication objects can be monitored cyclically. The interval is determined by the monitoring time. If a telegram with the value 0 is received within the monitoring time, then operation of the blinds/shutters is enabled.</p> <p>If a telegram with the value 1 is received or no telegram is received during the monitoring period, then the blinds/shutters are moved to the parameterized <i>Position on wind alarm</i> (or <i>Rain alarm</i> or <i>Frost alarm</i>). Operation via direct telegrams and automatic telegrams is disabled.</p> <p>The first time a telegram with the value 0 is received again after a weather alarm or after the monitoring period has been exceeded, the blinds/shutters are moved to the parameterizable <i>Position on reset of weather alarm</i> and operation is enabled again.</p> <p>The monitoring period is restarted after each telegram is received as well as after programming of the actuator and on bus voltage recovery. The three wWind alarm communication objects are logically connected via an OR gate, i.e. if a wind alarm is present for one of the three communication objects or a telegram is not received within the monitoring period, the blind/shutter moves to the parameterized <i>Position on wind alarm</i>.</p> <p>Telegram value: 0 = No alarm 1 = Alarm (operation disabled)</p>				
9	Not assigned			

3.3.3 Communication objects, output A...X *Control with and without slat adjustment*

These communication objects are available to each output and are used for channel-specific functions. The following section describes the communication objects for the operation modes *Control with slat adjustment* and *Control without slat adjustment*.

No.	Function	Object name	Data type	Flags
10	Move blinds/shutter up-down	Output	1 bit DPT 1.008	C, W
<p>If a telegram with the value 0 is received at this communication object, the blind/shutter is moved upwards to the rest position or to the upper end position. If a telegram with the value 1 is received, the blind/shutter is moved downwards.</p> <p>Telegram value 0 = UP 1 = DOWN</p>				
11	Slat adjustm./stop up-down¹ Stop Up-Down²	Output A	1 bit DPT 1.007	C, W
<p>When a telegram is received (irrespective of whether the value is 0 or 1) at this communication object, the movement is stopped.</p> <p>¹ Operation mode <i>Control with slat adjustment</i>: When the blind/shutter is at rest and a telegram is received at this communication object, a slat adjustment upwards (0 = OPEN) or downwards (1 = CLOSE) is carried out.</p> <p>² Operation mode <i>Control without slat adjustment</i>: When the blind/shutter is at rest and a telegram is received, no action is undertaken.</p> <p>Telegram value 0 = STOP/open slat adjustment 1 = STOP/slat adjustment close</p>				
12	Blinds/shutter up-down limited	Output A	1 bit DPT 1.008	C, W
<p>This communication object is enabled if in the parameter window <i>Blinds/shutter</i>, page 63, the option <i>Via object "Blinds/shutter up-down limited"</i> was selected under the parameter <i>Limit traveling range</i>. If a telegram with the value 0 is received at this communication object, the blind/shutter will move upwards to the parameterized limit. If a telegram with the value 1 is received, the blind/shutter will move downwards to the parameterized limit. The blind/shutter is stopped automatically if the parameterized upper or lower limit is reached.</p> <p>Telegram value 0 = Limited UP 1 = Limited DOWN</p>				
12	Enable limitation	Output A	1 bit DPT 1.003	C, W
<p>This communication object is enabled if, in the parameter window <i>Blinds/shutter</i>, page 63, the option <i>Via object "Enable limitation"</i> was selected under the parameter <i>Limit travelling range</i>. The parameters can be used to set whether the limitation should be executed for a direct telegram or an automatic telegram.</p> <p>Telegram value: 0 = Limitation inactive 1 = Limitation active</p>				

No.	Function	Object name	Data type	Flags		
13	Move to pos. height [0...255]	Output A	1-byte DPT 5.001	C, W		
<p>This communication object is enabled if, in the parameter window <i>A: Positions/presets</i>, p.72, the parameter <i>Enable communication objects "Move to height/slat position [0...255]"</i> was selected with option <i>Yes</i>.</p> <p>If a telegram is received at this communication object, the blind/shutter is moved to the height corresponding to the received value.</p> <p>After the target position is reached, the slats will assume the same position which they had before the movement started. If a telegram is received during movement at the communication object <i>Move slats [0...255]</i>, then the slat are set according to the received value after the target position has been reached.</p> <p>Telegram value: 0 = Upper ... = Intermediate position 255 = Lower</p>						
14	Move slats [0...255]	Output A	1-byte DPT 5.001	C, W		
<p>This communication object is enabled if, in the parameter window <i>A: Positions/presets</i>, p.72, the parameter <i>Enable communication objects "Move to height/slat position [0...255]"</i> was selected with option <i>Yes</i>.</p> <table border="1" style="margin-left: auto; margin-right: auto;"> <tr> <td style="text-align: center;">Note</td> </tr> <tr> <td style="text-align: center;">This communication object is only available in the <i>Control with slat adjustment</i> operation mode.</td> </tr> </table> <p>If a telegram is received at this communications object, the slats are then positioned in accordance with the received value. If the blind/shutter is currently moving, the movement will continue to the target position and only then are the slats positioned.</p> <p>Telegram value: 0 = OPEN slats ... = Intermediate position 255 = CLOSE slats</p>					Note	This communication object is only available in the <i>Control with slat adjustment</i> operation mode.
Note						
This communication object is only available in the <i>Control with slat adjustment</i> operation mode.						
15	Move to position 1, 2	Output A	1 bit DPT 1.002	C, W		
16	Move to position 3, 4					
<p>This communication object is enabled if, in the parameter window <i>A: Positions/presets</i>, p.72, the parameter <i>Enable communication objects "Move to/set positions 1-4" 1 bit</i> was selected with option <i>Yes</i>.</p> <p>If a telegram is received at this communication object, then the blind/shutter is moved to the saved preset position. In the <i>Control with slat adjustment</i> operation mode, slat positioning is undertaken according to the saved preset value after the position has been reached. If a telegram with the value 0 is received, the blind/shutter moves to the parameterized position 1 (or position 3). If a telegram with the value 1 is received, the blind/shutter moves to the parameterized position 2 (or position 4).</p> <p>Telegram value: 0 = Move to position 1 or position 3 1 = Move to position 2 or position 4</p>						
17	Set position 1, 2	Output A	1 bit DPT 1.002	C, W		
18	Set position 3, 4					
<p>This communication object is enabled if, in the parameter window <i>A: Positions/presets</i>, p.72, the parameter <i>Enable communication objects "Move to/set positions 1-4" 1 bit</i> was selected with option <i>Yes</i>.</p> <p>If a telegram is received at this communications object, then the current position of the blind/shutter is accepted as the new preset value. If the telegram value 0 is received, then the current position is saved as the preset value for position 1 (or position 3). If the telegram value 1 is received, then the current position is saved as the preset value for position 2 (or position 4).</p> <p>The changed preset values are retained on a bus voltage failure. When the device is reprogrammed, it is possible to set via a parameter if the values parameterized in advance should be overwritten.</p> <p>Telegram value: 0 = Set position 1 or position 3 1 = Set position 2 or set position 4</p>						

No.	Function	Object name	Data type	Flags		
19	Trigger travel detection	Output A	1 bit DPT 1.003	C, W		
<p>This communication object is enabled when, in the parameter window <i>A: Drive</i>, p. 63, the parameter <i>Detect travel times (UP/DOWN)</i> was selected with the option <i>Yes – via detection of end positions</i>.</p> <table border="1"> <tr> <td>Note</td> </tr> <tr> <td>This communication object is only available for devices of type JRA/S x.y.5.1 and triggers automatic travel time detection via current detection.</td> </tr> </table> <p>In so doing, the blind/shutter is first moved to the upper end position. Then, the blind/shutter moves to the lower end position and then moves back to the upper end position. The determined total travel times are saved for the upward and downward movements and the blind/shutter moved to the parameterized position after travel detection.</p> <p>Currently active travel detection is interrupted by</p> <ul style="list-style-type: none"> ▪ Safety telegrams, e.g. Weather alarm, Forced operation, e.g. ▪ Activation of manual operation (only for JRA/S x.y.5.1 and JRA/S x.y.2.1) ▪ Direct travel or position telegrams, e.g. UP, DOWN, etc. <p>If automatic sun protection is activated, then this is interrupted for the length of travel detection.</p> <p>Travel detection can also be performed when direct operation is disabled.</p> <p>Telegram value: 0 = No reaction 1 = Trigger travel detection (UP > DOWN > UP)</p>					Note	This communication object is only available for devices of type JRA/S x.y.5.1 and triggers automatic travel time detection via current detection.
Note						
This communication object is only available for devices of type JRA/S x.y.5.1 and triggers automatic travel time detection via current detection.						
19	Trigger reference movement	Output A	1 bit DPT 1.008	C, W		
<p>This communication object is enabled if, in the parameter window <i>A: Drive</i>, p. 63, the parameter <i>Enable communication object "Trigger reference movement" 1 bit</i> is selected with the option <i>Yes</i>.</p> <table border="1"> <tr> <td>Note</td> </tr> <tr> <td>This communication object is only available in the <i>Control with or without slat adjustment</i> operation modes.</td> </tr> </table> <p>A reference movement is triggered using this communication object. On reception of a telegram, the blind/shutter is moved to the very top or very bottom. The saved position is updated and the blind/shutter then moved to the parameterized position after the reference movement.</p> <p>If automatic control is activated, the reference movement interrupts automatic control until the reference position has been reached. However, it is not activated but continues to receive automatic telegrams. These are executed after the reference movement has been completed.</p> <p>If, during a reference movement, a direct or automatic movement or position telegram is received, then the reference movement is performed first and only then is the received target position approached.</p> <p>STOP or step telegrams are ignored during a reference movement. No referencing can be performed if a safety function is activated. A currently active reference movement is interrupted by</p> <ul style="list-style-type: none"> ▪ Safety telegrams, e.g. Weather alarm, Forced operation, e.g. ▪ Activation of manual operation (only for JRA/S x.y.5.1 and JRA/S x.y.2.1) <p>A reference movement can also be performed when direct operation is disabled.</p> <p>Telegram value: 0 = Reference movement fully upwards 1 = Reference movement fully downwards</p>					Note	This communication object is only available in the <i>Control with or without slat adjustment</i> operation modes.
Note						
This communication object is only available in the <i>Control with or without slat adjustment</i> operation modes.						
20	8-bit scene	Output A	1-byte DPT 18.001	C, W		
<p>This communication is enabled when, in the parameter window <i>A: Functions</i>, the parameter <i>Activate 8-bit scene</i> was selected with the option <i>Yes</i>.</p> <p>This communication can be used to allocate each output to up to 18 scenes using a pre-parameterizable position.</p> <p>If there is a bus voltage failure, then the saved scene values remain intact, as is also the case when the <i>No</i> option in the parameter <i>Overwrite scene on download</i> was selected.</p> <p>You can find an 8-bit scene code table with all the possible combinations in the appendix.</p>						

No.	Function	Object name	Data type	Flags
21	Activation of autom. control	Output A	1 bit DPT 1.003	C, R, T, U
<p>If a telegram with the value 1 is received at this communication object, automatic control is activated for the corresponding output. This means that the output can be controlled via the automatic communication objects <i>Sun</i>, <i>Presence</i>, <i>Heating</i>, <i>Cooling</i>, <i>Receive room temperature</i> as well as <i>Move to height for sun [0...255]</i> and <i>Adjust slat for sun [0...255]</i>.</p> <p>If a telegram with the value 0 is received, then the output no longer reacts to incoming telegrams at the automatic communication objects. If the output is currently executing an automatic travel telegram, then the movement is completed first.</p> <p>If automatic control is activated, then the output updates using the saved values of the communication objects in the automatic communication objects.</p> <p>If there is a reference movement, active automatic control is interrupted until the reference position has been reached. However, it is not activated but continues to receive automatic telegrams. These are executed after the reference movement has been completed.</p> <p>Telegram value: 0 = Automatic control deactivated 1 = Automatic control activated</p>				
22	Sun	Output A	1 bit DPT 1.002	C, R, T, U
<p>Incoming telegrams at this communication object are only considered if automatic control is activated. If a telegram with the value 1 is received at the communications object <i>Sun</i>, the blind/shutter moves to the parameterized <i>Position for sun = 1</i>. If a telegram with the value 0 is received, the blind/shutter moves to the parameterized <i>Position for sun = 0</i>.</p> <p>The reaction to incoming telegrams can be delayed in its execution via the parameter <i>Delay for sun = X</i>, in order to prevent the blinds/shutters from continuously moving up and down in changeable weather. If a telegram with the opposing value is received within the delay time, the <i>Position for sun = 1</i> is not executed. The blind/shutter remains in the <i>Position for sun = 0</i> or vice versa.</p> <p>If, for <i>Position for sun = X</i>, the option <i>Receive position via object (8-bit)</i> is set, then, after the delay time has elapsed, the output moves to the position most recently received on the communication objects <i>Move to height for sun [0...255]</i> (operation mode <i>Control with slat adjustment</i> and operation mode <i>Control without slat adjustment</i>), as well as <i>Adjust slat for sun [0...255]</i> (only operation mode <i>Control with slat adjustment</i>).</p> <p>Telegram value: 0 = No sun 1 = Sun</p>				
23	Move to height for sun [0...255]	Output A	1-byte DPT 5.001	C, R, T, U
<p>Incoming telegrams at this communication object are only executed if automatic control is activated and if a telegram with the value 1 has been received at the communication object <i>Sun</i>. The blind/shutter is then positioned to correspond with the received value.</p> <p>Telegram value: 0 = Upper ... = Intermediate position 255 = Lower</p> <p>After the target position is reached, the slats will assume the same position which they had before the movement started. If a telegram is received during movement at the communication object <i>Adjust slat for sun [0...255]</i>, then the slats are set to the corresponding received value after the target position has been reached.</p>				

No.	Function	Object name	Data type	Flags
24	Adjust slat for sun [0...255]	Output A	1-byte DPT 5.001	C, R, T, U
<p>Incoming telegrams at this communication object are only executed if automatic control is activated and if a telegram with the value 1 has been received at the communication object <i>Sun</i>. The slats are then positioned to correspond with the received value.</p> <div style="border: 1px solid black; padding: 5px; margin: 10px 0;"> <p>Note</p> <p>This communication object is only available in the <i>Control with slat adjustment</i> operation mode.</p> </div> <p>Telegram value: 0 = OPEN slats ... = Intermediate position 255 = CLOSE slats</p> <p>If the blind/shutter is currently moving, the movement will continue to the target position and the positioning of the slats is then undertaken.</p>				
25	Presence	Output A	1 bit DPT 1.002	C, R, T, U
<p>Incoming telegrams at this communication object are only considered if automatic control is activated. If a telegram with the value 1 is received at this communication object, the automatic sun protection is activated and the blind/shutter is controlled in accordance with the parameterized <i>Position for sun = X</i>.</p> <p>If a telegram with the value 0 is received at this communication object, then automatic heating/cooling is activated and the blind/shutter is controlled in accordance with the parameterized <i>Position for HEATING = 1 and sun = X</i> or <i>Position for COOLING = 1 and sun = X</i>.</p> <p>The reaction to incoming telegrams can be delayed in its execution via the parameter <i>Delay for presence = X</i>, in order to prevent the blinds/shutters continuously moving up and down when people enter and leave the room frequently. If a telegram with the opposing value is received within the delay time, then the heating/cooling target position is not moved to and the blind/shutter remains in the automatic sun protection target position or vice versa.</p> <p>Telegram value: 0 = e.g. no-one present (> Automatic heating/cooling active) 1 = e.g. persons present (> Automatic sun protection active)</p> <p>Observe the telegram values for communication objects 26/27 and possibly 28 (heating/cooling)!</p> <div style="border: 1px solid black; padding: 5px; margin: 10px 0;"> <p>Note</p> <p>If automatic heating/cooling is to be programmed, but no automatic sun protection is to be programmed, then the communication object <i>Presence</i> has to remain without logical linking. Accordingly, the value 0 is automatically present in this communication object. Thus automatic heating/cooling is immediately activated, as soon as automatic control has been activated via the communication object <i>Activation of autom. control</i>.</p> </div>				
26 27	Heating Cooling	Output A	1 bit DPT 1.002	C, R, T, U
<p>Incoming telegrams to these communication objects are only executed if automatic control is activated and if a 0 has been received on the <i>Presence</i> communication object.</p> <p>If a telegram with the value 1 is received at the communication object <i>Heating</i>, then the output will move to the parameterized <i>Position for HEATING = 1 and sun = 1</i> or <i>Position for HEATING = 1 and sun = 0</i>.</p> <p>If a telegram with the value 1 is received at the communication object <i>Cooling</i>, then the output will move to the parameterized <i>Position for COOLING = 1 and sun = 1</i> or <i>Position for COOLING = 1 and sun = 0</i>.</p> <p>If both communication objects have most recently received a 0 or if both have received a 1, then automatic heating/cooling is deactivated and the output is controlled via automatic sun protection.</p> <p>Telegram value: 0 = Do not HEAT/do not COOL 1 = HEATING/COOLING</p>				

No.	Function	Object name	Data type	Flags
28	Receive room temperature	Output A	2-byte DPT 9.001	C, R, T, U
<p>Incoming telegrams at this communication object are only executed if automatic control is activated and if a 0 was received at the <i>Presence</i> communications object and Overheat control was activated.</p> <p>The room temperature, for example from a room thermostat, can be received via this communication object. The blind/shutter moves to the parameterized position as soon as the parameterized threshold value has been exceeded and the value 1 was received on the communication objects <i>Heating</i> and <i>Sun</i>. Thus, for example, during the heating period (winter), overheating of the room can be avoided during periods of sunshine and simultaneous absence.</p>				
29	Disable/enable autom. control	Output A	1 bit DPT 1.001	C, R, T, U
<p>This communication object is enabled when automatic control is active and in the parameter window <i>A: Automatic sun protection</i>, p. 75, the parameter <i>Toggling to automatic control</i> was selected with the option <i>Disable/enable via object</i>.</p> <p>If a telegram with the value 1 is received at this communication object, automatic control is disabled and the output can only be controlled directly via communication objects. Automatic control can no longer be activated via the communication object <i>Activation of autom. control</i>.</p> <p>If a telegram with the value 0 is received at this communication object, automatic control can be reactivated again for the corresponding output.</p> <p>Telegram value: 0 = Automatic control enabled 1 = Automatic control disabled</p>				
30	Disable/enable direct control	Output A	1 bit DPT 1.003	C, R, T, U
<p>This communication object is enabled when automatic control is active and in the parameter window <i>A: Automatic sun protection</i>, p. 75, the parameter <i>Toggling to direct control</i> was selected with the option <i>Disable/enable via object</i>.</p> <p>If a telegram with the value 1 is received on this communication object, the incoming telegrams will not be executed directly at the communication objects (with the exception of <i>Travel detection/Trigger reference movement</i>).</p> <p>If a telegram with the value 0 is received at this communication object, direct operation is enabled. However, direct telegrams (UP, DOWN, etc.) are only executed when automatic control is deactivated. Otherwise, automatic control has a higher priority and direct telegrams are not taken into account.</p> <p>Telegram value: 0 = Direct operation enabled 1 = Direct operation disabled</p>				
31	Block	Output A	1 bit DPT 1.003	C, R, T, U
<p>If a telegram with the value 1 is received, the output can be moved to a parameterized position. Operation of the output via direct automatic communication objects is disabled. When the disabling is lifted, the blind/shutter is moved to the parameterized position for the removal of Wind alarm, Block and Forced operation. Operation via the direct and automatic communication objects is enabled again.</p> <p>Telegram value: 0 = Operation enabled 1 = Operation disabled</p>				
32	Forced operation 1 bit	Output A	1 bit DPT 1.003	C, R, T, U
<p>If a telegram with the value 1 is received, the output can be moved to a parameterized position. Operation of the output via direct automatic communication objects is disabled. When the disabling is lifted, the blind/shutter is moved to the parameterized position for the removal of Wind alarm, Block and Forced operation. Operation via the direct and automatic communication objects is enabled again.</p> <p>Telegram value: 0 = Operation enabled 1 = Operation disabled/Forced operation active</p>				

No.	Function	Object name	Data type	Flags
32	Forced operation 2 bit	Output A	2 bit DPT 2.002	C, R, T, U
<p>If a telegram with the value 2 (binary 10) is received at this communication object, then the blind/shutter is raised. Operation via direct and automatic communication objects is disabled.</p> <p>If a telegram with the value 3 (binary 11) is received, then the blind/shutter is lowered. Operation via direct and automatic communication objects is disabled.</p> <p>Forced operation is rescinded by the values 0 (binary 00) or 1 (binary 01). The blind/shutter then moves to the parameterized position for the removal of Wind alarm, Block and Forced operation. Operation via the direct and automatic communication objects is enabled again.</p> <p>Telegram value: 0 (binary 00) = Operation enabled 1 (binary 01) = Operation enabled 2 (binary 10) = OPEN/Operation disabled 3 (binary 11) = CLOSED/Operation disabled</p>				
33	Status Height [0...255]	Output A	1-byte DPT 5.001	C, R, T
<p>The output sends the current positioned height of the blind/shutter to this communication object. The current position is sent after completion of a movement.</p> <p>Telegram value: 0 = Top ... = Intermediate position 255 = Bottom</p>				
34	Status Slat [0...255]	Output A	1-byte DPT 5.001	C, R, T
<p>The output sends the current position of the slat setting to this communication object. The current position is sent after completion of a movement.</p> <div style="border: 1px solid black; padding: 5px; margin: 10px 0;"> <p>Note</p> <p>This communication object is only available in the <i>Control with slat adjustment</i> operation mode.</p> </div> <p>Telegram value: 0 = OPEN slats ... = Intermediate position 255 = CLOSE slats</p>				
35	Status Upper end position	Output A	1 bit DPT 1.008	C, R, T
36	Status Lower end position			
<p>The output sends information to this communication object as to whether the blind/shutter is, or is not, in the upper or lower end limit position.</p> <p>Telegram value: 0 = Blind/shutter not in upper or lower end position 1 = Blind/shutter in upper or lower end position</p> <p>The upper/lower status position is sent after the upper/lower end position is reached or exited.</p>				
37	Status Operability	Output A	1 bit DPT 1.002	C, R, T
<p>The output sends information to this communication object if the output operation is enabled or blocked. Operation is blocked if either one of the safety functions has been activated, e.g. wind alarm, or if the device is in manual operation.</p> <p>Example: An LED on the push button can display to the user that the operation of the output is not possible via push buttons and the automatic control also cannot be activated.</p> <p>Telegram value: 0 = Operation enabled 1 = Operation disabled</p>				

No.	Function	Object name	Data type	Flags
38	Status Automatic	Output A	1 bit DPT 1.002	C, R, T
<p>The device sends information to this communication on whether automatic control has been activated or deactivated.</p> <p>Telegram value: 0 = Automatic control deactivated 1 = Automatic control activated</p>				
39	Status information	Output A	2-byte Non DPT	C, R, T
<p>The device uses this communication object to send the status information to each output. The Low Byte (Bit no. 0...7) contains the information on the current operating state. Only one status can ever be active. The High Byte (Bit no. 8...15) is not assigned in the operation mode <i>Ventilation flaps, switch mode</i>. The current status or communication object value is sent after a change or request by the communication object <i>Request status values</i>. For further information, see: Code table Scene (8 bit), DPT 18.001, p. 122 and Code table for communication object Status information (Bit 0...7), p. 123 in the appendix</p> <p>Low Byte</p> <p>Bit 0: Manual operation Telegram value 0: Inactive Telegram value 1: Active</p> <p>Bit 1: Block active Telegram value 0: Inactive Telegram value 1: Active</p> <p>Bit 2: Forced operation Telegram value 0: Inactive Telegram value 1: Active</p> <p>Bit 3: Frost alarm Telegram value 0: Inactive Telegram value 1: Active</p> <p>Bit 4: Rain alarm Telegram value 0: Inactive Telegram value 1: Active</p> <p>Bit 5: Wind alarm Telegram value 0: Inactive Telegram value 1: Active</p> <p>Bit 6: Automatic sun protection Telegram value 0: Inactive Telegram value 1: Active</p> <p>Bit 7: Automatic heating/cooling Telegram value 0: Inactive Telegram value 1: Active</p> <p>High Byte</p> <p>Bit 8: Drive error (no current detection on activated drive, only for devices of type JRA/S x.y.5.1) Telegram value 0: No error Telegram value 1: Error</p> <p>Bit 9: Drive in motion or relays activate drive Telegram value 0: No Telegram value 1: Yes</p> <p>Bit 10: Drive turns to CLOSED or relays control drive in the CLOSED direction Telegram value 0: No Telegram value 1: Yes</p> <p>Bit 11: Drive turns to OPEN or relays control drive in the OPEN direction Telegram value 0: No Telegram value 1: Yes</p> <p>Bit 12: Send and receive delay active Telegram value 0: No Telegram value 1: Yes</p> <p>Bit 13...15 Not assigned</p>				

3.3.4

Communication objects Output A...X Operation mode *Ventilation flaps, switch mode*

No.	Function	Object name	Data type	Flags
10	Flaps open-closed/on-off	Output	1 bit DPT 1.009	C, W
<p>If a telegram with the value 1 is received at this communication object, then the output contact closes. The connected ventilation flaps are thus opened and connected consumers are switched on. If a telegram with the value 0 is received, then the ventilation flaps or the consumers are switched off. The output contact returns to the neutral middle position. The polarity of the communication object can be changed via the parameter <i>Invert output</i>.</p> <p>Telegram value: 0 = CLOSED/OFF 1 = OPEN/ON</p>				
31	Block	Output A	1 bit DPT 1.003	C, R, T, U
<p>If a telegram with the value 1 is received the output will move to a parameterized position. Operation of the output via direct automatic communication objects is disabled. When the disabling is lifted, the blind/shutter moves to the parameterized position for the removal of Wind alarm, Block and Forced operation. Operation via the direct and automatic communication objects is enabled again.</p> <p>Telegram value: 0 = Operation enabled 1 = Operation disabled</p>				
32	Forced operation 1 bit	Output A	1 bit DPT 1.003	C, R, T, U
<p>If a telegram with the value 1 is received the output will move to a parameterized position. Operation of the output via direct automatic communication objects is disabled. When the disabling is lifted, the blind/shutter moves to the parameterized position for the removal of Wind alarm, Block and Forced operation. Operation via the direct and automatic communication objects is enabled again.</p> <p>Telegram value: 0 = Operation enabled 1 = Operation disabled/Forced operation active</p>				
32	Forced operation 2 bit	Output A	2 bit DPT 2.001	C, R, T, U
<p>If a telegram with the value 2 (binary 10) is received at this communication object, then the output contact closes. The connected ventilation flaps are thus opened and connected consumers are switched on. Operation via direct communication objects is disabled.</p> <p>If a telegram with the value 3 (binary 11) is received, then the ventilation flaps or the consumers are switched off. Operation via direct communication objects is disabled.</p> <p>Forced operation is rescinded by the values 0 (binary 00) or 1 (binary 01). The output then activates the position on rescinding of Wind alarm, Block and Forced operation. Operation via the direct communication objects is enabled again.</p> <p>Telegram value: 0 (binary 00) = Operation enabled 1 (binary 01) = Operation enabled 2 (binary 10) = OPEN/ON - Operation disabled 3 (binary 11) = CLOSED/OFF - Operation disabled</p>				
33	Status Open-closed/on-off	Output A	1 bit DPT 1.011	C, R, T
<p>The output sends information to this communication object on whether the ventilation flap is opened or closed or whether connected consumers are switched on or switched off. The current status is sent after a telegram is executed. If a new telegram is received in the interim, then the current status is only sent after the execution of the last telegram.</p> <p>Telegram value: 0 = Ventilation flaps CLOSED or switching contact OFF 1 = Ventilation flaps OPEN or switching contact ON</p>				

No.	Function	Object name	Data type	Flags
37	Status Operability	Output A	1 bit DPT 1.002	C, R, T
<p>The output sends information to this communication object if the output operation is enabled or blocked. Operation is blocked if either one of the safety functions has been activated, e.g. wind alarm, or if the device is in manual operation.</p> <div style="border: 1px solid black; padding: 5px; margin: 10px 0;"> <p>Example</p> <p>An LED on the push button can display to the user that the operation of the blind/shutter is not possible via push buttons.</p> </div> <p>Telegram value: 0 = Operation enabled 1 = Operation disabled</p>				
39	Status information	Output A	2-byte Non DPT	C, R, T
<p>The device uses this communication object to send the status information to each output. The Low Byte (Bit no. 0...7) contains the information on the current operating state. High Byte (Bit no. 8...15) contains additional information, specially for the connected drive. The current status or communication object value is sent after a change or request by the communication object <i>Request status values</i>. For further information, see: Code table Scene (8 bit), DPT 18.001, p. 122 and Code table for communication object Status information (Bit 0...7), p. 123 in the appendix.</p> <p>Low Byte</p> <p>Bit 0: Manual operation Telegram value 0: Inactive Telegram value 1: Active</p> <p>Bit 1: Block active Telegram value 0: Inactive Telegram value 1: Active</p> <p>Bit 2: Forced operation Telegram value 0: Inactive Telegram value 1: Active</p> <p>Bit 3: Frost alarm Telegram value 0: Inactive Telegram value 1: Active</p> <p>Bit 4: Rain alarm Telegram value 0: Inactive Telegram value 1: Active</p> <p>Bit 5: Wind alarm Telegram value 0: Inactive Telegram value 1: Active</p> <p>Bit 6: Not used</p> <p>Bit 7: Not used</p> <p>High Byte</p> <p>Bit 8...15: Not used</p>				

4 Planning and application

In this section, you will find useful information on the planning and use of the blind/roller shutter actuator. You can find more information on the planning and use in the application manual *Blind control* at www.abb.de/knx.

4.1 Travel times (blinds, roller shutters, etc.)

The travel time is the time which the blind/shutter requires to perform a movement from the very top to the very bottom and vice-versa. The travel times for UP or DOWN can be determined and input separately. If the JRA/S receives a telegram to travel upwards or downwards, then the appropriate output is switched and the blind/shutter moved in the required direction.

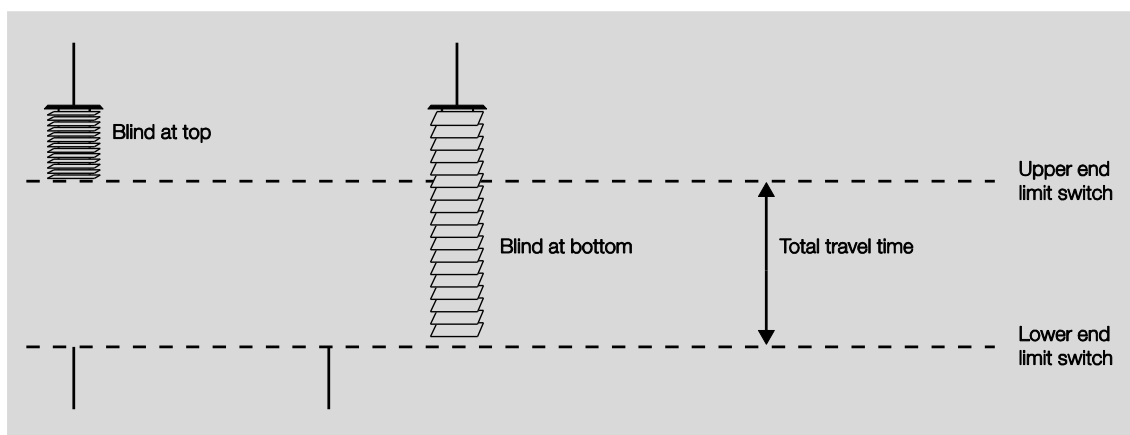

The blind/shutter is moved in this direction until the output receives a STOP telegram or the upper or lower end position and the drive is switched off using the limit switch. If the drive is switched off using the limit switch, then the corresponding output contact remains closed until the parameterized travel time has elapsed. In addition, the travel time can be extended using a parameterizable overflow, see the parameter *Disconnect output from power after*. Only then is there no more voltage at the output. The overflow time is not taken into account when a value not equal to 100 % is set for the parameter *Slat position on reaching lower end position*. In this case, the output sets the slats according to the parameterized value on reaching the lower end position.

Control with slat adjustment (blinds, vertical blinds, etc.)

After an UP movement of the blind, the slats are usually open (horizontal slat position). If the blind is now moved downwards, the slats are first closed (vertical slat position) and the blind moves downwards. If the blind is now moved upwards again, then the slats are first opened (horizontal slat position) and then moved upwards (see Fig.).

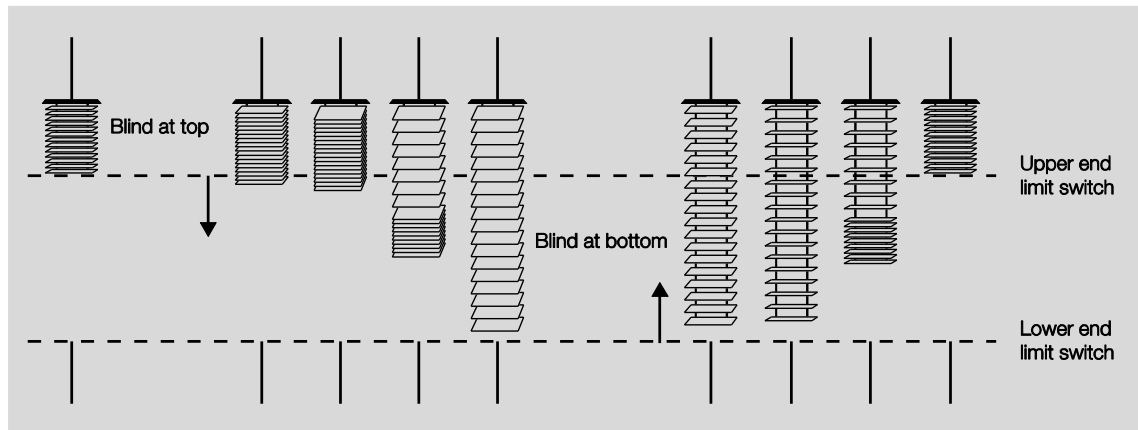

To adjust the slat angle in a targeted manner, short movements can be executed. This means that, for a short parameterized time (the so-called Duration of slat adjustment), the blind will be moved in a stepped manner in the required direction, thus adjusting the slats. The smaller the Duration of slat adjustment is, the more accurately the slat angle can be adjusted.

4.1.1 Automatic travel detection

Note			
Automatic travel detection is only available for devices of type JRA/S x.y.5.1. In the case of devices of type JRA/S 4.230.5.1 and JRA/S 8.230.5.1, automatic travel detection via detection of end positions must always be parameterized in pairs for both outputs of a root (e.g. A+B, C+D, etc.). The connected drives should be of the same type or have the same current consumption. Mixed parameterization is not permitted and can lead to errors in travel time detection. Example:			
Parameter	Output A Parameter option	Output B Parameter option	Note
Detect travel times (up/down)	Yes – via detection of end positions	Yes – via detection of end positions	OK
Detect travel times (up/down)	No – set travel times	Yes – via detection of end positions	Not permitted

The travel times of the devices are determined using the automatic travel detection. Current recognition is used to measure the length of the current flow, required by the drive for the movement from the lower to the upper end position and vice-versa. The advantage of this is that aging processes and temperature-related influences on the blind/shutter, e.g. expansion of the ribbons or cords of blinds, can be compensated. This allows more accurate positioning of the blind/shutter. In addition, travel detection simplifies and accelerates commissioning and sends an error message, if the current flow is interrupted on the connected drive.

Travel detection takes place automatically during operation or optionally via the communication object [Trigger travel detection](#). The determined travel times serve as the basis for the calculation and activation of positions or for position feedback.

Important
<p>The travel times must be at least 3 seconds long, in order to be taken into account by the travel detection. Travel times of less than 3 seconds are signaled as drive errors.</p> <p>At the factory, internal travel times of 60 seconds for an UP or DOWN movement are preset in the as-delivered state. If a device is freshly programmed or is reprogrammed with automatically determined and saved travel times or installed in a different system, then the following must be taken into account:</p> <p>If the parameter <i>Delete saved travel times after download</i> is parameterized with Yes, then the travel times previously saved in the devices are overwritten with the default settings (infinite travel time). The travel times measured during the first travel detection are then saved and declared valid.</p> <p>If a further run time measurement occurs, then this is completed. The newly-measured value is then compared with the currently saved value. If the deviation is > 5 %, then the output switches off and an error message is output.</p> <p>Bit no. 8 <i>Drive error</i> in the communication object <i>Status information</i> is set.</p> <p>The LEDs of the affected output flash alternately.</p> <p>The new travel times are only valid and are saved when</p> <ul style="list-style-type: none"> • A continuous movement takes place from the lower to the upper end position and vice-versa or • The travel times were determined using <i>Trigger travel detection</i>.

4.1.2 Specifying travel times

Alternatively to automatic travel detection, on devices of type JRA/S x.y.5.1, it is possible to use the manual travel detection method via the application. In so doing, the travel times are measured from the lower to the upper end position and vice-versa, e.g. using a stopwatch. The measured values are then entered in the appropriate ETS parameter. This method must be used on devices without travel detection (JRA/S x.230.2.1 and JRA/S x.230.1.1).

Important

The travel times are used to determine the current position of the blind/shutter during operation. For this reason, the travel times should be measured and parameterized as accurately as possible or determined using the automatic travel detection (only for type JRA/S x.y.5.1). For position movements, automatic control or status messages in particular, precise travel times are the basis for an exact calculation and positioning of the blind/shutter.

4.1.3 Start-up/coasting delay and minimum run time

Some drives do not provide full output immediately, but only after a starting delay of a few milliseconds. Other drives continue to run for a few milliseconds (stopping delay) or have a minimum run time. These parameters must only be entered if you require an even more exact positioning of the blind/shutter.

Important

Usually, the standard settings of these parameters are sufficient for correct operation. If changes are made to these parameters in the user-defined setting, then the technical data of the appropriate drive manufacturer must be observed.

4.2 Blind/slat settings

Control with slat adjustment

Two methods are available for controlling the slats and calculation the turning times.

1. Slat adjustment time using the duration of a slat adjustment

In this method, the number and duration of the slat adjustment(s) to tilt the slats from completely closed to completely open are specified. The maximum number of slat adjustments is used to determine the current position of the slats during operation. The maximum number of slat adjustments must be counted by the commissioner and entered as a parameter.

2. Slat adjustment time using duration to turn slats

In this method, the time is first determined which the slat requires to tilt from completely closed to completely open. Then the desired number of slat adjustments (steps) is entered, with which the slats are to be adjusted from fully closed to fully open. The JRA/S then calculates the time for a slat adjustment.

Limitation of the traveling range

For specific applications, the traveling range can be limited for the user.

Example
The opening and closing of windows, doors or skylights is limited to a range of 0...20% opening for a specific circle of users, whilst the janitor is able to operate them fully.

In addition to a limitation of the traveling range, it is possible to specify whether the upper and lower limitation is to be executed for direct telegrams and/or for automatic telegrams.

Dead times

In rare cases, mechanical dead times of the blinds/shutters or slats must be compensated. Parameters are available for this, which compensate the dead times, allowing accurate positioning.

Important
Usually, the standard settings of these parameters are sufficient for correct operation. If changes are made to these parameters in the user-defined setting, then the technical data of the appropriate blind/shutter manufacturer must be observed.

Tensioning of the blinds/shutter/slot positioning

This function is used to tension or tauten textile blinds/shutters or to adjust the so-called slot positioning on slat curtains. In so doing, the blind/shutter is stopped at the end of a DOWN movement and moved in the opposite direction for a parameterizable time. In so doing, for example, awning clothes or skylights and ventilation slots on a slat curtain can be adjusted.

4.3 Safety functions

Wind alarm

To protect the blind/shutter against wind and storms, the JRA/S can receive wind alarm telegrams (1 bit). If a wind alarm occurs, then the blind/shutter is moved to the parameterized wind alarm position and cannot be operated until the wind alarm is deactivated again.

The JRA/S can be activated by up to 3 wind monitors. It is possible to select freely for each output which of the three monitors should be reacted to and whether the *Wind alarm* function should be activated for this function at all. In addition, the position for wind alarms can be set separately for each output. The wind monitors assigned to an output are linked by an OR operation, i.e. if an alarm is triggered on at least one of the assigned wind monitors, then the alarm position will be moved to.

Rain alarm and frost alarm

To protect the blind/shutter, e.g. awnings, against rain or to avoid freezing during periods of frost, the JRA/S can receive 1-bit rain alarm and frost alarm telegrams. If an alarm occurs, then the blind/shutter is moved to a parameterized position and cannot be operated until the alarm is rescinded. The position for the rain alarm and the position for the frost alarm can be set separately for each output.

Note on wind, rain and frost alarm

The wind monitors and the rain and frost sensors are monitored cyclically by the JRA/S, i.e. the sensors send the alarm status cyclically and the JRA/S expects this signal. If there is no signal, then the JRA/S assumes that the sensor is defective or that the bus line has been interrupted. All the blinds/shutters, upon which the sensor has an effect, move to the parameterized alarm position and operation is disabled. The monitoring time in the JRA/S should be at least double the cyclic sending time of the wind monitor or rain/frost sensor. If there is no signal, e.g. due to excessive bus load, this stops the blinds/shutters from being moved to the position for wind, rain or frost alarm.

When a wind, rain or frost alarm is rescinded, the blind/shutter is moved to the parameterized position for rescinding of Weather alarm, Block or Forced operation and operation is enabled.

ABB i-bus[®] KNX

Planning and application

Block

The *Block* function can be used to move an output of the JRA/S in a targeted manner to a parameterized position using a 1-bit telegram and disable operation. When the *Block* function is recalled, the blind/shutter is moved to a parameterized position for blocking and operation is disabled. On rescinding, the blind/shutter is moved to the parameterized position for rescinding of Weather alarm, Block or Forced operation and operation is enabled.

Example
With appropriate parameterization, this function can be used to monitor a window. If the window is open, then the operation of an inner blind/shutter (inner blind or roller blind).

Forced operation

Each blind/shutter can be moved individually to a forced position and operation disabled using a telegram (1 bit or 2 bit). When Forced operation is activated, the output is also informed of the position to which the blind/shutter should be moved. Operation of the blind/shutter is then disabled. When Forced operation is rescinded, the blind/shutter is moved to the parameterized position for rescinding of Weather alarm, Block or Forced operation and operation is enabled.

The *Forced operation* function is suitable, for example, for moving blinds and roller shutters upwards when the windows are being cleaned. At the same time, operation of the blind/shutter is disabled to prevent the cleaning personnel from being put at risk through unexpected movement.

Priority of safety functions

The *Wind alarm*, *Rain alarm*, *Frost alarm*, *Block* and *Forced operation* safety functions have priority over every other function. If, therefore, one of these functions has been activated for an output, then the operation of the output is disabled for other movements. A priority can be defined within the safety functions, in order to control the blind/shutter in a targeted manner, if more than one safety function is activated at the same time.

Example
A parameter is used to specify that the forced movement during window cleaning has priority over a wind alarm, meaning that the cleaning personnel is not impeded by a Wind alarm movement telegram when cleaning the slats.

4.4 Positions

Reference movement

Each output continuously determines the current position of the blind/shutter as well as the position of the slat angle using the duration of the individual movements. Over longer periods of time, slight inaccuracies in position detection can occur due to temperature variations and aging processes. For this reason, the JRA/S use the upper and lower end position for clear determination of the current position of the blind/shutter. Each time the blind/shutter is located in the upper or lower end position, the position is updated in the memory of the device.

If, during normal operation, the end positions are not reached, then a telegram can be used to trigger a reference movement to the very top or the very bottom. Depending on the parameterization, after the reference movement, the blind/shutter will remain in the reference position or will move back to the saved position.

Direct and indirect movement to the position

The *Move to position* parameter can be used to set whether the blind/shutter is to move directly from its current position to the target position in the case of a movement command, or whether, on receipt of a *Move to position* telegram, a reference movement is to be carried out indirectly via the top or indirectly via the bottom.

Move to position 0...100 %

The blind/shutter can be moved into any position via an 8-bit value. In the *Control with slat adjustment* (blind) operation mode, the slats can also be positioned into any angle via an 8-bit value. In this way, it can be decided for each movement telegram to which position the blind/slat should move, e.g. it is possible to set the position via a display or a visualization terminal.

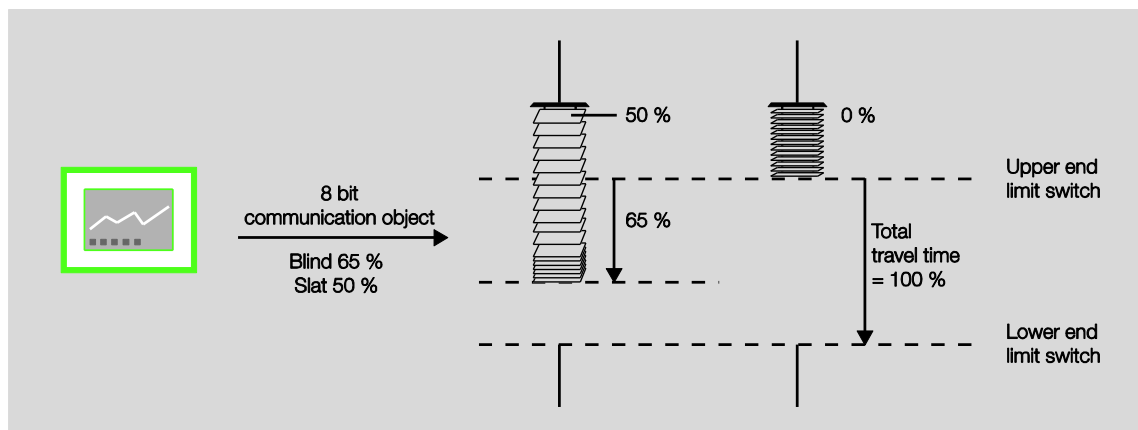

Move to preset position

For each output, it is possible to parameterize up to 4 preset positions individually, which are then recalled via a 1 bit telegram. When moving into one of these preset positions, the target position must be set in advance, either via the parameters during programming or by setting a preset position. This preset target position can then, for example, be recalled as often as required by pressing a push button.

ABB i-bus[®] KNX Planning and application

Set preset position

The preset position can be changed very easily via a 1-bit telegram. To do so, the blinds are moved into the required new preset position using UP/DOWN telegrams as well as STOP/slat adjustment UP/DOWN telegrams. The new position is transferred to the memory of the device as a new preset position via a 1-bit telegram.

Example

The blinds are moved into a preset position after a short push button action and the current position is adopted as the new preset position after a long push button action.

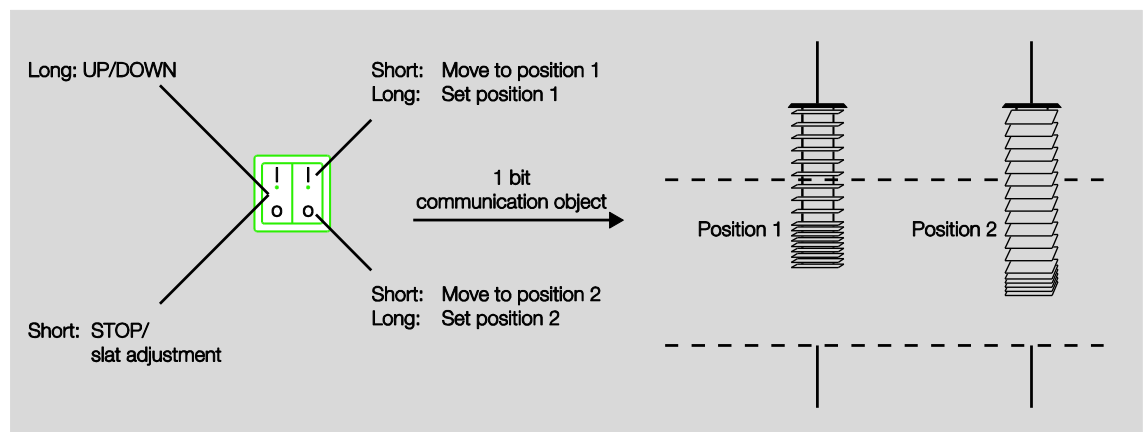

If there is a bus voltage failure, the saved preset values are retained. During programming, it is possible to set via a parameter if the saved values should be overwritten by the parameterized values.

8-bit scene

In the 8-bit scene, up to 64 scenes are managed using a single group address. An 8-bit scene telegram contains the following information:

- Scene number (1...64) and
- Recall/save scene.

The JRA/S receives the telegram. All the outputs allocated to the received scene number via a parameter move to the recalled scene position or save their current position as the new specified value for this scene number.

A code table for the communication object *Scene* with all the possible combinations can be found in the appendix.

Each individual output of the device can be assigned to up to eighteen 8-bit scenes. For each assignment, the settings for the height and slat position of the blind/shutter can be undertaken directly using ETS parameters.

Example

The first three outputs of the device are assigned to the following scenes. The preset values have been saved with the last corresponding setting of the scenes.

Output	Scene No.	Preset position	Preset slat
A	5	20 %	50 %
A	9	47 %	30 %
A	45	70 %	80 %
B	5	20 %	50 %
B	37	82 %	65 %
B	45	75 %	31 %
B	58	65 %	77 %
C	10	80 %	-

If scene No. 5 is now recalled, the blinds/shutters on outputs A and B will move to the saved preset positions and align their slats in accordance with the saved preset value. The blind/shutter on output C is not assigned to scene No. 5 and will therefore not move.

If, however, scene No. 10 is recalled, only the blind/shutter on output C will move to the saved preset position. As output C in this example is operated in the *Control without slat adjustment* (shutter) operation mode, the subsequent alignment of the slats is not undertaken.

If the output A was most recently moved to the 20 % / 50 % position using the telegram *Recall scene no. 5* and the user now wishes to apply this position as the new specified value for scene no. 45, then the number 45 and the request *Save scene* is sent via KNX at the touch of a button. The blind/shutter does not move. The current position is saved as the now specified value for scene no. 45 (see table below) and is moved to then next time this scene is recalled.

Output	Scene No.	Preset position	Preset slat
A	5	20 %	50 %
A	9	47 %	30 %
A	45	20 %	50 %

The 8-bit scene offers a few advantages in comparison to conventional scene programming.

When calling a scene, a single telegram is sent on the bus and is received by all participants in the scene and implemented accordingly. The target position is saved in the device and does not need to be transferred via the KNX with each recall. Only one group address is required for up to 64 scenes. This simplifies the engineering involved and reduces the bus load.

Reaction on bus voltage failure and programming

If there is a bus voltage failure, the saved scene values are retained, as is the case when only the parameters are loaded during programming. The scene value is reset to the position *Very top*, i.e. the position specification = 0 % and slat specification = 0 %, when

- The device is discharged and reprogrammed.
- The application version changes.

4.5 Reaction on bus voltage failure

The reaction on bus voltage failure can be parameterized in the parameter window *A: General* via the parameter *Reaction on bus voltage failure* for each individual output. This parameterization has a direct impact on the output contacts and has the highest priority.

Should a bus voltage failure occur during a movement, then the blind/shutter can still move in the opposite direction.

After the contact positions on bus voltage failure have been set, the JRA/S cannot function until bus voltage recovery.

4.6 Reaction on bus voltage recovery, download and ETS reset

The reaction on bus voltage recovery can be parameterized for each output. The device is ready for operation after an initialization time of a few seconds after applying the bus voltage. Depending on the time set in the *General* parameter window for *Time-delayed switching of drives* and the *Sending and switching delay time on bus voltage recovery in s [2...255]*, the individual outputs assume the parameterized position after the initialization time.

After programming or an ETS reset, all the communication objects assume the value 0 (exception: End positions = 1).

After programming, all the positions are invalid or deleted. After bus voltage recovery, programming or an ETS reset, the blind/shutter is moved to the parameterized position and/or automatic sun protection activated. If the option *Position X* or *Individual position* is set as the position after programming, then the blind/shutter is moved along the shortest route to the target position via an end position to determine the current position. After the movement has been completed, the status communication objects are updated and send their value.

What is an ETS reset?

Generally an ETS reset is defined as a reset of the device via the ETS. The ETS Reset is triggered in the ETS under the menu item *Commissioning* with the function *Reset device*. This stops and restarts the application.

ABB i-bus® KNX

Planning and application

Function	Reaction on		
	Bus voltage recovery	Download	ETS reset
Output/contact position	Depending on the setting of the parameter <i>Reaction after bus voltage recovery</i>	Depending on the setting of the parameter <i>Reaction after download or ETS reset</i>	
Travel times (via travel detection)	Values remain intact	Communication object values remain intact, according to the setting of the parameter <i>Delete saved travel times after download</i> or are overwritten with the default settings (60 s for UP or DOWN)	Travel times are overwritten with default settings (60 s for UP or DOWN).
Weather alarms	Communication object values are reset. Monitoring times are restarted		
Positions 1...4 (Presets)	Values are retained	Positions are backed up, depending on the setting of the parameter <i>Overwrite position values (presets) on download</i> or are overwritten with the parameterized values	Values of the communication objects are reset
Scene	Scene settings remain intact. Communication object value is reset	Scene settings are backed up, depending on the setting of the parameter <i>Overwrite scenes on download</i> or are overwritten with the parameterized values	Scene settings and value of the communication object are reset
Automatic sun protection	Depending on the setting of the parameter <i>Reaction after bus voltage recovery</i>	Depending on the setting of the parameter <i>Reaction after programming or ETS reset</i>	
Status messages	Values sent after output update, if parameterized		
Manual operation	Depending on the setting of the parameter <i>Manual operation after bus voltage recovery, programming and ETS reset</i>		

A **Appendix**

A.1 **Scope of delivery**

The ABB i-bus® KNX Blind / Roller Shutter Actuator JRA/S is supplied with the following components.
Please check the items received using the following list.

- 1x JRAS/S x.y.z.1, MDRC
- 1x label carrier
- 1 x installation and operating instructions
- 1 x bus connection terminal (red/black)

A.2 Code table Scene (8 bit), DPT 18.001

The following table indicates the telegram code for an 8-bit scene in hexadecimal and binary code for the 64 scenes. Normally when retrieving or storing a scene, an 8-bit value must be sent.

Bit no.	7	6	5	4	3	2	1	0			
8-bit value	Hexadecimal	Recall 0 Save 1	Not defined	Binary number codes	Binary number codes	Binary number codes	Binary number codes	Binary number codes	Scene number	Recall A Save S	No reaction -
0	00	0							1	A	
1	01	0						■	2	A	
2	02	0						■	3	A	
3	03	0						■	4	A	
4	04	0						■	5	A	
5	05	0						■	6	A	
6	06	0						■	7	A	
7	07	0						■	8	A	
8	08	0						■	9	A	
9	09	0						■	10	A	
10	0A	0						■	11	A	
11	0B	0						■	12	A	
12	0C	0						■	13	A	
13	0D	0						■	14	A	
14	0E	0						■	15	A	
15	0F	0						■	16	A	
16	10	0						■	17	A	
17	11	0						■	18	A	
18	12	0						■	19	A	
19	13	0						■	20	A	
20	14	0						■	21	A	
21	15	0						■	22	A	
22	16	0						■	23	A	
23	17	0						■	24	A	
24	18	0						■	25	A	
25	19	0						■	26	A	
26	1A	0						■	27	A	
27	1B	0						■	28	A	
28	1C	0						■	29	A	
29	1D	0						■	30	A	
30	1E	0						■	31	A	
31	1F	0						■	32	A	
32	20	0						■	33	A	
33	21	0						■	34	A	
34	22	0						■	35	A	
35	23	0						■	36	A	
36	24	0						■	37	A	
37	25	0						■	38	A	
38	26	0						■	39	A	
39	27	0						■	40	A	
40	28	0						■	41	A	
41	29	0						■	42	A	
42	2A	0						■	43	A	
43	2B	0						■	44	A	
44	2C	0						■	45	A	
45	2D	0						■	46	A	
46	2E	0						■	47	A	
47	2F	0						■	48	A	
48	30	0						■	49	A	
49	31	0						■	50	A	
50	32	0						■	51	A	
51	33	0						■	52	A	
52	34	0						■	53	A	
53	35	0						■	54	A	
54	36	0						■	55	A	
55	37	0						■	56	A	
56	38	0						■	57	A	
57	39	0						■	58	A	
58	3A	0						■	59	A	
59	3B	0						■	60	A	
60	3C	0						■	61	A	
61	3D	0						■	62	A	
62	3E	0						■	63	A	
63	3F	0						■	64	A	

Empty = Value 0
■ = Value 1, applicable

Bit No.	7	6	5	4	3	2	1	0			
8-bit value	Hexadecimal	Recall 0 Save 1	Not defined	Binary number codes	Binary number codes	Binary number codes	Binary number codes	Binary number codes	Scene number	Recall A Save S	No reaction -
128	80	1							1	∅	
129	81	1						■	2	∅	
130	82	1						■	3	∅	
131	83	1						■	4	∅	
132	84	1						■	5	∅	
133	85	1						■	6	∅	
134	86	1						■	7	∅	
135	87	1						■	8	∅	
136	88	1						■	9	∅	
137	89	1						■	10	∅	
138	8A	1						■	11	S	
139	8B	1						■	12	S	
140	8C	1						■	13	S	
141	8D	1						■	14	S	
142	8E	1						■	15	S	
143	8F	1						■	16	S	
144	90	1						■	17	S	
145	91	1						■	18	S	
146	92	1						■	19	S	
147	93	1						■	20	S	
148	94	1						■	21	S	
149	95	1						■	22	S	
150	96	1						■	23	S	
151	97	1						■	24	S	
152	98	1						■	25	S	
153	99	1						■	26	∅	
154	9A	1						■	27	∅	
155	9B	1						■	28	∅	
156	9C	1						■	29	S	
157	9D	1						■	30	S	
158	9E	1						■	31	S	
159	9F	1						■	32	S	
160	A0	1						■	33	S	
161	A1	1						■	34	S	
162	A2	1						■	35	S	
163	A3	1						■	36	S	
164	A4	1						■	37	S	
165	A5	1						■	38	S	
166	A6	1						■	39	S	
167	A7	1						■	40	S	
168	A8	1						■	41	S	
169	A9	1						■	42	S	
170	AA	1						■	43	S	
171	AB	1						■	44	S	
172	AC	1						■	45	S	
173	AD	1						■	46	S	
174	AE	1						■	47	S	
175	AF	1						■	48	S	
176	B0	1						■	49	S	
177	B1	1						■	50	S	
178	B2	1						■	51	S	
179	B3	1						■	52	∅	
180	B4	1						■	53	∅	
181	B5	1						■	54	∅	
182	B6	1						■	55	∅	
183	B7	1						■	56	∅	
184	B8	1						■	57	S	
185	B9	1						■	58	S	
186	BA	1						■	59	S	
187	BB	1						■	60	S	
188	BC	1						■	61	S	
189	BD	1						■	62	S	
190	BE	1						■	63	S	
191	BF	1						■	64	S	

A.3 Code table for communication object *Status information (Bit 0...7)*

The 2-byte communication object *Status information* makes information on the operating state of the output and connected drives available. The communication object *Status information* can be sent to the KNX via the inter-device communication object *Request status values*.

For further information, see: Communication object no. 39 ff and No. 1.

The communication object Status information is divided up into two 1-byte values:

Bit 0...7 = Low Byte

Bit 8...15 = High Byte

The Low Byte shows the operating states of the output. Only one operating state can ever be active (1 n)

In the High Byte, additional status information on the output is made available. Multiple items of information may be active simultaneously.

Low Byte code table; Operation mode *Control with slat adjustment*

Bit no.	7	6	5	4	3	2	1	0		
Status byte value (decimal)										
Status byte value (hexadecimal)										
Automatic heating/cooling										
Automatic sun protection										
Wind alarm										
Rain alarm										
Frost alarm										
Forced operation										
Block										
Manual operation										
Current status										
Operation										
0	00								Direct positioning	Via CO - Up/down - Stop/slat adj. - Move to position - Scene
1	01							■	Manual operation	Using the Up/Down buttons
2	02							■	Block	Disabled
4	04							■	Forced operation	Disabled
8	08							■	Frost alarm	Disabled
16	10							■	Rain alarm	Disabled
32	20							■	Wind alarm	Disabled
64	40							■	Automatic sun protection	Via communication objects: - Sun - Sun position - Sun slat
128	80							■	Automatic heating/cooling	Via communication objects: - Heating - Cooling
Other	Other	-	-	-	-	-	-	-	Not defined	

Empty = Value 0

■ = Value 1, applicable

A.4 Order details

Device type	Product Name	Order No.	bbn 40 16779 EAN	Price group	Weight 1 pc. [kg]	Packaging [pcs.]
JRA/S 2.230.5.1	Blind / Roller Shutter Actuator with Travel Detection and Manual Operation, 2-fold, 230 V AC, MDRC	2CDG 110 124 R0011	698436	P2	0.2	1
JRA/S 4.230.5.1	Blind / Roller Shutter Actuator with Travel Detection and Manual Operation, 4-fold, 230 V AC, MDRC	2CDG 110 125 R0011	698443	P2	0.25	1
JRA/S 8.230.5.1	Blind / Roller Shutter Actuator with Travel Detection and Manual Operation, 8-fold, 230 V AC, MDRC	2CDG 110 126 R0011	698450	P2	0.45	1
JRA/S 4.24.5.1	Blind / Roller Shutter Actuator with Travel Detection and Manual Operation, 4-fold, 24 V DC, MDRC	2CDG 110 128 R0011	698474	P2	0.25	1
JRA/S 2.230.2.1	Blind / Roller Shutter Actuator with Manual Operation, 2-fold, 230 V AC, MDRC	2CDG 110 120 R0011	698399	P2	0.2	1
JRA/S 4.230.2.1	Blind / Roller Shutter Actuator with Manual Operation, 4-fold, 230 V AC, MDRC	2CDG 110 121 R0011	698405	P2	0.25	1
JRA/S 8.230.2.1	Blind / Roller Shutter Actuator with Manual Operation, 8-fold, 230 V AC, MDRC	2CDG 110 122 R0011	698412	P2	0.45	1
JRA/S 2.230.1.1	Blind / Roller Shutter Actuator, 2-fold, 230 V AC, MDRC	2CDG 110 129 R0011	698481	P2	0.2	1
JRA/S 4.230.1.1	Blind / Roller Shutter Actuator, 4-fold, 230 V AC, MDRC	2CDG 110 130 R0011	698498	P2	0.25	1
JRA/S 8.230.1.1	Blind / Roller Shutter Actuator, 8-fold, 230 V AC, MDRC	2CDG 110 131 R0011	698504	P2	0.45	1

ABB i-bus[®] KNX Appendix

A.5 Notes

Notes

Notes

Contact us

ABB STOTZ-KONTAKT GmbH

Eppelheimer Strasse 82

69123 Heidelberg, Germany

Phone: +49 (0)6221 701 607

Fax: +49 (0)6221 701 724

e-mail: knx.marketing@de.abb.com

Further information and local contacts:

www.abb.com/knx

Note:

We reserve the right to make technical changes or modify the contents of this document without prior notice.

The agreed properties are definitive for any orders placed. ABB AG shall not be liable for any consequences arising from errors or incomplete information in this document.

We reserve all rights in this document and in the subject matter and illustrations contained therein. Reproduction, transfer to third parties or processing of the content – including sections thereof – is not permitted without prior expressed written permission from ABB AG.

Copyright© 2024 ABB

All rights reserved