



ABB i-bus[®] KNX Blower Actuator FCL/S x.6.1.1 Product Manual

Contents

Page

1	General	3
1.1	Using the product manual.....	3
1.1.1	Notes	4
1.2	Product and functional overview.....	5
2	Device technology	7
2.1	FCL/S x.6.1.1 Blower Actuator x-fold, 6 A, MDRC.....	7
2.1.1	Technical data	7
2.1.2	Lamp output load at 230 V AC	10
2.1.3	Connection diagrams.....	11
2.1.4	Dimension drawings	12
2.2	Mounting and installation.....	13
3	Start-up	15
3.1	Overview.....	15
3.1.1	Output functions	16
3.2	Parameters.....	17
3.2.1	Parameter window <i>General</i>	18
3.2.2	Parameter window <i>Enable outputs A...F</i>	20
3.2.2.1	Parameter window <i>A: Fan (Multi-level)</i>	21
3.2.2.1.1	Parameter window - <i>Status messages (Multi-level)</i>	25
3.2.2.1.2	Parameter window - <i>Automatic control (Multi-level)</i>	30
3.2.2.1.3	Parameter window - <i>Direct operation</i>	38
3.2.2.1.4	Parameter window - <i>Startup/Run-on</i>	40
3.2.2.2	Parameter window <i>A: Fan (Two-level)</i>	43
3.2.2.3	Parameter window - <i>A: Fan (One-level)</i>	44
3.2.2.3.1	Parameter window - <i>Status messages (One-level)</i>	47
3.2.2.3.2	Parameter window - <i>Automatic control (One-level)</i>	49
3.2.2.4	Parameter window <i>B: Output</i>	55
3.2.2.4.1	Parameter window <i>B: Output - Time</i>	58
3.2.3	Commissioning without bus voltage	62
3.3	Communication objects	63
3.3.1	Summary of communication objects.....	63
3.3.2	Communication objects <i>General</i>	66
3.3.3	Communication objects <i>Fan A and Fan CDE</i>	67
3.3.3.1	Communication objects <i>Fan Multi-level</i>	67
3.3.3.2	Communication objects <i>Fan One-level</i>	73
3.3.4	Communication objects <i>Output</i>	78

ABB i-bus[®] KNX

Contents

4	Planning and application	81
4.1	Fan output.....	81
4.1.1	Fan operation.....	82
4.1.1.1	Fan with changeover switch.....	83
4.1.1.2	Fan with step switch.....	83
4.1.2	Automatic control.....	84
4.1.3	Direct operation.....	86
4.1.4	Switchover between automatic and direct operation.....	86
4.1.5	Speed switching logic.....	87
4.1.6	Fan operation functional diagram.....	88
4.2	Switch output.....	89
4.2.1	Function diagram.....	89
4.2.2	<i>Time</i> function.....	90
4.2.2.1	Staircase lighting.....	90
4.3	Application example: Switching heating and cooling valves.....	91
4.4	Reaction on bus voltage failure, recovery, download and ETS reset.....	92
4.4.1	Bus voltage recovery.....	92
4.4.2	Bus voltage recovery.....	92
4.4.3	ETS reset.....	93
4.4.4	Download.....	93
4.4.5	Tabular overview of bus voltage recovery, download and ETS reset.....	94
4.5	Priorities.....	95
A	Appendix	97
A.1	Scope of delivery.....	97
A.2	Fan status byte, forced/operation.....	98
A.3	Ordering details.....	99
A.4	Notes.....	100

1 General

The Blower Actuator FCL/S x.6.1.1 is used in ventilation applications.

It is a compact device that serves the following functions:

- Controlling fans and blowers
- Switching loads

Outputs that are not being used for fan functions can be used as switch actuators for switching electrical loads.

1.1 Using the product manual

This manual provides detailed technical information on the function, installation and programming of the ABB i-bus[®] KNX device.

This manual is divided into the following chapters:

Chapter 1	General
Chapter 2	Device technology
Chapter 3	Start-up
Chapter 4	Planning and application
Chapter A	Appendix

1.1.1

Notes

Notes and safety instructions are represented as follows in this manual:

Note
Tips for usage and operation

Examples
Application examples, installation examples, programming examples

Important
These safety instructions are used as soon as there is danger of a malfunction without risk of damage or injury.

Caution
These safety instructions are used as soon as there is danger of a malfunction without risk of damage or injury.

 Danger
These safety instructions are used if there is a danger to life and limb with inappropriate use.

 Danger
These safety instructions are used if there is an extreme danger to life with inappropriate use.

1.2 Product and functional overview

The FCL/S 1.6.1.1 and FCL/S 2.6.1.1 Blower Actuators are modular installation devices in ProM design 4- and 8-module widths for installation in a distribution board. Connection to the ABB i-bus KNX is established via the front bus connection terminal. The devices require no auxiliary voltage. The assignment of physical addresses as well as the parameterization is carried out with Engineering Tool Software ETS.

The FCL/S 1.6.1.1 1-fold actuator controls a single-phase fan with up to three fan speeds via a step or changeover control. The FCL/S 2.6.1.1 2-fold actuator can control a second fan. The actuators ensure that no two fan speeds can be switched on simultaneously.

The outputs on the 2-fold actuator that are not used for the fan can be used to switch electrical loads.

The device receives its control value via the ABB i-bus[®] KNX, e.g. from a room thermostat.

The following controls are feasible:

FCL/S 1.6.1.1:

- One 3-speed fan plus one switch output

FCL/S 2.6.1.1:

- Two 3-speed fans plus two switching outputs
- One 3-speed fan plus five switching outputs

ABB i-bus® KNX Device technology

2 Device technology

2.1 FCL/S x.6.1.1 Blower Actuator x-fold, 6 A, MDRC



FCL/S 2.6.1.1

2CDC071026S0012

The FCL/S x.6.1.1 Blower Actuator is a modular installation device (MDRC) in ProM design. It is intended for installation in the distribution board on 35 mm mounting rails. The assignment of the physical address as well as the parameterization is carried out using ETS and the current application.

The device is powered via the ABB i-bus® KNX and requires no additional auxiliary voltage supply. The device is ready for operation after connecting the bus voltage.

2.1.1 Technical data

Power supply	KNX bus voltage	21...32 V DC	
	Current consumption, bus	< 12 mA	
	Power consumption	Maximum 250 mW	
Rated output value	FCL/S Type	1.6.1.1	2.6.1.1
	Number	4	8
	U _n rated voltage	250/440 V AC (50/60 Hz)	
	I _n rated current (per output)	6 A	6 A
	Leakage loss per device at max. load	1.5 W	2.0 W
Output switching current	AC3 ²⁾ operation (cos φ = 0.45) To EN 60 947-4-1	6 A/230 V AC	
	AC1 ²⁾ operation (cos φ = 0.8) To EN 60 947-4-1	6 A/230 V AC	
	Fluorescent lighting load to EN 60 669-1	6 A/250 V AC (35 μF) ¹⁾	
	Minimum switching capacity	20 mA/5 V AC	
		10 mA/12 V AC	
Output service life	Mechanical service life	> 10 ⁷	
	Electronic endurance to IEC 60 947-4-1		
	AC1 ²⁾ (240 V/cos φ = 0.8)	> 10 ⁵	
	AC3 ²⁾ (240 V/cos φ = 0.45)	> 1.5 x 10 ⁴	
	AC5a ²⁾ (240 V/cos φ = 0.45)	> 1.5 x 10 ⁴	

¹⁾ The maximum inrush current peak may not be exceeded.

2) What do the terms AC1, AC3 and AC5a mean?

In Intelligent Building Control, different switching capabilities and performance specifications, required by special applications, have become established in industrial and residential systems. These performance specifications are rooted in the respective national and international standards. The tests are defined to simulate typical applications, e.g. motor loads (industrial) or fluorescent lamps (residential).

Specifications AC1 and AC3 are switching performance specifications which have become established in the industrial field.

Typical application:

AC1 – Non-inductive or slightly inductive loads, resistive furnaces (relates to switching of ohmic/resistive loads)

AC3 – Squirrel-cage motors: Starting, switching off motors during running (relates to (inductive) motor load)

AC5a – Switching of electric discharge lamps

These switching performances are defined in standard EN 60 947-4-1 *Contactors and motor-starters – Electromechanical contactors and motor-starters*. The standard describes starters and/or contactors that were originally used primarily in industrial applications.

ABB i-bus[®] KNX

Device technology

Output switching times³⁾	Maximum output relay position change per minute if all relays are switched simultaneously. The position changes should be distributed equally within the minute. Maximum output relay position change per minute if only one relay is switched.	1.6.1.1 60 240	2.6.1.1 30 240
Connections	KNX Load circuits Tightening torque	Via bus connection terminals, 0.8 mm Ø, solid Screw terminal 0.2...2.5 mm ² fine stranded 0.2...4 mm ² solid max. 0.6 Nm	
Operating and display elements	<i>Programming</i> Button/LED	For assignment of the physical address	
Degree of protection	IP 20	To EN 60 529	
Protection class	II	To EN 61 140	
Isolation category	Overvoltage category Pollution degree	III to EN 60 664-1 2 to EN 60 664-1	
KNX safety extra low voltage	SELV 24 V DC		
Temperature range	Operation Storage Transport	-5 °C...+45 °C -25 °C...+55 °C -25 °C...+70 °C	
Ambient conditions	Maximum air humidity	95 %, no condensation allowed	
Design	Modular installation device (MDRC) FCL/S Type Dimensions Width W in mm Mounting width in units (18 mm modules) Mounting depth in mm	Modular installation device, ProM 1.6.1.1 2.6.1.1 90 x W x 64.5 mm (H x W x D) 72 108 4 6 64.5 64.5	
Weight		1.6.1.1	2.6.1.1
	in kg	0.13	0.24
Installation	On 35 mm mounting rail	To EN 60 715	
Mounting position	As required		
Housing/color	Plastic housing, gray		
Approvals	KNX to EN 50 090-1, -2	Certification	
CE mark	In accordance with the EMC guideline and low voltage guideline		

³⁾ The specifications apply only after the bus voltage has been applied to the device for at least 30 seconds. Typical relay delay is approx. 20 ms.

ABB i-bus[®] KNX Device technology

2.1.2 Lamp output load at 230 V AC

Lamps	Incandescent lamp load	1200 W
Fluorescent lamps T5/T8	Uncorrected	800 W
	Parallel compensated	300 W
	DUO circuit	350 W
Low-voltage halogen lamps	Inductive transformer	800 W
	Electronic transformer	1000 W
	Halogen lamps 230 V	1000 W
Dulux lamp	Uncorrected	800 W
	Parallel compensated	800 W
Mercury-vapor lamp	Uncorrected	1000 W
	Parallel compensated	800 W
Switching capacity (switching contact)	Maximum peak inrush current I_p (150 μ s)	200 A
	Maximum peak inrush current I_p (250 μ s)	160 A
	Maximum peak inrush current I_p (600 μ s)	100 A
Number of electronic ballasts (T5/T8, single element)¹⁾	18 W (ABB EVG 1 x 18 SF)	10
	24 W (ABB EVG-T5 1 x 24 CY)	10
	36 W (ABB EVG 1 x 36 CF)	7
	58 W (ABB EVG 1 x 58 CF)	5
	80 W (Helvar EL 1 x 80 SC)	3

¹⁾ For multiple element lamps or other types the number of electronic ballasts must be determined using the peak inrush current of the ballasts.

Device type	Application	Maximum number of Communication objects	Maximum number of group addresses	Maximum number of associations
FCL/S 1.6.1.1	Switch Blower 1f 6A/1.0*	64	254	254
FCL/S 2.6.1.1	Switch Blower 2f 6A/1.0*	124	254	254

* ... = current version number of the application. **Please refer the software information on our homepage for this purpose.**

Note

ETS and the current version of the device application are required for programming. The current version of the application is available for download at www.abb.com/knx. After import into ETS it appears in the *Catalogs* window under *Manufacturers/ABB/Heating, Ventilation, Air conditioning/Ventilation actuator*.

The device does not support the locking function of a KNX device in ETS. If you use a *BCU code* to inhibit access to all the project devices, it has no effect on this device. Data can still be read and programmed.

ABB i-bus® KNX Device technology

2.1.3

Connection diagrams

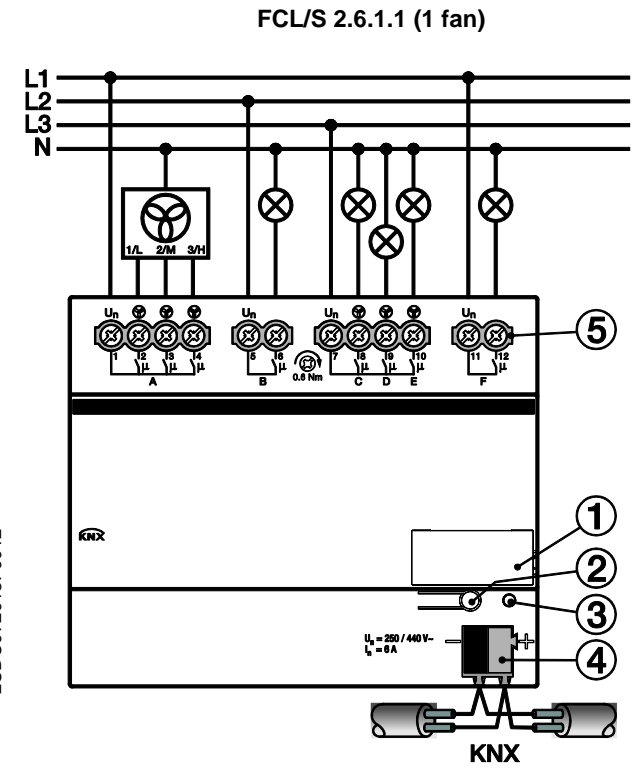
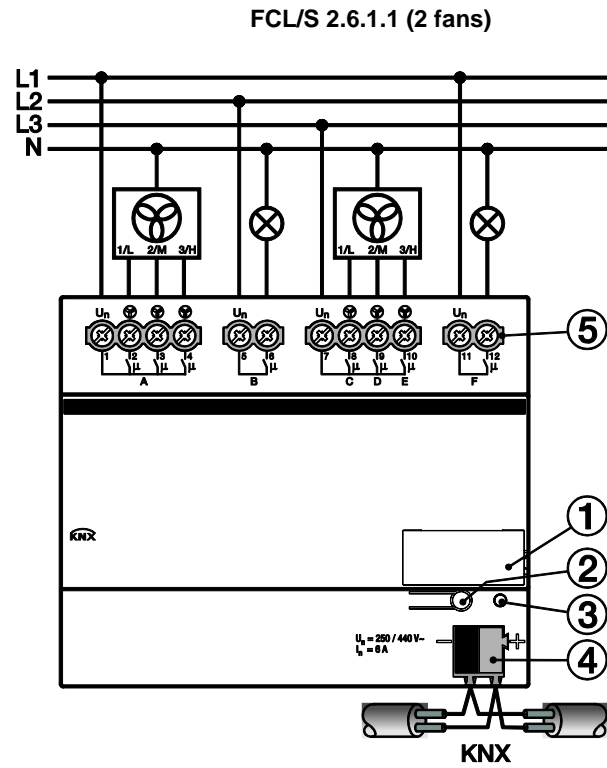
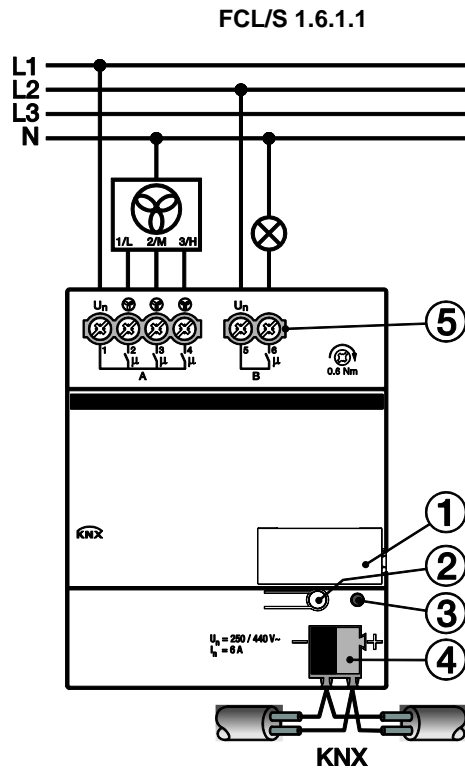

- 1 Label carrier
- 2 Programming button
- 3 Programming LED ● (red)
- 4 Bus connection terminal
- 5 Power outputs

ABB i-bus[®] KNX Device technology

2.1.4

Dimension drawings

FCL/S 1.6.1.1

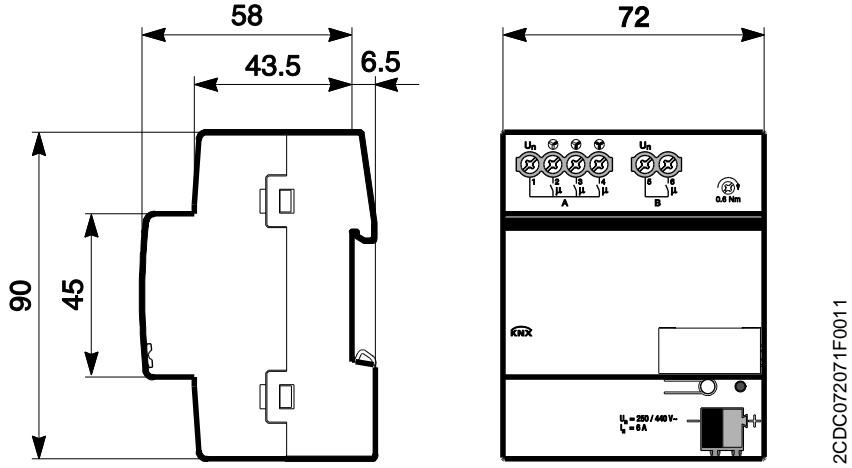

FCL/S 2.6.1.1

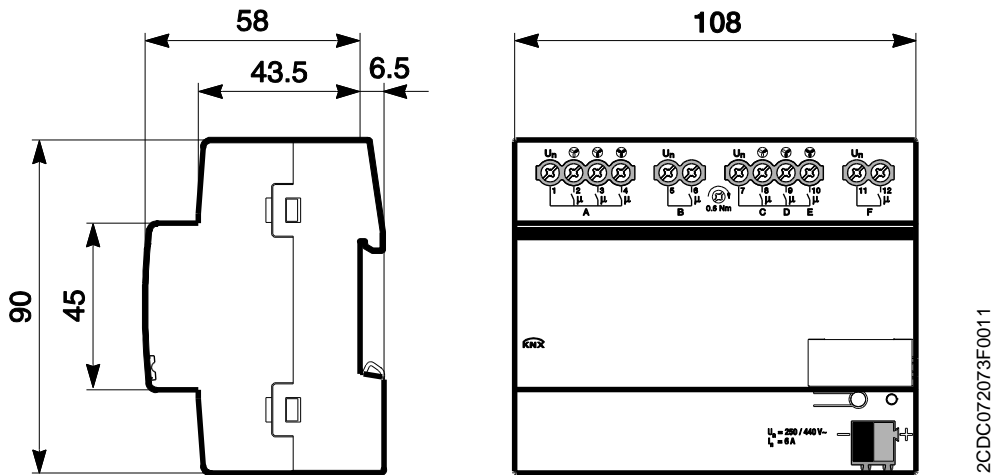

2.2 Mounting and installation

The device is a modular installation device for quick installation in the distribution board on 35 mm mounting rails to EN 60 715.

The mounting position can be selected as required.

The electrical connection is implemented using screw terminals. The connection to the bus is implemented using the supplied bus connection terminal. The terminal assignment is located on the housing.

The device is ready for operation after connection to the bus voltage.

Accessibility of the devices for the purpose of operation, testing, visual inspection, maintenance and repair must be provided compliant to VDE 0100-520.

Commissioning requirements

To commission the device you need a PC with ETS (ETS3 or higher) and an interface (e.g. KNX) to the ABB i-bus[®].

The device is ready for operation after connection to the bus voltage. No additional auxiliary voltage is required.

Important
The maximum permissible current of a KNX line may not be exceeded. During planning and installation ensure that the KNX line is correctly dimensioned. The device features a maximum current consumption of 12 mA (Fan-In 1).

Mounting and commissioning may only be carried out by electrical specialists. The appropriate standards, guidelines, regulations and specifications for your country should be observed when planning and setting up electrical installations and security systems for intrusion and fire detection.

Protect the device from damp, dirt and damage during transport, storage and operation.

Only operate the device within the specified technical data!

The device should only be operated in an enclosed housing (distribution board)!

The voltage supply to the device must be switched off before mounting work is performed.



Danger

To avoid dangerous touch voltages which originate through feedback from differing phase conductors, all poles must be disconnected when extending or modifying the electrical connections.

ABB i-bus[®] KNX

Device technology



Supplied state

The device is supplied with the physical address 15.15.255. The application is pre-installed. It is therefore only necessary to load group addresses and parameters during commissioning.

However, the complete application can be reloaded if required. Downloads may take longer after a change of application or a discharge.

Assignment of the physical address

The assignment and programming of the physical address is carried out in ETS.

The device features a  button for assignment of the physical device address. The red LED  lights up after the button has been pushed. It switches off as soon as ETS has assigned the physical address or the  button is pressed again.

Download response

The progress bar for download may take up to 1.5 minutes to appear depending on the PC that is used, because of the complexity of the device.

Cleaning

If devices become dirty they can be cleaned using a dry cloth or a cloth dampened with a soapy solution. Corrosive agents or solutions should never be used.

Maintenance

The device is maintenance-free. No repairs should be carried out by unauthorized personnel if damage occurs, e.g. during transport and/or storage.

3 Start-up

The blower actuator is parameterized with the *Switch Blower 1f 6A/1.0* (FCL/S 1.6.1.1) or *Switch Blower 2f 6A/1.0* (FCL/S 2.6.1.1) application, and ETS Engineering Tool Software. The application provides the device with a comprehensive and flexible range of functions. The standard settings allow simple commissioning. The functions can be extended if required.

3.1 Overview

The following functions are available:

Fan	A three-speed fan is controlled alternately with a two-way connection or with speed switching.
stagePower outlets (sockets)	For power supply to individual power outlet circuits and other loads.
Illumination	For power supply to individual lighting circuits and other loads.

Caution

Improper switching will destroy the fan motors.
Follow the technical data for the fan, e.g. speed or switching function.
For further information see: [Parameter window A: Fan \(Multi-level\)](#), p.21.

The blower actuator features relays in each output which are mechanically independent of the other outputs. Switching noises cannot be avoided due to the mechanical nature of the design.

The device is installed primarily in the distribution board together with the circuit-breakers and RCCBs.

Usually, the blower actuator is used in conjunction with a room thermostat for an individual room temperature control system. The room thermostat sends a control value which the blower actuator uses to control the fan speeds.

3.1.1 Output functions

The following table provides an overview of the functions possible when you combine the device outputs with the *Switch Blower 1f 6A/1.0* (FCL/S 1.6.1.1) or *Switch Blower 2f 6A/1.0* (FCL/S 2.6.1.1) application.

Output functions	A	B	C, D, E*	F*
Fan	■		■	
NO contact/NC contact		■	■	■
Time				
Staircase lighting		■	■	■

■ = Function is supported

* FCL/S 2.6.1.1 only

Note

Outputs C, D and E can also be programmed as switch actuators. The settings options are described in [Parameter window A: Fan \(Multi-level\)](#), p.21.

3.2 Parameters

ETS Engineering Tool Software is used for parameterizing the device.

In ETS, the application appears in the *Catalogs* window under *Manufacturers/ABB/Heating, Ventilation, Air conditioning/Ventilation actuator*.

The following chapter describes the parameters of the device using the parameter windows. Parameter windows are structured dynamically so that further parameters may be enabled depending on the parameterization and function of the outputs.

The default values of the parameters are underlined, e.g.:

Options: Yes
 No

Note
<p>The FCL/S 1.6.1.1 outputs are:</p> <p>A: Fan output B: Switch actuator output</p> <p>The FCL/S 2.6.1.1 outputs are:</p> <p>A: Fan output B: Switch actuator output C, D, E: One fan output or parameterizable as switch actuators F: Switch actuator output</p>

Note
<p>All parameter window descriptions and control options refer to the FCL/S 2.6.1.1 2-fold Blower Actuator. The application for the FCL/S 1.6.1.1 1-fold Blower Actuator has no <i>Enable outputs A...F</i> parameter window, i.e. output A is always a fan output and the additional switch output B is always activated.</p>

3.2.1 Parameter window *General*

This is the parameter window where you can set higher level parameters.

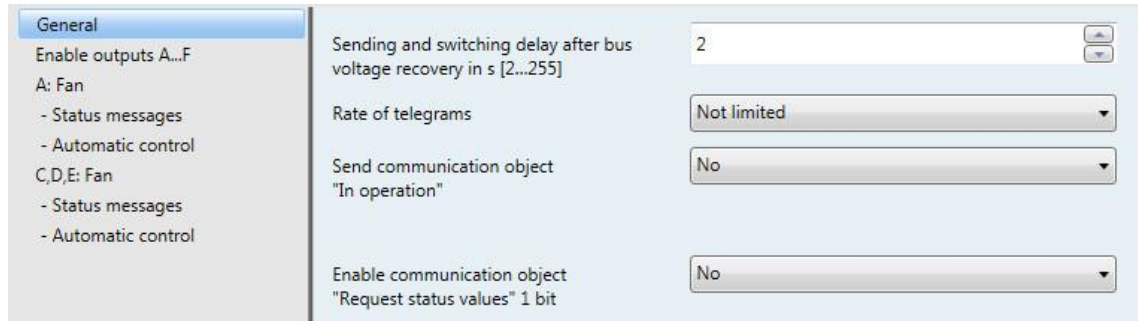

The screenshot shows the 'General' parameter window. On the left is a tree view with the following items: 'General' (selected), 'Enable outputs A...F', 'A: Fan' (with sub-items '- Status messages' and '- Automatic control'), 'C,D,E: Fan' (with sub-items '- Status messages' and '- Automatic control'). The main area contains four parameters:

Sending and switching delay after bus voltage recovery in s [2...255]	2
Rate of telegrams	Not limited
Send communication object "In operation"	No
Enable communication object "Request status values" 1 bit	No

Sending and switching delay after bus voltage recovery in s [2...255]

Options: 2...255

During the sending and switching delay, telegrams are received only. The telegrams are not processed, however, and the outputs remain unchanged. No telegrams are sent via the bus.

After the sending and switching delay, telegrams are sent and the state of the outputs is set to correspond with the parameterization or the communication object values.

If communication objects are read during the sending and switching delay, e.g. by a visualization system, these read requests are stored, and a response is sent, after the sending and switching delay has been completed.

An initialization time of about two seconds is included in the delay time. The initialization time is the time that the processor requires to be ready to function.

How does the device react on bus voltage recovery?

After bus voltage recovery, the device always waits for the transmission delay time to elapse before sending telegrams via the bus.

Rate of telegrams

Options: Not limited
1/2/3/5/10/20 telegram(s)/second
0.05/0.1/0.2/0.3/0.5 seconds/telegram

Using this parameter, the bus load generated by the device can be limited.

- *1/2/3/5/10/20 telegram(s)/second*: X telegrams per second are sent.
- *0.05/0.1/0.2/0.3/0.5 telegram(s)/second*: A telegram is sent every x seconds.

Send communication object "In operation"

Options: No
Send value 0 cyclically
Send value 1 cyclically

The communication object *In Operation* indicates that the device on the bus is working properly. This cyclic telegram can be monitored by an external device.

Note

After bus voltage recovery, the communication object sends its value after the set sending and switching delay.

- *Send value 0 (1) cyclically*: The following parameter appears:

**Telegram is repeated every
in s [1...65,535]**

Options: 1...60...65,535

Here a time interval is set, which the communication object *In operation* uses to cyclically send a telegram.

Enable communication object "Request status values" 1 bit

Options: No
Yes

- Yes: The 1 bit communication object *Request status values* is enabled.

Via this communication object, all status messages can be requested, provided that they have been parameterized with the option *After a change or request*.

With the option Yes, the following parameters appear:

Request with object value

Options: 0
1
0 or 1

- 0: Sending status messages is requested with the value 0.
- 1: Sending status messages is requested with the value 1.
- 0 or 1: Sending status messages is requested with the values 0 or 1.

3.2.2 Parameter window *Enable outputs A...F*

Note

All parameter window descriptions and control options refer to the FCL/S 2.6.1.1 2-fold Blower Actuator. The application for the FCL/S 1.6.1.1 1-fold Blower Actuator has no *Enable outputs A...F* parameter window, i.e. output A is always a fan output and the additional switch output B is always activated.

In this parameter window you can enable outputs A...F.



Output A

Options: Enable as fans

Output A is always enabled as a fan.

Outputs B and F

Options: Enable
Block

- *Block*: output B or F is blocked/hidden. No communication objects are visible.
- *Enabled*: The parameter window *B* or *F: Output* appears. Dependent communication objects become visible.

Outputs C, D, E

Options: Enable as fans
Enable as switch actuators

Outputs C, D and E can be programmed as fans or switch actuators.

- *Enable as fans*: The parameter window *C, D, E: Fan* appears.
- *Enable as switch actuators*: Outputs C, D and E appear as individual parameters and can be enabled individually.

The descriptions of the parameter setting options and the adjustable communication objects for outputs C, D, E are the same as for output A (if enabled as a fan) or B (if enabled as switch actuators), see [Parameter window A: Fan](#), p.21 or [Parameter window B: Output](#), p.55.

3.2.2.1 Parameter window A: Fan (Multi-level)

All settings for output A are made in this parameter window.

These explanations also apply to outputs C, D, E if the parameter *Output C, D, E* in [Parameter window Enable outputs A...F](#), p.20 is set to *Enable as fans*.

All settings for the *Multi-level fan* are made in this parameter window.

General Enable outputs A...F A: Fan - Status messages - Automatic control C,D,E: Fan - Status messages - Automatic control	Fan type Multi-level
	Limit fan speeds to 2 No
	Fan operating mode (note technical data of fan!) Changeover switch
	Delay between speed switchover in ms [50...5,000] 500
	Fan speed on bus voltage failure Unchanged
	Fan speed on bus voltage recovery Unchanged
	Enable communication object "Forced operation" 1 bit No
	Enable automatic operation Yes
	Enable direct operation No
	Set startup/run-on No

Fan type

Option: Multi-level
One-level

This parameter defines the fan type which is to be controlled.

- *Multi-level*: Controls a fan with up to three speeds.
- *One-level*: Controls a fan with one speed.

Limit fan speeds to 2

Option: No
Yes

The fan speeds can be limited to two here. The following settings are the same as those for a three-speed fan, except that they apply only to two speeds.

- *No*: A three-speed fan is controlled.
- *Yes*: A two-speed fan is controlled via fan speeds 1 and 2. Fan speed 3 is non-functional.

Fan operating mode (note technical data of fan!)

Option: Changeover switch
 Step switch

Control of the fan is set with this parameter. The mode of fan control should be taken from the technical data of the fan.

How does changeover switching work?

With changeover switch control, only the corresponding output of the assigned fan speed is switched on.

The delay time between the speed switchover and a minimum dwell time in a fan speed can be parameterized. The latter is only active in automatic operation.

How does step switching work?

With step switch control, it is impossible for the fan to switch on erratically or suddenly. The individual fan speeds are activated consecutively (outputs switched on) until the required fan speed is reached.

The parameterized delay time between two fan speeds has the effect that the current fan speed must be switched on for at least this time before the next speed is switched on. The parameterized minimum dwell time in a fan speed has the same effect as a changeover switch, i.e. it is only active in automatic mode and is added to the switchover delay.

- *Changeover switch*: The following parameter appears:

Delay between speed switchover in ms [50...5,000]

Options: 50...500...5,000

A switchover delay can be programmed with this parameter. This time is a fan-specific factor and it is always taken into account.

Fan speed on bus voltage failure

Option: Unchanged
 OFF

- *Unchanged*: The fan's speeds remain unchanged.
- *OFF*: The fan is switched off.

Fan speed on bus voltage recovery

Options: Unchanged
OFF
1
2
3

- *Unchanged*: The fan's speeds remain unchanged.
- *OFF*: The fan is switched off.
- *1, 2 or 3*: The fan switches to fan speed 1, 2 or 3.

Caution

The device is supplied ex-works with a default setting (factory default). This ensures that the fan setting is switched off when the bus voltage is applied to the relay for the first time, preventing any unintentional switch-on damage to the device during transport, e.g. due to vibration.

It is advisable to apply a bus voltage before connecting the fan, in order to assign it a defined switch state. This eliminates the possibility of an incorrect contact setting destroying the fan.

Enable communication object "Forced operation" 1 bit

Options: No
Yes

- *Yes*: The 1 bit *Forced operation* communication object is enabled. The following parameters appear:

Forced operation on object value

Options: 1
0

- *1*: Forced operation is activated by a telegram with value 1.
- *0*: Forced operation is activated by a telegram with value 0.

Note

During forced operation the settings set in *Automatic control* are ignored. Automatic control is updated after forced operation has been rescinded.

Important

Forced operation remains active until:

- the opposite value is sent;
- the assignment is changed;
- the fan type is changed.

Forced operation is not deactivated by a download of the application, in which the fan type and the respective group addresses are retained.

Forced operation is reset if an ETS reset has occurred.

Limitation on forced operation

Options: 3, 2, 1, OFF
Unchanged
OFF
1
1, OFF
2
2, 1
2, 1, OFF
3
3, 2
3, 2, 1

This parameter sets which fan speed is set, or may not be over/undershot, when forced operation is active.

- 3, 2, 1, OFF: All states are feasible.
- *Unchanged*: The state is retained.
- OFF: Off
- 1: Limited to speed 1.*
- 1, OFF: Limited to speed 1 and off.
- 2: Limited to speed 2.*
- 2, 1: limited to speeds 2 and 1.
- 2, 1, OFF: limited to speeds 2, 1 and off.
- 3: Limited to speed 3.*
- 3, 2: limited to speeds 3 and 2.
- 3, 2, 1: limited to speeds 3, 2 and 1.

* The control value is ignored.

Enable automatic operation

Options: No
Yes

- Yes: *Automatic operation* is enabled, and the [Parameter window - Automatic control \(Multi-level\)](#) on p.30 appears.

Enable direct operation

Options: No
Yes

- Yes: *Direct operation* is enabled and the [Parameter window - Direct operation](#) on p.38 appears.

Set startup/run-on

Options: No
Yes

- Yes: The *Set startup/run-on* function is enabled and the [Parameter window - Startup/Run-on](#) on p.40 appears.

ABB i-bus[®] KNX Start-up

3.2.2.1.1 Parameter window - Status messages (Multi-level)

This is the parameter window where status messages are defined.

This parameter window is always visible for output A. For outputs C, D and E it is visible if the *Outputs C, D, E* parameter in [Parameter window Enable outputs A...F](#) on p.20 is set to *Enable as fans*.

General	Enable communication objects	No
Enable outputs A...F	"Status Fan speed x" 1 bit	
A: Fan	Enable communication object	No
- Status messages	"Status Fan speed" 1 byte	
- Automatic control	Enable communication object	No
C,D,E: Fan	"Status Byte mode" 1 byte	
- Status messages	Enable communication object	No
- Automatic control	"Status Fan On/Off" 1 bit	
	Enable communication object	No
	"Status Automatic" 1 bit	

Enable communication objects "Status Fan speed x" 1 bit

Options: No
Yes

The setting of a fan speed is displayed via these communication objects. You can parameterize whether or not the status of a current or required fan speed is displayed.

- Yes: Three 1 bit communication objects, *Status speed x* ($x = 1...3$) are enabled. The following parameters appear:

Meaning

Options: Current fan speed
Required fan speed

This parameter defines which status – *Current fan speed* or *Required fan speed* – is displayed.

What is current fan speed?

Current fan speed is the speed at which the fan is actually operating.

What is required fan speed?

Required fan speed is the fan speed which has to be reached, e.g. when the transition and dwell times have elapsed.

Note
The limitations are included in this observation, i.e. if a limitation allows only fan speed 2, the fan is operating at fan speed 2, and, for example, a telegram to switch up is received, the required fan speed remains at 2, as fan speed 3 cannot be reached due to the limitation.

Send object values

Options: No, update only
 Only after changing
 After request
 After a change or request

- *No, update only*: The status is updated but not sent.
- *Only after changing*: The status is sent after a change.
- *After request*: The status is sent after a request.
- *After a change or request*: The status is sent after a change or a request.

Enable communication object "Status Fan speed" 1 byte

Options: No
 Yes

This status byte defines the figure value of the fan speed.

This display can be differentiated from *Required fan speed* by selecting *Current fan speed*. Initially, the switchover times, dwell times and start-up phase must be completed before the required fan speed is reached.

- Yes: The communication object *Status Fan speed* is enabled.

What is current fan speed?

The *Current fan speed* is the speed at which the fan is actually operating.

What is required fan speed?

The *Required fan speed* is the fan speed which has to be reached, e.g. when the transition and dwell times have elapsed.

With the option Yes, the following parameters appear:

Meaning

Options: Current fan speed
 Required fan speed

This parameter defines which status – *Current fan speed* or *Required fan speed* – is displayed.

Note
The limitations are included in this observation, i.e. if a limitation allows only fan speed 2, the fan is operating at fan speed 2, and, for example, a telegram to switch up is received, the required fan speed remains at 2, as fan speed 3 cannot be reached due to the limitation.

Send object value

Options: No, update only
 Only after changing
 After request
 After a change or request

- *No, update only*: The status is updated but not sent.
- *Only after changing*: The status is sent after a change.
- *After request*: The status is sent after a request.
- *After a change or request*: The status is sent after a change or a request.

Enable communication object "Status Byte mode" 1 byte

Options: No
 Yes

This status byte indicates the states of Control value selection, Automatic, Forced operation and the four Limitations via a 1 bit coding.

For further information see: [Fan status byte, forced/operation](#), p.98

- Yes: The communication object *Status Byte mode* is enabled. The following parameter appears:

Send object values

Options: No, update only
 Only after changing
 After request
 After a change or request

- *No, update only*: The status is updated but not sent.
- *Only after changing*: The status is sent after a change.
- *After request*: The status is sent after a request.
- *After a change or request*: The status is sent after a change or a request.

Enable communication object "Status Fan On/Off" 1 bit

Options: No
 Yes

The communication object *Status Fan ON/OFF* can be enabled with this parameter.

Some fans initially need an ON telegram before they are set to a fan speed from the OFF state. This ON telegram has effect on a main switch which has to be switched on. This requirement can be implemented with any switch output controlled via the *Status Fan* communication object. The corresponding switch communication object of the switch actuator should be connected with the *Status Fan* communication object.

With the option Yes, the following parameters appear:

Send object value

Options: No, update only
 Only after changing
 After request
 After a change or request

- *No, update only*: The status is updated but not sent.
- *Only after changing*: The status is sent after a change.
- *After request*: The status is sent after a request.
- *After a change or request*: The status is sent after a change or a request.

The following parameter only becomes visible if the *Enable automatic operation* parameter in the *Fan* parameter window is set to Yes.

Enable communication object "Status Automatic" 1 bit

Options: No
 Yes

This parameter enables the communication object *Status Automatic*.

Telegram value 1 = automatic operation active
 0 = automatic operation inactive

- Yes: The following parameter appears:

Send object value

Options: No, update only
 Only after changing
 After request
 After a change or request

- *No, update only*: The status is updated but not sent.
- *Only after changing*: The status is sent after a change.
- *After request*: The status is sent after a request.
- *After a change or request*: The status is sent after a change or a request.

3.2.2.1.2 Parameter window - Automatic control (Multi-level)

This is the parameter window where you define the threshold values for switchover of the fan speed. Limitations can also be enabled here.

This parameter window is visible if the *Enable automatic operation* parameter in [Parameter window A: Fan \(Multi-level\)](#), p.21 is set to Yes.

When automatic operation is enabled, it is active after a download or an ETS reset.

When you activate a communication object in the *Direct operation* parameter window, automatic operation stops immediately. You can only reactivate it via the *Automatic ON/OFF* communication object.

General	Object value "Automatic On/Off" switch on to the automatic	1
Enable outputs A...F	Threshold value OFF <-> speed 1 in % [1...100]	10
A: Fan	Threshold value speed 1 <-> speed 2 in % [1...100]	30
- Status messages	Threshold value speed 2 <-> speed 3 in % [1...100]	70
- Automatic control	Hysteresis threshold value in % +/- [0...20 %]	5
C,D,E: Fan	Minimum dwell period in fan speed in s [0...65,535]	0
- Status messages	Number of control value inputs	1
- Automatic control	Activate monitoring control values	No
	Enable limitations	No

Important

The device evaluates threshold values in ascending order, i.e. first it checks the threshold value for *Off -> Fan speed 1*, then *Fan speed 1 -> Fan speed 2*, and so on.

Proper functionality is only assured if the threshold value for *OFF -> Fan speed 1* is less than that for *Fan speed 1 -> Fan speed 2* and this is less than *Fan speed 2 -> Fan speed 3*, etc.

Object value "Automatic On/Off" switch on to the automatic

Options: $\frac{1}{0}$

This parameter defines how to react to a telegram.

- 1: Automatic is activated by a telegram with value 1.
- 0: Automatic is activated by a telegram with value 0.

Threshold value OFF <-> speed 1 in % [1...100]

Options: 1...10...100

This sets the threshold value at which fan speed 1 switches on. If the value in the control value communication object is greater than or equal to the parameterized threshold value, fan speed 1 switches on; otherwise (if less) it switches off.

Threshold value speed 1 <-> speed 2 in % [1...100]

Options: 1...30...100

This sets the threshold value at which switchover to fan speed 2 occurs. If the value in the control value communication object is greater than or equal to the parameterized threshold value, switchover to fan speed 2 occurs.

Threshold value speed 2 <-> speed 3 in % [1...100]

Options: 1...70...100

This sets the threshold value at which switchover to fan speed 3 occurs. If the value in the control value communication object is greater than or equal to the parameterized threshold value, switchover to fan speed 3 occurs.

Hysteresis threshold value in % +/- [0...20 %]

Options: 0...5...20

This sets a hysteresis at which switchover to the next fan speed occurs. The hysteresis applies for all three threshold values.

The setting 0 causes immediate switching without hysteresis.

The entered percentage value is directly added to or subtracted from the percentage value of *Threshold value speed x*. The result is a new upper or lower threshold value.

Switch threshold top (switch on) = threshold value + hysteresis

Switch threshold bottom (switch off) = threshold value - hysteresis

Example: Three-speed fan, fan control with hysteresis

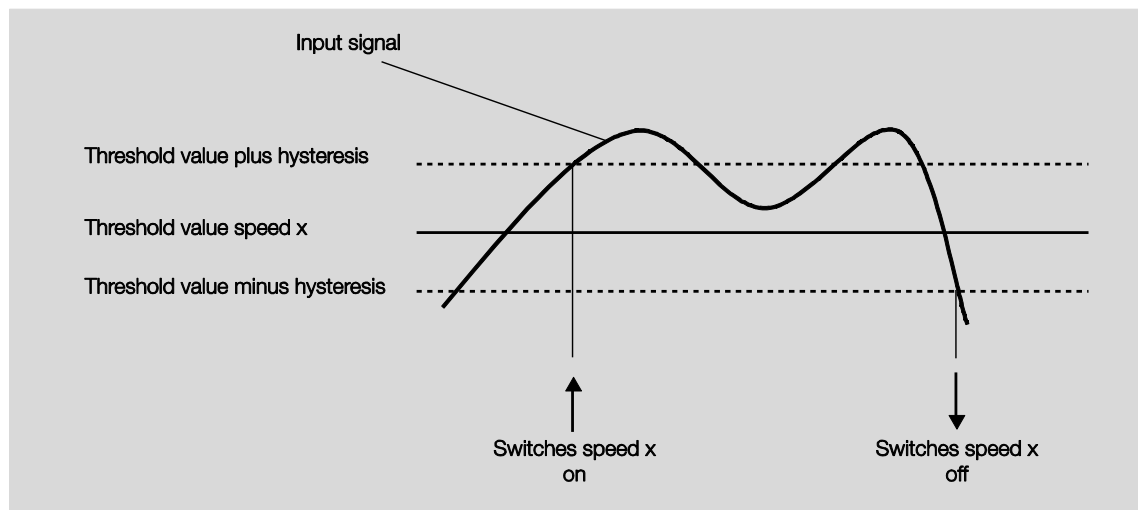

Using hysteresis avoids continual switching between the fan speeds caused by fluctuating input signals around the threshold value.

Important

How does the fan react if the switch thresholds overlap as a result of using hysteresis?

- 1) Hysteresis defines the speed at which the speed change occurs.
 - 2) If the speed transition occurs, the new speed is determined using the control value and the set switch thresholds. The hysteresis is not taken into account.
- Control values are rounded to whole percentages by the device.
- 3) A control variable with the value 0 always results in speed 0.

An example:

Parameterized: Threshold value OFF <-> speed 1 = 10 %

Threshold value speed 1 <-> speed 2 = 20 %

Threshold value speed 2 <-> speed 3 = 30 %

Hysteresis 15 %

Behavior when ascending from speed 0:

- Speed 0 transition at 25 % ($\geq 10 \% + \text{hysteresis}$).
- The new speed is 2 (25 % is between 20 % and 30 %).
- Accordingly, speed 1 is omitted.

Behavior when descending from speed 3:

- Speed 3 transition at 14 % ($< 30 \% - \text{hysteresis}$).
- The new speed is 1 (15 % is between 10 % and 20 %).
- Accordingly, speed 2 is omitted.

Minimum dwell period in fan speed in s [0...65,535]

Options: 0...30...65,535

This parameter defines the dwell time for a fan speed until the fan switches to the next higher or lower speed. The input is made in seconds.

A setting of 0 means instantswitching. Minimum relay switching times can be found in [Technical data](#), p.7.

The dwell time is only taken into account in automatic operation.

Number of control value inputs

Options: $\frac{1}{2}$

This parameter defines the number of control value inputs (communication objects) for automatic operation.

- 1: There is only one *Control value* communication object.
- 2: There are two communication objects – *Control value A* and *Control value B* – and the following parameter appears:

select by...

Options: Largest value
Communication object "Control value A/B"

This parameter sets how the blower actuator selects which control value (A or B) to use.

- *Largest value*: The largest control value is always selected. If the values are equal (but not zero), the input which was the latest to receive a value is selected.
- *Communication object "Control value A/B"*: The control value to use is selected via the communication object.

Activate monitoring control values

Options: No
Yes

This parameter sets the monitoring for the control value input(s), which detects any missing telegrams on the communication object(s).

- *No*: Control value monitoring is deactivated.
- *Yes*: Control value monitoring is activated.

With the option *Yes*, the following parameters appear:

Monitoring time in s [30...65,535]

Options: 0...120...65,535

This parameter sets the maximum time allowed between two control value telegrams. An error is reported if this time is exceeded.

Note
The monitoring time should be at least twice as long as the cyclical transmission time of the control value, so that the absence of a signal, e.g. due to a high bus load, does not immediately trigger an error.

Where there are two control value inputs, the following additional parameter appears:

Function of monitoring

Options: Monitoring current control values
Monitoring active and inactive control values

This parameter determines the scope of monitoring.

- *Monitoring current control values*: Only the currently selected control value input is monitored for incoming telegram continuity. After a switchover (via *Communication object "Control value A/B"* or *Largest value*), monitoring restarts.
- *Monitoring active and inactive control values*: Both control value inputs are always monitored independently of each other. An error is reported if an object's time is exceeded.

Send object value "Fault control value"

Options: No, update only
 Only after changing
 After request
 After a change or request

- *No, update only*: The status is updated but not sent.
- *Only after changing*: The status is sent after a change.
- *After request*: The status is sent after a request.
- *After a change or request*: The status is sent after a change or a request.

Set control value during fault

Options: No
 Yes

This parameter sets how the output reacts in the event of an error.

- Yes: The following parameter appears:

Control value in % [0...100]

Options: 0...30...100

This parameter sets what percentage to use for the control value in the event of an error.

Enable limitations

Options: No
Yes

- Yes: Four communication objects, *Limitation x*, ($x = 1...4$), are enabled for limitation of the fan speed.

This function defines fan speed ranges (limitations) which may not be over/undershot.

Important

The parameterized start-up behavior which is a technical characteristic of the fan has a higher priority than a limitation, i.e. if a limitation is activated in fan speed 2 and start-up behavior is set at speed 3 then the following behavior will result: The fan is in the OFF state and receives a control signal for fan speed 1. First it goes to speed 3 (start-up speed), then 2, which is specified via the limitation. Due to the limitation, the actual required fan speed 1 will not be reached.

The sequence of the displayed parameters corresponds with their priorities, i.e. the parameter with the highest priority has limitation 1 followed by limitations 2, 3 and 4.

In manual mode limitations are inactive.

The set limitations are reactivated when automatic mode is reactivated.

The following points apply for limitations:

- The limitation need not necessarily apply to one fan speed only. It can also encompass another range of the fan speeds, i.e. only certain fan speeds can be set if the limitation is active. In this way, a limited control is also possible.
- The limitation is activated when a telegram with the value 1 is received on the limitation communication object, and is lifted when the same object receives a telegram with the value 0. A manual action ends automatic control.
- If a limitation is activated, the device switches to the parameterized fan speed regardless of the control value. If another fan speed or a speed outside the "limitation range" is set when the limitation is activated, then the required speed or the limit speed of the range is set.
- When limitations are switched off, fan speed is recalculated and executed. This means that during limitation the device operates normally in the background, the outputs are not changed and implementation only occurs once limitation ends.

Each of the four limitations used to limit the fan speeds has the same parameters.

Important

They are prioritized according to the listed sequence. The highest priority is assigned to limitation 1 and the lowest to limitation 4.

Fan speed with limitation 1
Fan speed with limitation 2
Fan speed with limitation 3
Fan speed with limitation 4

Options: 3, 2, 1, OFF
Unchanged
OFF
1
1, OFF
2
2, 1
2, 1, OFF
3
3, 2
3, 2, 1

This parameter sets the fan speed or speed range that applies under active limitation.

- **3, 2, 1, OFF:** All states are possible.
- **Unchanged:** The state is retained.
- **OFF:** Off
- **1:** Limited to speed 1.*
- **1, OFF:** Limited to speed 1 and off.
- **2:** Limited to speed 2.*
- **2, 1:** limited to speeds 2 and 1.
- **2, 1, OFF:** limited to speeds 2, 1 and off.
- **3:** Limited to speed 3.*
- **3, 2:** limited to speeds 3 and 2.
- **3, 2, 1:** limited to speeds 3, 2 and 1.

* The control value is ignored.

3.2.2.1.3 Parameter window - Direct operation

This parameter window is visible if the *Enable direct operation* parameter in [Parameter window A: Fan \(Multi-level\)](#), p.21 is set to *Yes*.

The screenshot shows a software interface with a left-hand menu and a main content area. The menu includes 'General', 'Enable outputs A...F', 'A: Fan', '- Status messages', '- Automatic control', '- Direct operation' (highlighted), 'C,D,E: Fan', '- Status messages', and '- Automatic control'. The main content area has three rows, each with a label and a dropdown menu:

Enable communication objects "Switch speed x" 1 bit	Yes
Enable communication object "Fan speed up/down" 1 bit	No
Enable communication object "Fan speed switch" 1 byte	No

Enable communication objects "Switch speed x" 1 bit

Options: No
 Yes

- Yes: Three 1 bit communication objects, *Switch speed x* ($x = 1...3$) are enabled.

The device receives a setting telegram via these communication objects.

Telegram value 1 = Fan speed x is switched on
 0 = fan speed x is switched off

If several ON/OFF telegrams are received consecutively in a short period of time at various *Fan speed 1...3* communication objects, the value last received will be the one used to control the fan. An OFF telegram to one of the three communication objects *Fan speed 1...3* switches the fan off.

Important

Forced operation remains valid and is taken into account.

The parameterized minimum fan speed dwell time for automatic operation is ignored during manual operation. Accordingly, an immediate reaction to manual operation is detected.

The delay time with speed switchover remains active to protect the fan.

Enable communication object "Fan speed up/down" 1 bit

Options: No
 Yes

- Yes: A 1 bit *Fan speed up/down* communication object is enabled.

Telegram value 1 = a fan speed is switched UP
 0 = a fan speed is switched DOWN

If the maximum fan speed is reached and a further telegram with the value 1 is received, the speed will remain as it is.

Important

Forced operation remains valid and is taken into account.

The parameterized minimum fan speed dwell time for automatic control is ignored during manual operation. Accordingly, an immediate reaction to manual operation is detected.

The delay time with speed switchover remains active to protect the fan.

With multiple manual UP or DOWN switching, the required speed will be increased or reduced by a speed step. This is feasible until the maximum or minimum possible speed is reached. Further UP or DOWN telegrams are ignored and not executed. Each new switching telegram initiates a recalculation of the required speed.

Enable communication object "Fan speed switch" 1 byte

Options: No
 Yes

- Yes: A 1 byte communication object *Fan speed switch* is enabled.

3.2.2.1.4 Parameter window - Startup/Run-on

This parameter window is visible if the *Startup/Run-on* parameter in [Parameter window A: Fan \(Multi-level\)](#), p.21 is set to Yes.

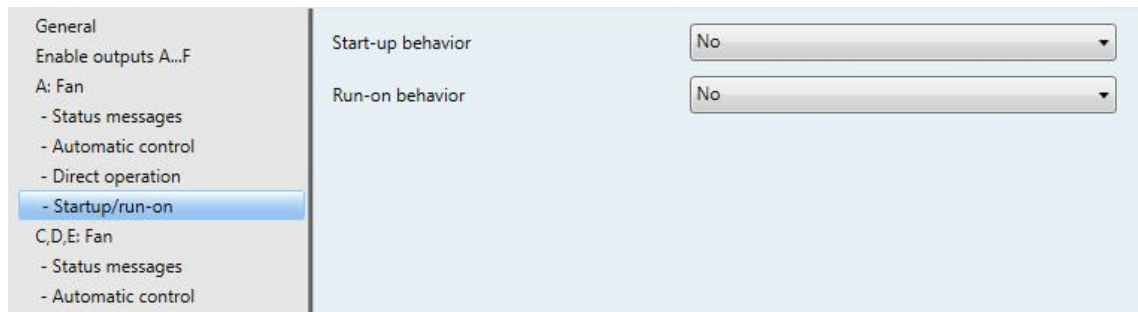

Start-up behavior

Options: No
Yes

This parameter enables the fan to start from the OFF state with a defined fan speed. This fan speed is immediately applied.

In order to guarantee that the fan motor starts safely, it can be useful to start it on a higher fan speed first so that the torque is higher during start-up.

Note

However, with a step switch, the previous fan speeds are switched on consecutively. With the changeover switch the fan speed is switched on right away.

The delay between the switchover of two fan speeds (contact change) is taken into account.

The dwell times in a fan speed, which are taken into account in automatic operation, are inactive and will only be taken into account after the start-up phase.

The start-up behavior is a technical characteristic of the fan. For this reason, this behavior has a higher priority than an active limitation or forced operation.

- Yes: The following parameters appear:

Switch on over fan speed

Options: 1/2/3

Here you set which speed the fan uses to start from the OFF state.

Minimum dwell period in switch on fan stage in s [1...65,535]

Options: 1...5...65,535

This parameter defines the minimum dwell time for one of the switch on speeds.

Example: Start-up behavior of a three-speed fan

The illustration shows the reaction in automatic operation with the option *Switch on over fan speed 3*, if the fan receives the telegram from the OFF state to set *Fan speed 1*.

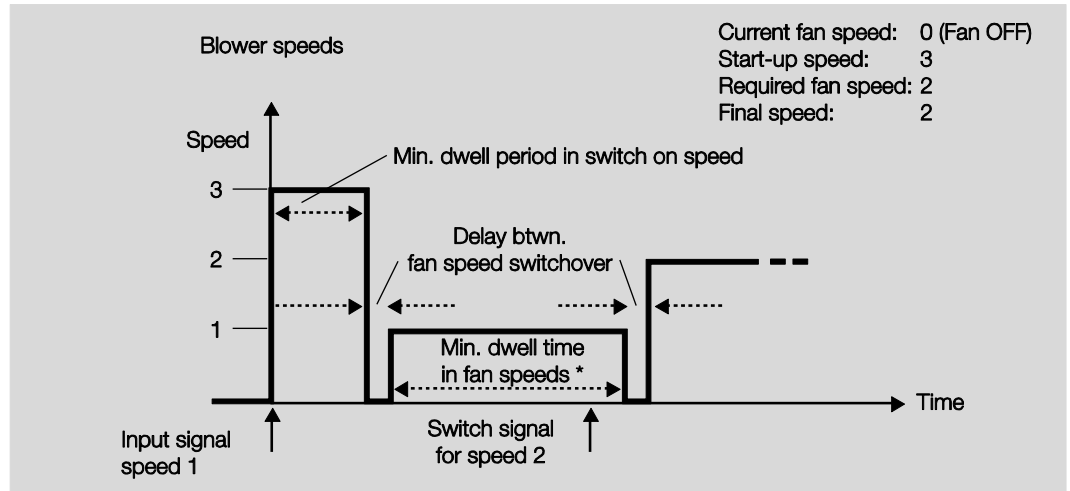

* The parameter *Minimum dwell period in fan speed in s [0...65,535]* in the parameter window *Automatic control* is only active and programmable if the *Enable automatic operation* parameter in the *Fan* parameter window is set to *Yes*.

Important

Forced operation remains valid and is taken into account.

The parameterized minimum fan speed dwell time for automatic control is ignored during manual operation.

The delay time with speed switchover remains active to protect the fan.

Run-on behavior

Options: No
Yes

This parameter activates a run-on for the fan. If the fan changes to a lower speed, it remains in the previous speed for as long as the parameterized run-on time and only then reduces the speed.

If the fan goes through several speed changes, run-on times are executed successively, adding on those times.

A run-on time of 0 seconds means that run-on is deactivated.

Run-on is executed regardless of where the speed change originates (automatic operation, direct operation, manual procedure, fan switch off).

- Yes: The following parameters appear:

Run-on stage 3 in s [0...65,535]

Options: 0...20...65,535

Run-on stage 2 in s [0...65,535]

Options: 0...20...65,535

Run-on stage 1 in s [0...65,535]

Options: 0...20...65,535

The parameterized run-on times can be switched on or off with the *Run-on* communication object.

3.2.2.2 Parameter window A: Fan (Two-level)

All settings for output A are made in this parameter window.

These explanations also apply to outputs C, D, E if the parameter *Outputs C, D, E* in [Parameter window Enable outputs A...F](#), p.20 is set to *Enable as fans*.

All settings for the *two-speed fan* are made in this parameter window.

General	Fan type	Multi-level
Enable outputs A...F	Limit fan speeds to 2	Yes
A: Fan	Fan operating mode (note technical data of fan!)	No
- Status messages	Delay between speed switchover in ms [50...5,000]	500
C,D,E: Fan	Fan speed on bus voltage failure	Unchanged
- Status messages	Fan speed on bus voltage recovery	Unchanged
- Automatic control	Enable communication object "Forced operation" 1 bit	No
	Enable automatic operation	No
	Enable direct operation	No
	Set startup/run-on	No

If you wish to use the device for controlling a two-speed fan, set the parameters as follows:

- In the *A: Fan* parameter window, select the *multi-level* option in the *Fan type* parameter.
- Select *Yes* in the *Limit fan speeds to 2* parameter.

Now a two-speed fan is controlled via fan speeds 1 and 2.

Fan speed 3 with all its parameters and options is now non-functional.

Note

Further parameters and their settings options are described in parameter window [Parameter window A: Fan \(Multi-level\)](#), p.21.

3.2.2.3 Parameter window - A: Fan (One-level)

All settings for output A are made in this parameter window.

These explanations also apply to outputs C, D, E if the parameter *Outputs C, D, E* in [Parameter window Enable outputs A...F](#), p.20 is set to *Enable as fans*.

All settings for the *single-speed fan* are made in this parameter window.

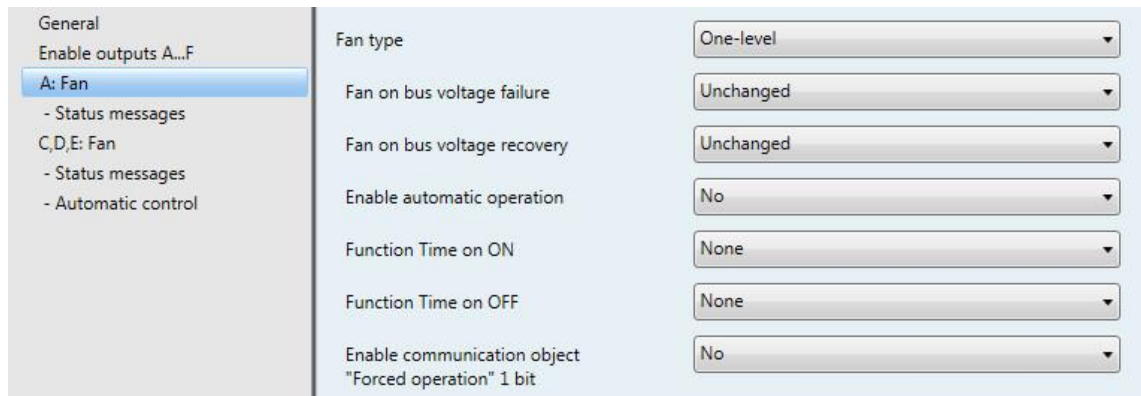

General	Fan type	One-level
Enable outputs A...F	Fan on bus voltage failure	Unchanged
A: Fan	Fan on bus voltage recovery	Unchanged
- Status messages	Enable automatic operation	No
C,D,E: Fan	Function Time on ON	None
- Status messages	Function Time on OFF	None
- Automatic control	Enable communication object "Forced operation" 1 bit	No

Fan type

Option: Multi-level
One-level

This parameter sets which type of fan is to be controlled.

To control a fan with up to three speeds select the *Multi-level* option.

To control a single-speed fan, select the *One-level* option.

Fan on bus voltage failure

Option: Unchanged
OFF
ON

The response of the fan on bus voltage failure is defined here.

- *Unchanged*: The fan speed remains the same.
- *OFF*: The fan is switched off.
- *ON*: The fan is switched on.

Fan on bus voltage recovery

Options: Unchanged
OFF
ON

The response of the fan on bus voltage recovery is defined here.

- *Unchanged*: The fan speed remains the same.
- *OFF*: The fan is switched off.
- *ON*: The fan is switched on.

Caution

The blower actuator is supplied ex-works with a default setting (factory default). This ensures that the fan setting is switched off when the bus voltage is applied to the relay for the first time, preventing any unintentional switch-on damage to the device during transport, e.g. due to vibration.

It is advisable to apply a bus voltage before connecting the fan in order to assign it a defined switch state. This eliminates the possibility of an incorrect contact setting destroying the fan.

Enable automatic operation

Options: No
Yes

- *Yes*: *Automatic operation* is enabled and Parameter window - *Automatic control* (One-level), p.49 appears.

Function Time on ON

Options: None
Switching delay
Minimum time

This defines the *Time* function on Fan ON.

- *None*: No *Time* function is executed.
- *Switching delay*: The fan is switched on after this delay.
- *Minimum time*: The fan remains ON for at least this time.

With the *Switching delay* option, the following parameters appear:

Time in s [1...65,535 x 0.1]

Options: 1...20...65,535

The fan is switched on after this delay.

With the *Minimum time* option, the following parameters appear:

Time in s [1...65,535]

Options: 1...20...65,535

The fan remains ON for at least this time.

Function Time on OFF

Options: None
Switching delay
Minimum time

This defines the *Time* function on Fan OFF.

- *None*: No *Time* function is executed.
- *Switching delay*: The fan is switched off after this delay.
- *Minimum time*: The fan remains OFF for at least this time.

With the *Switching delay* option, the following parameters appear:

Time in s [1...65,535 x 0.1]

Options: 1...20...65,535

The fan is switched off after this delay.

With the *Minimum time* option, the following parameters appear:

Time in s [1...65,535]

Options: 1...20...65,535

The fan remains OFF for at least this time.

Enable communication object "Forced operation" 1 bit

Options: No
Yes

- *Yes*: A 1 bit *Forced operation* communication object is enabled. The following parameters appear at the same time:

Forced operation on object value

Options: 1
0

- *1*: Forced operation is activated by a telegram with value 1.
- *0*: Forced operation is activated by a telegram with value 0.

Reaction on forced operation

Options: Unchanged
OFF
ON

This parameter defines how the fan should respond to a forced operation.

3.2.2.3.1 Parameter window - *Status messages* (One-level)

This is the parameter window where *status messages* are defined.

This parameter window is always visible for output A. For outputs C, D and E it is visible if the *Outputs C, D, E* parameter in [Parameter window Enable outputs A...F](#) on p.20 is set to *Enable as fans*.

The screenshot shows a software interface for configuring parameters. On the left is a tree view with the following items: 'General', 'Enable outputs A...F', 'A: Fan', '- Status messages' (highlighted), '- Automatic control', 'C,D,E: Fan', '- Status messages', and '- Automatic control'. The main area displays three rows of settings:

Enable communication object	Value
"Status Byte mode" 1 byte	No
"Status Fan On/Off" 1 bit	No
"Status Automatic" 1 bit	No

Enable communication object "Status Byte mode" 1 byte

Options: No
Yes

This status byte indicates the states Control value selection, Automatic, Forced operation and the four limitations via a 1 bit coding.

For further information see: [Fan status byte, forced/operation](#), p.98

- Yes: The communication object *Status Byte mode* is enabled and the following parameter appears:

Send object values

Options: No, update only
Only after changing
After request
After a change or request

- *No, update only*: The status is updated but not sent.
- *Only after changing*: The status is sent after a change.
- *After request*: The status is sent after a request.
- *After a change or request*: The status is sent after a change or a request.

Enable communication object "Status Fan On/Off" 1 bit

Options: No
 Yes

This parameter enables the communication object *Status Fan ON/OFF*.

Some fans initially need an ON telegram before they are set to a fan speed from the OFF state. This ON telegram has effect on a main switch which has to be switched on. This requirement can be implemented with any switch output controlled via the *Status Fan* communication object. The corresponding switch communication object of the switch actuator should be connected with the *Status Fan* communication object.

With the option *Yes*, the following parameters appear:

Send object value

Options: No, update only
 Only after changing
 After request
 After a change or request

- *No, update only*: The status is updated but not sent.
- *Only after changing*: The status is sent after a change.
- *After request*: The status is sent after a request.
- *After a change or request*: The status is sent after a change or a request.

The following parameter is only visible if the *Enable automatic operation* parameter in the *Fan* parameter window is set to *Yes*.

Enable communication object "Status Automatic" 1 bit

Options: No
 Yes

This parameter enables the communication object *Status Automatic*.

Telegram value 1 = automatic operation active
 0 = automatic operation inactive

- *Yes*: The following parameter appears:

Send object values

Options: No, update only
 Only after changing
 After request
 After a change or request

- *No, update only*: The status is updated but not sent.
- *Only after changing*: The status is sent after a change.
- *After request*: The status is sent after a request.
- *After a change or request*: The status is sent after a change or a request.

3.2.2.3.2 Parameter window - Automatic control (One-level)

This parameter window is visible if the *Enable automatic operation* parameter in [Parameter window - A: Fan \(One-level\)](#), p.44 is set to Yes.

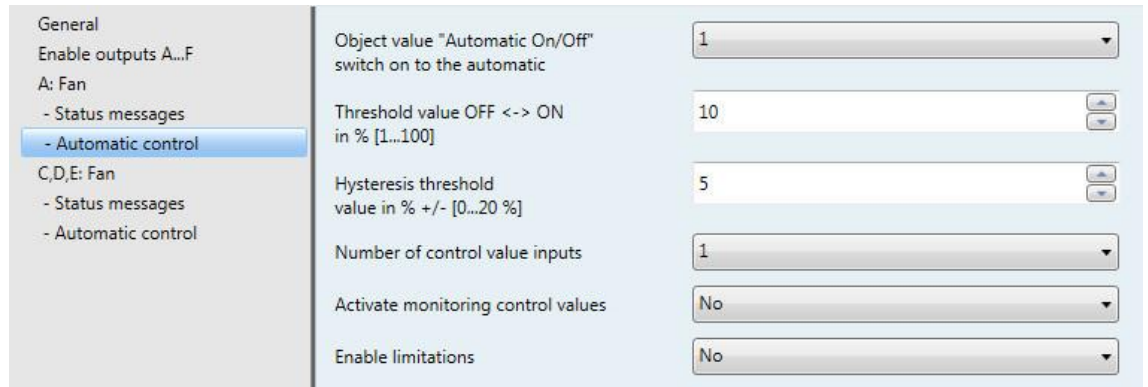

General	Object value "Automatic On/Off" switch on to the automatic	1
Enable outputs A...F	Threshold value OFF <-> ON in % [1...100]	10
A: Fan	Hysteresis threshold value in % +/- [0...20 %]	5
- Status messages	Number of control value inputs	1
- Automatic control	Activate monitoring control values	No
C,D,E: Fan	Enable limitations	No
- Status messages		
- Automatic control		

This is the parameter window where you define the threshold values for switchover of the fan speed. You can also enable limitations here.

Object value "Automatic On/Off" switch on to the automatic

Options: $\frac{1}{0}$

This parameter defines how the device should react to a telegram.

- 1: Automatic is activated by a telegram with value 1.
- 0: Automatic is activated by a telegram with value 0.

Threshold value OFF <-> ON in % [1...100]

Options: 1...10...100

This defines the threshold value at which switch on occurs. If the value in the control value communication object is greater than or equal to the parameterized threshold value, it is switched on. If the value is less, it is switched off.

Hysteresis threshold value in % +/- [0...20 %]

Options: 0...5...20

This sets a hysteresis at which switchover to the next fan speed occurs.

The setting 0 causes immediate switching without hysteresis.

The entered percentage value is directly added to or subtracted from the percentage value of *Threshold value speed x*. The result is a new upper or lower threshold value.

Switch threshold top (switch on) = threshold value + hysteresis

Switch threshold bottom (switch off) = threshold value - hysteresis

Example: Single-speed fan control with hysteresis

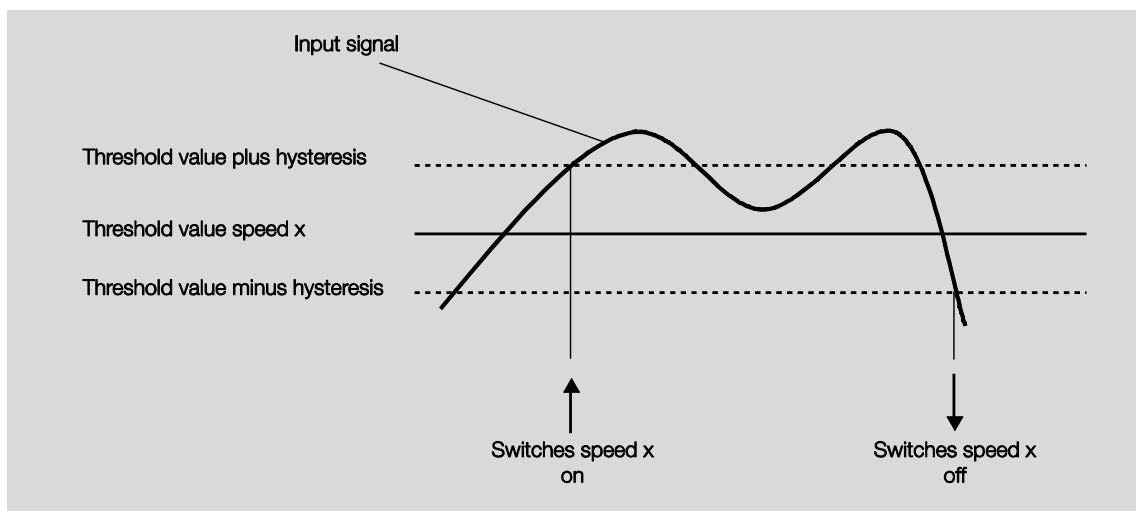

Using hysteresis avoids continual switching caused by fluctuating input signals around the threshold value.

Number of control value inputs

Options: $\frac{1}{2}$

This parameter defines the number of control value inputs (communication objects) for automatic operation.

- 1: There is only one *Control value* communication object.
- 2: There are two communication objects – *Control value A* and *Control value B* – and the following parameter appears:

select by...

Options: Largest value
Communication object "Control value A/B"

This parameter sets how the blower actuator selects which control value (A or B) to use.

- *Largest value*: The largest control value is always selected. If the values are equal (but not 0), the input that most recently received a value is selected.
- *Communication object "Control value A/B"*: The control value to use is selected via the communication object.

Activate monitoring control values

Options: No
Yes

This parameter sets the monitoring for the control value input(s), which detects any missing telegrams on the communication object(s).

- *No*: Control value monitoring is deactivated.
- *Yes*: Control value monitoring is activated.

With the option *Yes*, the following parameters appear:

Monitoring time in s [30...65,535]

Options: 0...120...65,535

This parameter sets the maximum time allowed between two telegrams. An error is reported if this time is exceeded.

Where there are two control value inputs, the following additional parameter appears:

Function of monitoring

Options: Monitoring current control values
 Monitoring active and inactive control values

This parameter determines the scope of monitoring.

- *Monitoring current control values*: Only the currently selected control value input is monitored for incoming telegram continuity. After a switchover (via *Communication object "Control value A/B"* or *Largest value*), monitoring restarts.
- *Monitoring active and inactive control values*: Both control value inputs are always monitored independently of each other. An error is reported if an object's time is exceeded.

Send object value "Fault control value"

Options: No, update only
 Only after changing
 After request
 After a change or request

- *No, update only*: The status is updated but not sent.
- *Only after changing*: The status is sent after a change.
- *After request*: The status is sent after a request.
- *After a change or request*: The status is sent after a change or a request.

Set control value during fault

Options: No
 Yes

This parameter sets the reaction in the event of an error.

- Yes: The following parameter appears:

Control value in % [0...100]

Options: 0...30...100

This parameter sets what percentage to use for the control value in the event of an error.

Enable limitations

Option: No
Yes

- Yes: Four communication objects, *Limitation x*, ($x = 1..4$), are enabled for limitation of the fan speed.

Speed ranges (limitations) are defined for the fan with the speed limitation function which may not be over/undershot.

Important

The parameterized start-up behavior which is a technical characteristic of the fan has a higher priority than a limitation, i.e. if a limitation is activated in fan speed 2 and start-up behavior is parameterized with fan speed 3, the following behavior will result: The fan is in the OFF state and receives a control signal for fan speed 1. First it goes to speed 3 (start-up speed), then 2, which is specified via the limitation. Due to the limitation, the actual required fan speed 1 will not be reached.

The sequence of the displayed parameters corresponds with their priorities, i.e. the parameter with the highest priority has limitation 1 followed by limitations 2, 3 and 4.

When you exit automatic mode, e.g. by a manual action, the limitations 1...4 remain.

The following points apply for limitations:

- The limitation need not necessarily apply to one fan speed only. It can also encompass another range of the fan speeds, i.e. only certain fan speeds can be set if the limitation is active. In this way, a limited control is also possible.
- The limitation is activated when a telegram with the value 1 is received on the limitation communication object, and is lifted when the same object receives a telegram with the value 0. A manual action ends automatic operation.
- If a limitation is activated, the device switches to the parameterized fan speed regardless of the control value. If another fan speed or a speed outside the "limitation range" is set when the limitation is activated, then the required speed or the limit speed of the range is set.
- After limitations are switched off, fan speed is recalculated and executed. This means that during limitation the actuator operates normally in the background, the outputs are not changed and implementation only occurs once limitation ends.

Each of the four limitations used to limit the fan speeds has the same parameters. They are prioritized according to the listed sequence. The highest priority is assigned to limitation 1 and the lowest to limitation 4.

Fan speed with limitation 1

Fan speed with limitation 3

Options: Inactive
 Unchanged
 OFF
 ON

This parameter sets the fan speed or speed range that applies under active limitation.

Fan speed with limitation 2

Fan speed with limitation 4

Options: Inactive
 Unchanged
 OFF
 ON

This parameter sets the fan speed or speed range that applies under active limitation.

3.2.2.4 Parameter window *B: Output*

Note
All of the following descriptions and operating options apply to both the FCL/S 1.6.1.1 1-fold Blower Actuator and the FCL/S 2.6.1.1 2-fold Blower Actuator.

All settings for output B are made in the *B: Output* parameter window.

These explanations also apply to outputs C, D, E if the parameter *Outputs C, D, E* in [Parameter window Enable outputs A...F](#), p.20 is set to *Enable as switch actuators*.

The explanations also apply for output F.

Outputs B...F must first be individually enabled in [Parameter window Enable outputs A...F](#), p.20.

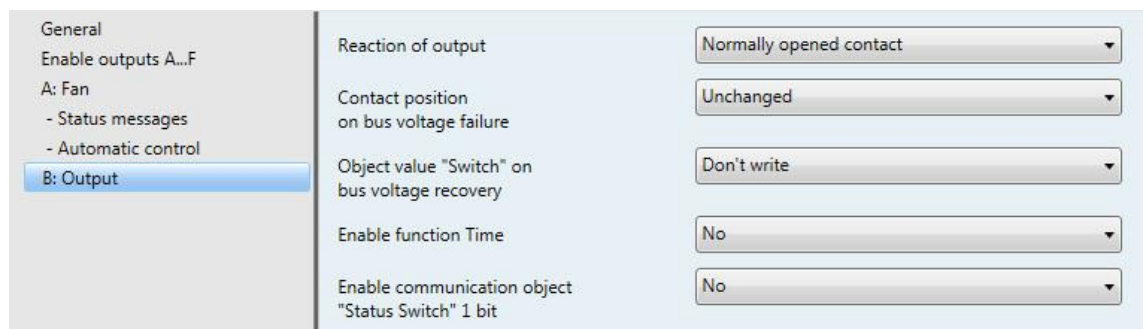

General	Reaction of output	Normally opened contact
Enable outputs A...F	Contact position on bus voltage failure	Unchanged
A: Fan	Object value "Switch" on bus voltage recovery	Don't write
- Status messages	Enable function Time	No
- Automatic control	Enable communication object "Status Switch" 1 bit	No
B: Output		

Reaction of output

Options: [Normally opened contact](#)
Normally closed contact

This parameter sets whether the output operates as a *normally closed contact* or *normally open contact*.

- *Normally opened contact*: An ON telegram (1) closes the contact, and an OFF telegram (0) opens the contact.
- *Normally closed contact*: An ON telegram (1) opens the contact, and an OFF telegram (0) closes the contact.

Contact position on bus voltage failure

Options: Normally closed
Normally Open
[Unchanged](#)

This parameter determines the response of the output on bus voltage failure.

- *Normally closed*: The output is OFF.
- *Normally open*: The output is ON.
- *Unchanged*: The output retains the last state before bus voltage failure.

Object value "Switch" on bus voltage recovery

Options: Don't write
 Write with "0"
 Write with "1"

This parameter determines the response of the communication object *Switch* after a bus voltage recovery. As standard the communication object *Switch* receives the value 0.

- *Don't write*: After bus voltage recovery, the value 0 is retained in the communication object *Switch*. The switch state is not re-determined.

Note

Before the very first download (device fresh from the factory), the value before bus voltage failure is undefined. For this reason, the communication object *Switch* is written with 0 and the contact is open.

- *Write with 0*: The communication object *Switch* is written with a 0 on bus voltage recovery. The contact position is redefined and set based on the set device parameterization.
- *Write with 1*: The communication object *Switch* is written with a 1 on bus voltage recovery. The contact position is redefined and set based on the set device parameterization.

Note

Take note of the reaction on bus voltage failure, recovery and download.

The device draws the energy for switching the contact from the bus. After bus voltage is applied, it takes about ten seconds before sufficient energy is available to switch all contacts simultaneously.

Depending on the transmission and switching delay on bus voltage recovery set in the *General* parameter window, the individual outputs will only assume the desired contact position after this time.

If a shorter time is set, the device will only switch the first contact when sufficient energy is stored in the device, in order to ensure that enough energy is available to immediately bring all outputs safely to the required position if there is another bus voltage failure.

Enable function Time

Options: No
 Yes

- *No*: The parameter window remains disabled and invisible.
- *Yes*: The *-Time* parameter window appears.

Enabling the *Time* function enables the *-Time* parameter window, where you can undertake further settings.

Note

For a more precise description of the function, see [Communication objects Output](#), p78, No.42.

Enable communication object "Status Switch" 1 bit

Options: No
 Yes

- Yes: The following parameters appear:

Send object value

Options: No, update only
 Only after changing
 After request
 After a change or request

- *No, update only*: The status is updated but not sent.
- *Only after changing*: The status is sent after a change.
- *After request*: The status is sent after a request.
- *After a change or request*: The status is sent after a change or a request.

Object value of contact position

Options: 1 = closed, 0 = open
 0 = closed, 1 = open

This parameter defines the communication object value of the switch status (*Status switch*).

- *1 = closed, 0 = open*: A closed contact is represented by communication object value 1 and an open contact by 0.
- *0 = closed, 1 = open*: A closed contact is represented by communication object value 0 and an open contact by 1.

Note
The contact position and thus the switch status can be the result of a series of priorities and links.

3.2.2.4.1 Parameter window B: Output - Time

All settings for the *Time: Staircase lighting* function are made in this parameter window.

This parameter window is visible if the *Enable function Time* parameter in [Parameter window B: Output](#), p. 55 is set to Yes.

The screenshot shows a software interface for configuring the 'Time: Staircase lighting' function. On the left, a sidebar lists navigation options: 'General', 'Enable outputs A...F', 'A: Fan', '- Status messages', '- Automatic control', 'B: Output', and '- Time' (which is selected). The main area is titled 'Function Time' and contains several settings:

- 'Staircase light' is set to 'Staircase light'.
- 'Extending staircase lighting by multiple operation ["pumping up"]' is set to 'Yes (retriggerable)'.
- 'Staircase lighting time in s [1...65,535]' is set to '30'.
- 'Staircase lighting can be switched' is set to 'ON with 1 and OFF with 0'.
- 'Restart of staircase time after end of permanent ON' is set to 'No'.
- 'Object value "Disable function Time" after a download' is set to '0 = enable function Time'.

Explanations of the Time functions and sequences can be found in [Planning and application](#), p.81. Please also refer to [Function diagram](#), p.89, from which the switching and timing priorities originate.

Function Time

Options: [Staircase light](#)

- *Staircase light*: The value that switches the staircase lighting on and off can be parameterized. The staircase lighting time starts when the function is switched on. It is switched off immediately after the staircase lighting time ends.

The following parameters appear when *Staircase light* is selected:

Extending staircase lighting by multiple operation ["pumping up"]

Options: no (not retriggerable)
 Yes (retriggerable)
 Up to max. 2 x staircase lighting time
 Up to max. 3 x staircase lighting time
 Up to max. 4 x staircase lighting time
 Up to max. 5 x staircase lighting time

If a further ON telegram is received during the staircase lighting time sequence, the remaining staircase lighting time can be extended. This is possible by repeated actuation of the push button ("pumping up") until the maximum parameterized number of retriggering operations is reached. The maximum time can be set to 1, 2, 3, 4 or 5 times the staircase lighting time.

Let's say the staircase lighting time has been extended by "pumping up" to the maximum time. If some of the time has already elapsed, the staircase lighting time can be re-extended to the maximum time by "pumping up" again. However, the parameterized maximum time may not be exceeded.

- *No (not retriggerable)*: The receipt of an ON telegram is ignored. The staircase lighting time continues unmodified to completion.
- *Yes (retriggerable)*: New ON telegrams reset the staircase lighting time and starts to count again. This process can be repeated as often as desired using this selection.
- *Up to max. 2/3/4/5 x staircase lighting time*: New ON telegrams extend the staircase lighting time by 2/3/4/5 times.

Staircase lighting time in s [1...65,535]

Options: 1...30...65,535

The staircase lighting time defines how long the contact is closed – provided that the contact is programmed as a n/o contact – and how long the light remains on after an ON telegram. The input is made in seconds.

Staircase lighting can be switched

Options: ON with 1 and OFF with 0
 ON with 1, no action with 0
 ON with 0 or 1, switch OFF not possible

This parameter defines the telegram value used for switching the staircase lighting on and off prematurely.

- *ON with 0 or 1, switch OFF not possible*: The function *Staircase lighting* is switched on independently of the value of the incoming telegram. Premature switch off is not possible.

Restart of staircase time after end of permanent ON

Options: No
 Yes

- *No*: The lighting switches off if *Permanent ON* is ended.
- *Yes*: The lighting remains on and the staircase lighting time restarts.

The function of Permanent ON is controlled via the *Permanent ON* communication object value. If the communication object receives a telegram with the value 1, the output is switched on regardless of the value of the communication object *Switch* and remains switched on until the communication object *Permanent ON* has the value 0.

Object value "Disable function Time" after a download

Options: Unchanged
 1 = disable function Time
 0 = enable function Time

- *Unchanged*: After a download, the communication object has the same value as before.
- *1 = disable function Time*: The *Time* function is disabled by a telegram with the value 1.
- *0 = disable function Time*: The *Time* function is disabled by a telegram with the value 0.

ABB i-bus[®] KNX Start-up

How does the staircase lighting react on bus voltage failure?

Reaction on bus voltage failure is determined by the parameter *Contact position on bus voltage failure* in [Parameter window B: Output](#), p.55.

How does the staircase lighting react on bus voltage recovery?

Reaction on bus voltage recovery is defined by the following conditions.

- By the parameterization of the communication object *Switch*. Whether the staircase lighting is switched on or off with bus voltage recovery depends on the programming of the communication object *Switch*.

If the staircase lighting time is interrupted by a bus voltage failure or by a download, it will continue afterwards.

After bus voltage failure this only applies if no other reaction has been parameterized.

3.2.3 Commissioning without bus voltage

How is the device switched on and put into operation?

The device can be made operational by applying an auxiliary voltage from the mobile power supply (NTI).

3.3 Communication objects

Note
As standard, the write flag (with the exception of 1 bit communication objects) is deleted with the communication object values. Thus the communication object value cannot be changed via the bus. If this function is required, the write flag must be set in ETS. The communication object value is overwritten with the parameterized value after bus voltage recovery.

3.3.1 Summary of communication objects

CO No.	Function	Name	Data Point Type (DPT)	Length	Flags				
					C	R	W	T	A
0	In Operation	System	1,002	1 bit	x			x	
1	Request status values	General	1,017	1 bit	x		x		
2...9	Not assigned								
10	Fan speed switch	Fan A	5,010	1 byte	x		x		
11	Switch speed 1	Fan A (Multi-level)	1,001	1 bit	x		x		
	Switch	Fan A (One-level)	1,001	1 bit	x		x		
12	Switch speed 2	Fan A (Multi-level)	1,001	1 bit	x		x		
13	Switch speed 3	Fan A (Multi-level)	1,001	1 bit	x		x		
14	Fan speed up/down	Fan A (Multi-level)	1,007	1 bit	x		x		
15	Status fan ON/OFF	Fan A	1,001	1 bit	x			x	
16	Status Fan speed	Fan A (Multi-level)	5,010	1 byte	x	x		x	
17	Status Fan speed 1	Fan A (Multi-level)	1,001	1 bit	x	x		x	
18	Status Fan speed 2	Fan A (Multi-level)	1,001	1 bit	x	x		x	
19	Status Fan speed 3	Fan A (Multi-level)	1,001	1 bit	x	x		x	
20	Run-on	Fan A (Multi-level)	1,003	1 bit	x		x		
21	Limitation 1	Fan A	1,003	1 bit	x		x		
22	Limitation 2	Fan A	1,003	1 bit	x		x		
23	Limitation 3	Fan A	1,003	1 bit	x		x		
24	Limitation 4	Fan A	1,003	1 bit	x		x		
25	Forced operation	Fan A	1,003	1 bit	x		x		
26	Automatic On/Off	Fan A	1,003	1 bit	x		x		
27	Status Automatic	Fan A	1,003	1 bit	x	x		x	
28	Status Byte mode	Fan A	non DPT	1 byte	x	x		x	
29	Control value A	Fan A (2 control values)	5,010	1 byte	x		x		
	Control value	Fan A (only 1 control value)	5,010	1 byte	x		x		
30	Control value B	Fan A (2 control values)	5,010	1 byte	x		x		
31	Toggle control value A/B	Fan A (2 control values)	1,001	1 bit	x		x		
32	Fault control value	Fan A	1,005	1 bit	x	x		x	
33...39	Not assigned								

ABB i-bus[®] KNX Start-up

CO No.	Function	Name	Data Point Type (DPT)	Length	Flags				
					C	R	W	T	A
40	Switch	Output B	1,001	1 bit	x		x		
41	Permanent ON	Output B	1,003	1 bit	x		x		
42	Disable function Time	Output B	1,003	1 bit	x		x		
43	Status Switch	Output B	1,001	1 bit	x	x		x	
44...49	Not assigned								
50	Fan speed switch	Fan CDE (Multi-level)	5,010	1 byte	x		x		
	Switch	Output C	1,001	1 bit	x		x		
51	Switch speed 1	Fan CDE (Multi-level)	1,001	1 bit	x		x		
	Switch	Fan CDE (One-level)	1,001	1 bit	x		x		
	Permanent ON	Output C	1,003	1 bit	x		x		
52	Switch speed 2	Fan CDE (Multi-level)	1,001	1 bit	x		x		
	Disable function Time	Output C	1,003	1 bit	x		x		
53	Switch speed 3	Fan CDE (Multi-level)	1,001	1 bit	x		x		
	Status Switch	Output C	1,001	1 bit	x	x		x	
54	Fan speed up/down	Fan CDE (Multi-level)	1,007	1 bit	x		x		
55	Status fan ON/OFF	Fan CDE	1,001	1 bit	x			x	
56	Status Fan speed	Fan CDE (Multi-level)	5,010	1 byte	x	x		x	
57	Status Fan speed 1	Fan CDE (Multi-level)	1,001	1 bit	x	x		x	
58	Status Fan speed 2	Fan CDE (Multi-level)	1,001	1 bit	x	x		x	
59	Status Fan speed 3	Fan CDE (Multi-level)	1,001	1 bit	x	x		x	
60	Switch	Output D	1,001	1 bit	x		x		
	Run-on	Fan CDE (Multi-level)	1,003	1 bit	x		x		
61	Limitation 1	Fan CDE	1,003	1 bit	x		x		
	Permanent ON	Output D	1,003	1 bit	x		x		
62	Limitation 2	Fan CDE	1,003	1 bit	x		x		
	Disable function Time	Output D	1,003	1 bit	x		x		
63	Limitation 3	Fan CDE	1,003	1 bit	x		x		
	Status Switch	Output D	1,001	1 bit	x	x		x	
64	Limitation 4	Fan CDE	1,003	1 bit	x		x		
65	Forced operation	Fan CDE	1,003	1 bit	x		x		
66	Automatic On/Off	Fan CDE	1,003	1 bit	x		x		
67	Status Automatic	Fan CDE	1,003	1 bit	x	x		x	
68	Status Byte mode	Fan CDE	non DPT	1 byte	x	x		x	
69	Control value A	Fan CDE (2 control values)	5,010	1 byte	x		x		
	Control value	Fan CDE (only 1 control value)	5,010	1 byte	x		x		
70	Control value B	Fan CDE (2 control values)	5,010	1 byte	x		x		
	Switch	Output E	1,001	1 bit	x		x		
71	Toggle control value A/B	Fan CDE (2 control values)	1,001	1 bit	x		x		
	Permanent ON	Output E	1,003	1 bit	x		x		
72	Fault control value	Fan CDE	1,005	1 bit	x	x		x	
	Disable function Time	Output E	1,003	1 bit	x		x		
73	Status Switch	Output E	1,001	1 bit	x	x		x	
74...79	Not assigned								

ABB i-bus[®] KNX Start-up

CO No.	Function	Name	Data Point Type (DPT)	Length	Flags				
					C	R	W	T	A
80	Switch	Output F	1,001	1 bit	x		x		
81	Permanent ON	Output F	1,003	1 bit	x		x		
82	Disable function Time	Output F	1,003	1 bit	x		x		
83	Status Switch	Output F	1,001	1 bit	x	x		x	

3.3.2 Communication objects *General*

No.	Function	Communication object name	Data type	Flags
0	In Operation	System	1 bit DPT 1.002	C, T
<p>The communication object is enabled if the parameter <i>Send communication object "In operation"</i> in the <i>General</i> parameter window is set to <i>Yes</i>.</p> <p>In order to regularly monitor the presence of the device on the KNX, an in operation monitoring telegram can be sent cyclically on the bus.</p> <p>As long as the communication object is activated, it sends a programmable in operation telegram.</p> <p>Telegram value 1 = system in operation with option <i>Send value 1 cyclically</i> 0 = system in operation with option <i>Send value 0 cyclically</i></p>				
1	Request status values	General	1 bit DPT 1.017	C, W
<p>The communication object is enabled if the parameter <i>Enable communication object "Request status values" 1 bit</i> in the <i>General</i> parameter window is set to <i>Yes</i>.</p> <p>If the communication object receives a telegram with the value x (x = 0; 1; 0 or 1), all status objects are sent on the bus, as long as these have not been programmed with the option <i>Only after changing or After request or After a change or request</i>.</p> <p>Option x = 1 produces the following function:</p> <p>Telegram value: 1 = all status messages are sent. 0 = nothing happens.</p>				

ABB i-bus[®] KNX Start-up

3.3.3

Communication objects *Fan A* and *Fan CDE*

Note
<p>Only the FCL/S 2.6.1.1 2-fold actuator can control the second Fan CDE.</p> <p>All three fan speeds can also be individually parameterized as outputs C, D and E. See Communication objects Output, p.78 for descriptions of the communication objects.</p> <p>The settings options are described in Parameter window Enable outputs A...F, p.20.</p>

3.3.3.1

Communication objects *Fan Multi-level*

No.	Function	Communication object name	Data type	Flags																								
10 50	Fan speed switch	Fan A Fan CDE	1 byte DPT 5.010	C, W																								
<p>The communication object is enabled if the parameters <i>Enable direct operation</i> and <i>Enable communication object "Switch speed" 1 byte</i> in the <i>A: Fan</i> or <i>CDE: Fan</i> parameter window are set to <i>Yes</i>.</p> <p>With this communication object, the fan can be switched on via a 1 byte communication object of a fan speed. If another fan speed is switched on, at this point it will be switched off. The new fan speed is switched on taking the start-up phase into account.</p> <p>Limitations through forced operation or one of the four limitations 1...4 are retained. Automatic operation is disabled. Communication object <i>Automatic ON/OFF</i> reactivates automatic operation.</p> <p>The following telegram values result:</p> <table border="1" style="margin-left: 40px;"> <thead> <tr> <th>1 byte value</th> <th>Hexadecimal</th> <th>Binary value bit 76543210</th> <th>Fan speed</th> </tr> </thead> <tbody> <tr> <td>0</td> <td>00</td> <td>00000000</td> <td>0 (OFF)</td> </tr> <tr> <td>1</td> <td>01</td> <td>00000001</td> <td>Fan speed 1</td> </tr> <tr> <td>2</td> <td>02</td> <td>00000010</td> <td>Fan speed 2</td> </tr> <tr> <td>3</td> <td>03</td> <td>00000011</td> <td>Fan speed 3</td> </tr> <tr> <td>>3</td> <td>>03</td> <td>>00000011</td> <td>Values greater than 3 are ignored</td> </tr> </tbody> </table>					1 byte value	Hexadecimal	Binary value bit 76543210	Fan speed	0	00	00000000	0 (OFF)	1	01	00000001	Fan speed 1	2	02	00000010	Fan speed 2	3	03	00000011	Fan speed 3	>3	>03	>00000011	Values greater than 3 are ignored
1 byte value	Hexadecimal	Binary value bit 76543210	Fan speed																									
0	00	00000000	0 (OFF)																									
1	01	00000001	Fan speed 1																									
2	02	00000010	Fan speed 2																									
3	03	00000011	Fan speed 3																									
>3	>03	>00000011	Values greater than 3 are ignored																									
11 51	Switch speed 1	Fan A Fan CDE	1 bit DPT 1.001	C, W																								
<p>The communication object is enabled if the parameters <i>Enable direct operation</i> and <i>Enable communication object "Switch speed x" 1 bit</i> in the <i>Fan: A</i> or <i>Fan: CDE</i> parameter window are set to <i>Yes</i>.</p> <p>Via the 1 bit communication object the device can receive a control value for fan speed 1.</p> <p>Limitations through forced operation or one of the four limitations 1...4 are retained. Automatic operation is disabled. Communication object <i>Automatic ON/OFF</i> reactivates automatic operation.</p> <p>If several ON telegrams are received consecutively in a short period of time at various <i>Switch speed x</i> ($x = 1...3$) communication objects, the value last received is the one that will control the fan. An OFF telegram to one of the three communication objects <i>Switch speed x</i> ($x = 1...3$) switches the fan off.</p> <p>Telegram value: 0 = fan OFF 1 = fan ON in speed 1</p>																												
12 52	Switch speed 2																											
See communication object 11																												
13 53	Switch speed 3																											
See communication object 11																												

No.	Function	Communication object name	Data type	Flags																				
14 54	Fan speed up/down	Fan A Fan CDE	1 bit DPT 1.007	C, W																				
<p>The communication object is enabled if the parameters <i>Enable direct operation</i> and <i>Enable communication object "Fan speed up/down" 1 bit</i> in the <i>A: Fan</i> or <i>CDE: Fan</i> parameter window are set to <i>Yes</i>.</p> <p>With this communication object, the fan can be switched one fan speed further up or down via a 1 bit telegram. Switching (up/down) is determined by the telegram value.</p> <p>With multiple manual up or down switching, the required speed will be increased or reduced by a speed step. This is feasible until the maximum or minimum possible speed is reached. The parameterized limitations are taken into account here. Further up or down telegrams are ignored and not executed. Each new switching telegram initiates a recalculation of the required speed.</p> <p>Telegram value: 0 = switch fan speed down 1 = switch fan speed up</p>																								
15 55	Status fan ON/OFF	Fan A Fan CDE	1 bit DPT 1.001	C, T																				
<p>The communication object is enabled if the parameter <i>Enable communication object "Status fan On/Off" 1 bit</i> in the – <i>Status messages</i> parameter window is set to <i>Yes</i>.</p> <p>The communication object receives the communication object value 1 (ON), if at least one fan speed is not equal to zero (OFF). The value of the communication object is sent if not equal to zero. This communication object thus indicates the status of the fan, whether it is switched on or off.</p> <p>Telegram value: 0 = OFF 1 = ON</p> <div style="border: 1px solid black; padding: 5px; margin-top: 10px;"> <p>Note</p> <p>Some fans require an ON telegram before you set a fan speed. Using the communication object <i>Status fan ON/OFF</i>, the fan can, for example, be switched on centrally with a switch actuator via the main switch.</p> </div>																								
16 56	Status Fan speed	Fan A Fan CDE	1 byte DPT 5.010	C, R, T																				
<p>The communication object is enabled if the parameter <i>Enable communication object "Status fan speed" 1 byte</i> in parameter window <i>Status messages</i> is set to <i>Yes</i>.</p> <p>You can parameterize whether the communication object value is updated only, or sent on the bus, After a change or request. It is possible to parameterize whether the actual or required speed is displayed with the status communication object. This communication object allows you, for example, to display the fan speed as a figure value.</p> <p>The following telegram values apply for the 1 byte communication object:</p> <table border="1" style="margin-left: auto; margin-right: auto;"> <thead> <tr> <th>Figure value</th> <th>Hexadecimal</th> <th>Binary value bit 76543210</th> <th>Fan speed</th> </tr> </thead> <tbody> <tr> <td>0</td> <td>00</td> <td>00000000</td> <td>0 (OFF)</td> </tr> <tr> <td>1</td> <td>01</td> <td>00000001</td> <td>Fan speed 1</td> </tr> <tr> <td>2</td> <td>02</td> <td>00000010</td> <td>Fan speed 2</td> </tr> <tr> <td>3</td> <td>03</td> <td>00000011</td> <td>Fan speed 3</td> </tr> </tbody> </table>					Figure value	Hexadecimal	Binary value bit 76543210	Fan speed	0	00	00000000	0 (OFF)	1	01	00000001	Fan speed 1	2	02	00000010	Fan speed 2	3	03	00000011	Fan speed 3
Figure value	Hexadecimal	Binary value bit 76543210	Fan speed																					
0	00	00000000	0 (OFF)																					
1	01	00000001	Fan speed 1																					
2	02	00000010	Fan speed 2																					
3	03	00000011	Fan speed 3																					

ABB i-bus[®] KNX Start-up

No.	Function	Communication object name	Data type	Flags
17 57	Status Fan speed 1	Fan A Fan CDE	1 bit DPT 1.001	C, R, T
<p>The communication object is enabled if the parameter <i>Enable communication object "Status fan speed x" 1 bit</i> in the <i>Status messages</i> parameter window is set to Yes.</p> <p>You can parameterize whether the communication object value is updated but not sent, sent on request, or only sent when changed.</p> <p>You can also parameterize whether the status should indicate a current fan speed or a required fan speed. This communication object allows you to display the fan speed in a visualization or to indicate it on a display.</p> <p>Telegram value: 0 = fan speed OFF 1 = fan speed ON</p>				
18 58	Status Fan speed 2			
See communication object 17				
19 59	Status Fan speed 3			
See communication object 17				
20 60	Run-on	Fan A Fan CDE	1 bit DPT 1.003	C, W
<p>The communication object is enabled if run-on behavior has been enabled in parameter window A: <i>Fan - Startup/Run-on or CDE: Fan - Startup/Run-on</i>.</p> <p>If run-on behavior is enabled, it will be activated after an ETS reset or by an ON telegram on this communication object.</p> <p>Telegram value: 0 = run-on disabled 1 = run-on enabled</p>				
21 61	Limitation 1	Fan A Fan CDE	1 bit DPT 1.003	C, W
<p>The communication object is enabled if the parameter <i>Enable limitations</i> in parameter window <i>Automatic control</i> is set to Yes.</p> <div style="border: 1px solid black; padding: 5px; margin: 10px 0;"> <p>Note</p> <p>Limitation 1 is only active in automatic operation.</p> </div> <p>Limitation 1 is active when communication object <i>Limitation 1</i> receives a telegram with the value 1, and is lifted when the same communication object receives a telegram with the value 0.</p> <p>When Limitation 1 is activated, the fan can only assume the fan speed or speed range as set in the parameter <i>Speed with limitation 1</i>.</p> <p>Telegram value: 0 = limitation x inactive 1 = limitation x active</p>				
22 62	Limitation 2			
See communication object 21				
23 63	Limitation 3			
See communication object 21				
24 64	Limitation 4			
See communication object 21				

No.	Function	Communication object name	Data type	Flags
25 65	Forced operation	Fan A Fan CDE	1 bit DPT 1.003	C, W
<p>The communication object is enabled if the parameter <i>Enable communication object "Forced operation" 1 bit</i> in the <i>A: Fan or CDE: Fan</i> parameter window is set to Yes.</p> <p>If a forced operation is activated, the device switches to forced operation regardless of the control value and its parameterized Limitation 1-4.</p> <p>Telegram value: 0 = no forced operation 1 = forced operation</p>				
26 66	Automatic ON/OFF	Fan A Fan CDE	1 bit DPT 1.003	C, W
<p>The communication object is enabled if <i>Automatic operation</i> has been enabled in the <i>A: Fan or CDE: Fan</i> parameter window. If automatic operation is enabled, it will be activated after a download, an ETS reset or by an ON telegram on this communication object.</p> <p>Automatic mode is switched off if a telegram is received on a "manual communication object".</p> <p>Manual communication objects are:</p> <ul style="list-style-type: none"> • Fan: Fan speed switch • Fan: Switch speed x (x = 1, 2 or 3) • Fan: Fan speed up/down • Fan: Limitation x (x = 1, 2, 3 or 4) <p>During forced operation, automatic mode remains active but operates only within the allowed limits.</p> <p>If the value 1 is set in the parameter:</p> <p>Telegram value 0 = automatic operation OFF 1 = automatic operation ON</p> <p>If the value 0 is set in the parameter:</p> <p>Telegram value 0 = automatic operation ON 1 = automatic operation OFF</p>				
27 67	Status Automatic	Fan A Fan CDE	1 bit DPT 1.003	C, R, T
<p>The communication object is enabled if the parameter <i>Enable communication object "Status Automatic" 1 bit</i> in parameter window - <i>Status messages</i> is set to Yes.</p> <p>You can parameterize whether the communication object value is updated but not sent, sent on request, or only sent when changed.</p> <p>The communication object indicates the status of automatic operation.</p> <p>Telegram value: 0 = inactive 1 = activated</p>				

ABB i-bus[®] KNX Start-up

No.	Function	Communication object name	Data type	Flags
28	Status Byte mode	Fan A Fan CDE	1 byte non DPT	C, R, T
<p>The communication object is enabled if the parameter <i>Enable communication object "Status byte mode" 1 byte</i> in parameter window - <i>Status messages</i> is set to <i>Yes</i>.</p> <p>The operating state of the fan can be displayed or sent on the bus via this communication object. You can parameterize whether the communication object value is updated but not sent, sent on request, or only sent when changed.</p> <p>Bit sequence: 76543210</p> <p>Bit 7: Forced operation Telegram value: 0: inactive 1: active</p> <p>Bit 6: Limitation 1 Telegram value: 0: inactive 1: active</p> <p>Bit 5: Limitation 2 Telegram value: 0: inactive 1: active</p> <p>Bit 4: Limitation 3 Telegram value: 0: inactive 1: active</p> <p>Bit 3: Limitation 4 Telegram value: 0: inactive 1: active</p> <p>Bit 2: Thermostat fault Telegram value: 0: inactive 1: active</p> <p>Bit 1: Automatic Telegram value: 0: inactive 1: active</p> <p>Bit 0: Control value Telegram value: 0: control value A 1: Control value B</p> <p>For further information see: Fan status byte, forced/operation, p.98</p>				

No.	Function	Communication object name	Data type	Flags		
29 69	Control value A (if 2 control values) or Control value (if only 1 control value)	Fan A Fan CDE	1 byte DPT 5.010	C, W		
<p>The communication object is enabled if the parameter <i>Enable automatic operation</i> has been enabled in the <i>Fan</i> parameter window.</p> <p>Using this communication object the control value for automatic operation is predefined as a 1 byte value [0...255].</p>						
30 70	Control value B (if 2 control values)	Fan A Fan CDE	1 byte DPT 5.010	C, W		
<p>The communication object is enabled if the parameter <i>Enable automatic operation</i> has been enabled in the <i>Fan</i> parameter window and two outputs have been activated via the <i>Number of control value inputs</i> parameter in the <i>Automatic control</i> parameter window.</p> <p>Using this communication object the second control value for automatic operation is predefined as a 1 byte value [0...255].</p>						
31 71	Toggle control value A/B (if 2 control values)	Fan A Fan CDE	1 bit DPT 1.001	C, W		
<p>The communication object is enabled if two control value (A and B) communication objects have been activated in the <i>Automatic control</i> parameter window and they are to be selected via a communication object.</p> <p>Telegram value: 0 = Control value A 1 = Control value B</p>						
32 72	Fault control value	Fan A Fan CDE	1 bit DPT 1.005	C, R, T		
<p>The communication object is enabled if the parameter <i>Activate monitoring control values</i> in parameter window <i>Automatic control</i> is set to <i>Yes</i>.</p> <p>This communication object displays control value faults</p> <p>The blower actuator uses the <i>Fault control value</i> communication object to report a fault and then responds according to the parameterization for faults.</p> <p>Telegram value: 0 = no fault 1 = fault</p>						
<table border="1" style="width: 100%;"> <thead> <tr> <th style="background-color: #e0e0e0;">Note</th> </tr> </thead> <tbody> <tr> <td>If no value is sent to the communication object <i>Control value A</i>, <i>Control value B</i> or <i>Control Value</i> for a set time, a sender fault is assumed. If communication object 31, <i>Toggle control value A/B</i>, receives a value, the monitoring time is started.</td> </tr> </tbody> </table>					Note	If no value is sent to the communication object <i>Control value A</i> , <i>Control value B</i> or <i>Control Value</i> for a set time, a sender fault is assumed. If communication object 31, <i>Toggle control value A/B</i> , receives a value, the monitoring time is started.
Note						
If no value is sent to the communication object <i>Control value A</i> , <i>Control value B</i> or <i>Control Value</i> for a set time, a sender fault is assumed. If communication object 31, <i>Toggle control value A/B</i> , receives a value, the monitoring time is started.						

3.3.3.2 Communication objects *Fan One-level*

No.	Function	Object name	Data type	Flags
10 50				
Not assigned				
11 51	Switch	Fan A Fan CDE	1 bit DPT 1.001	C, W
<p>The communication object is enabled if the parameter <i>Fan type</i> in the <i>A: Fan</i> or <i>CDE: Fan</i> parameter window is set to <i>One-level</i>.</p> <p>The fan can be switched on or off with this 1 bit communication object.</p> <p>Limitations through forced operation or one of the four limitations 1...4 are retained. Automatic operation is disabled. Communication object <i>Automatic ON/OFF</i> reactivates automatic operation.</p> <p>If several ON telegrams with the value 1 are received, the last value received will be the one used to control the fan. An OFF command switches the fan off.</p> <p>Telegram value: 0 = fan OFF 1 = fan ON</p>				
12...14 52...54				
Not assigned				
15 55	Status fan ON/OFF	Fan A Fan CDE	1 bit DPT 1.001	C, T
<p>The communication object is enabled if the parameter <i>Enable communication object "Status fan On/Off" 1 bit</i> in the <i>Status messages</i> parameter window is set to <i>Yes</i>.</p> <p>The communication object receives the communication object value 1 (ON), if the fan speed is not equal to zero (OFF). The value of the communication object is updated and sent when the fan speed is changed.</p> <p>This communication object thus defines the status of the fan, whether it is switched on or off. It can also be used for control of a main switch for the fan.</p> <p>Telegram value: 0 = OFF 1 = ON</p> <div style="border: 1px solid black; padding: 5px; margin-top: 10px;"> <p>Note</p> <p>Some fans require an ON telegram before you set a fan speed. Using the communication object <i>Status fan ON/OFF</i>, the fan can, for example, be switched on centrally with a switch actuator via the main switch.</p> </div>				
16...20 56...60				
Not assigned				

No.	Function	Object name	Data type	Flags
21 61	Limitation 1	Fan A Fan CDE	1 bit DPT 1.003	C, W
<p>The communication object is enabled if the parameter <i>Enable limitations</i> in parameter window <i>Automatic control</i> is set to <i>Yes</i>.</p> <div style="border: 1px solid black; padding: 5px; margin: 10px 0;"> <p>Note</p> <p>Limitation 1 is only active in automatic operation.</p> </div> <p>Limitation 1 is active if the communication object <i>Limitation 1</i> receives a telegram with the value 1 and deactivated if the same communication object receives a telegram with the value 0. When Limitation 1 is activated, the fan can only assume the fan speed or speed range which has been set in the parameter window <i>Fan limitation</i>. Telegram value: 0 = limitation x inactive 1 = limitation x active</p>				
22 62	Limitation 2			
See communication object 21				
23 63	Limitation 3			
See communication object 21				
24 64	Limitation 4			
See communication object 21				
25 65	Forced operation	Fan A Fan CDE	1 bit DPT 1.003	C, W
<p>The communication object is enabled if the parameter <i>Enable communication object "Forced operation" 1 bit</i> in the <i>A: Fan or CDE: Fan</i> parameter window is set to <i>Yes</i>. If a forced operation is activated, the device switches to forced operation regardless of the control value and its parameterized Limitation 1..4. Telegram value: 0 = no forced operation 1 = forced operation</p>				

ABB i-bus[®] KNX Start-up

No.	Function	Object name	Data type	Flags
26 66	Automatic ON/OFF	Fan A Fan CDE	1 bit DPT 1.003	C, W
<p>The communication object is enabled if the parameter <i>Enable automatic operation</i> in the <i>A: Fan</i> or <i>CDE: Fan</i> parameter window is set to <i>Yes</i>.</p> <p>If automatic operation is enabled, it will be activated on this communication object after a download, an ETS reset or receiving a telegram with the value 1. Automatic operation is switched off if a signal is received on a "manual communication object".</p> <p>Manual communication objects are:</p> <ul style="list-style-type: none"> • <i>Fan: Fan speed switch</i> • <i>Fan: Switch speed x (x = 1, 2 or 3)</i> • <i>Fan: Fan speed up/down</i> • <i>Fan: Limitation x (x = 1, 2, 3 or 4)</i> <p>During one of the four limitations or forced operation, automatic mode remains active but operates only within the allowed limits.</p> <p>If the value 1 is set in the parameter: Telegram value 0 = automatic operation OFF 1 = automatic operation ON</p> <p>If the value 0 is set in the parameter: Telegram value 0 = automatic operation ON 1 = automatic operation OFF</p>				
27 67	Status Automatic	Fan A Fan CDE	1 bit DPT 1.003	C, R, W
<p>The communication object is enabled if the parameter <i>Enable communication object "Status Automatic"</i> 1 bit in parameter window - <i>Status messages</i> is set to <i>Yes</i>.</p> <p>You can parameterize whether the communication object value is updated but not sent, sent on request, or only sent when changed.</p> <p>The communication object indicates the status of automatic operation.</p> <p>Telegram value: 0 = inactive 1 = activated</p>				

ABB i-bus[®] KNX Start-up

No.	Function	Object name	Data type	Flags
28 68	Status Byte mode	Fan A Fan CDE	1 byte non DPT	C, R, T
<p>The communication object is enabled if the parameter <i>Enable communication object "Status byte mode" 1 byte</i> in parameter window - <i>Status messages</i> is set to <i>Yes</i>.</p> <p>The operating state of the fan can be displayed or sent on the bus via this communication object. You can parameterize whether the communication object value is updated but not sent, sent on request, or only sent when changed.</p> <p>Bit sequence: 76543210</p> <p>Bit 7: Forced operation Telegram value: 0: inactive 1: active</p> <p>Bit 6: Limitation 1 Telegram value: 0: inactive 1: active</p> <p>Bit 5: Limitation 2 Telegram value: 0: inactive 1: active</p> <p>Bit 4: Limitation 3 Telegram value: 0: inactive 1: active</p> <p>Bit 3: Limitation 4 Telegram value: 0: inactive 1: active</p> <p>Bit 2: Thermostat fault Telegram value: 0: inactive 1: active</p> <p>Bit 1: Automatic Telegram value: 0: inactive 1: active</p> <p>Bit 0: Control value Telegram value: 0: control value A 1: Control value B</p> <p>For further information see: Fan status byte, forced/operation, p.98</p>				

ABB i-bus[®] KNX Start-up

No.	Function	Object name	Data type	Flags		
29 69	Control value A (if 2 control values) or Control value (if only 1 control value)	Fan A Fan CDE	1 byte DPT 5.010	C, W		
<p>The communication object is enabled if the parameter <i>Enable automatic operation</i> has been enabled in the <i>Fan</i> parameter window.</p> <p>Using this communication object the control value for automatic operation is predefined as a 1 byte value [0...255].</p>						
30 70	Control value B (if 2 control values)	Fan A Fan CDE	1 byte DPT 5.010	C, W		
<p>The communication object is enabled if the parameter <i>Enable automatic operation</i> has been enabled in the <i>Fan</i> parameter window and two outputs have been activated via the <i>Number of control value inputs</i> parameter in the <i>Automatic control</i> parameter window.</p> <p>Using this communication object the second control value for automatic operation is predefined as a 1 byte value [0...255].</p>						
31 71	Toggle control value A/B (if 2 control values)	Fan A Fan CDE	1 bit DPT 1.001	C, W		
<p>The communication object is enabled if two control value (A and B) communication objects have been activated in the <i>Automatic control</i> parameter window, and they are to be selected by a communication object.</p> <p>Telegram value: 0 = Control value A 1 = Control value B</p>						
32 72	Fault control value	Fan A Fan CDE	1 bit DPT 1.005	C, R, T		
<p>The communication object is enabled if the parameter <i>Activate monitoring control values</i> in parameter window <i>Automatic control</i> is set to <i>Yes</i>.</p> <p>This communication object displays control value faults</p> <p>The blower actuator uses the <i>Fault control value</i> communication object to report a fault and then responds according to the parameterization for faults.</p> <p>Telegram value: 0 = no fault 1 = fault</p>						
<table border="1" style="width: 100%;"> <thead> <tr> <th style="text-align: left;">Note</th> </tr> </thead> <tbody> <tr> <td>If no value is sent to the communication object <i>Control value A</i>, <i>Control value B</i> or <i>Control Value</i> for a set time, a sender fault is assumed. If communication object 31, <i>Toggle control value A/B</i>, receives a value, the monitoring time is started.</td> </tr> </tbody> </table>					Note	If no value is sent to the communication object <i>Control value A</i> , <i>Control value B</i> or <i>Control Value</i> for a set time, a sender fault is assumed. If communication object 31, <i>Toggle control value A/B</i> , receives a value, the monitoring time is started.
Note						
If no value is sent to the communication object <i>Control value A</i> , <i>Control value B</i> or <i>Control Value</i> for a set time, a sender fault is assumed. If communication object 31, <i>Toggle control value A/B</i> , receives a value, the monitoring time is started.						

3.3.4 Communication objects *Output*

Note

The FCL/S 1.6.1.1 outputs are:

- A: Fan output
- B: Switch actuator output

The FCL/S 2.6.1.1 outputs are:

- A: Fan output
- B: Switch actuator output
- C, D, E: One fan output or parameterizable as switch actuators
- F: Switch actuator output

The parameter settings options for *Outputs B, C...E* and *F* are described in [Parameter window B: Output](#), p.55.

FCL/S 1.6.1.1:

The *Output B* communication objects are numbers 40...43.

FCL/S 2.6.1.1:

The *Output B* communication objects are numbers 40...43.

The *Output C* communication objects are numbers 50...53.

The *Output D* communication objects are numbers 60...63.

The *Output E* communication objects are numbers 70...73.

The *Output F* communication objects are numbers 80...83.

The communication objects are the same for all outputs. They are therefore explained here using *Output B*.

ABB i-bus[®] KNX Start-up

No.	Function	Object name	Data type	Flags
40	Switch	Output B	1 bit DPT 1.001	C, W
<p>The communication object is enabled if the parameter <i>Output B</i> has been enabled in the parameter window <i>Enable Outputs A...F</i>.</p> <p>This communication object is used for switching the output ON/OFF. The device receives a switch telegram via a switch communication object.</p> <p>N/O: Telegram value 1 = switch ON 0 = switch OFF</p> <p>N/C: Telegram value 1 = switch OFF 0 = switch ON</p> <div style="border: 1px solid black; padding: 5px; margin-top: 10px;"> <p>Note</p> <p>With logical connections or forced operations, modifying communication object <i>Switch</i> does not necessarily result in a changed contact position.</p> <p>For further information see: Function diagram, p.89</p> </div>				
41	Permanent ON	Output B	1 bit DPT 1.003	C, W
<p>The communication object is enabled if the parameter <i>Enable function Time</i> in the <i>B: Output</i> parameter window is set to <i>Yes</i>. The output can be forcibly switched on with this communication object.</p> <p>If the communication object is assigned with the value 1, the output is switched on irrespective of the value of the communication object <i>Switch</i> and remains switched on until the communication object <i>Permanent ON</i> has the value 0. When the Permanent ON state ends, the state of the communication object <i>Switch</i> is used.</p> <p><i>Permanent ON</i> only switches ON and "masks" the other functions. This means that the other functions, e.g. Staircase lighting, continue to run in the background but do not initiate a switching action. When Permanent ON ends, the contact position which would result without the Permanent ON function becomes active. For the <i>Staircase lighting</i> function, the response after Permanent ON can be parameterized in Parameter window B: Output - Time, p.58.</p> <p>This communication object can be used, for example, to allow service or maintenance and cleaning personnel to initiate a permanent ON. The device receives a switch telegram via the Switch object.</p> <p>Permanent ON becomes inactive after a download or bus voltage recovery.</p> <p>Telegram value 1 = activates permanent ON mode 0 = deactivates permanent ON mode</p>				

ABB i-bus[®] KNX Start-up

No.	Function	Object name	Data type	Flags
42	Disable function Time	Output B	1 bit DPT 1.003	C, W
<p>The communication object is enabled if the parameter <i>Enable function Time</i> in the <i>B: Output</i> parameter window is set to <i>Yes</i>. The communication object value after a download can be determined in parameter window - <i>Time</i>, using the parameter <i>Object value "Disable function Time" after a download</i>. With the <i>Time</i> function disabled, the output can only be switched on or off; the <i>Staircase lighting</i> function is not triggered. Telegram value 1 = staircase lighting disabled 0 = staircase lighting enabled</p> <p>The contact position at the time of disabling and enabling is retained and will only be changed with the next switch telegram to communication object <i>Switch</i>.</p>				
43	Status Switch	Output B	1 bit DPT 1.001	C, R, T
<p>The communication object is enabled if the parameter <i>Enable communication object "Status switch" 1 bit</i> in the <i>B: Output</i> parameter window is set to <i>Yes</i>. You can parameterize whether the communication object value <i>No, update only, Only after changing</i> or <i>After a change or request</i> is sent on the bus. The communication object value directly indicates the current contact position of the switching relay. The status value can be inverted. Telegram value 1 = relay ON or OFF depending on the parameterization 0 = relay OFF or ON depending on the parameterization</p>				

ABB i-bus[®] KNX

Planning and application

4 Planning and application

In this chapter you will find some tips and application examples for practical use of the device.

4.1 Fan output

In this section, the function charts and application explanations for the fan outputs are explained.

ABB i-bus[®] KNX Planning and application

4.1.1 Fan operation

In fan operation a single phase fan, blower or convector can be controlled. Fans are controlled via a three-stage speed controller. For this purpose, three windings are tapped off of the fan motor. The resulting fan speed is dependent on the tapping selected. With changeover control you must ensure that two contacts are not switched on simultaneously. For control purposes, at least one three-stage changeover switch with zero position is usually used.

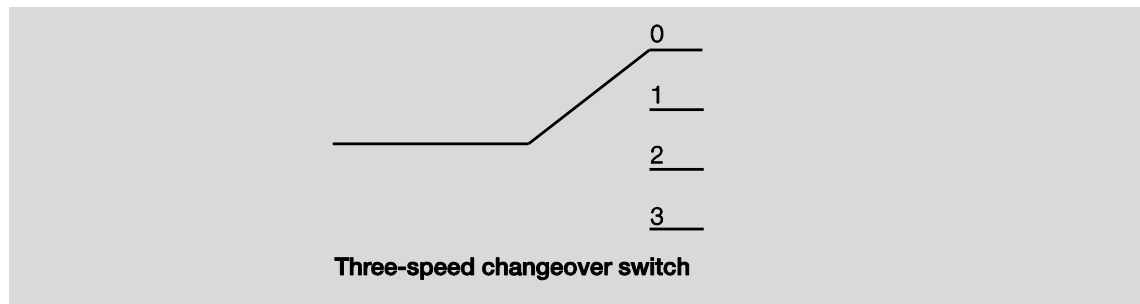

The device is controlled in accordance with the following schematic principle:

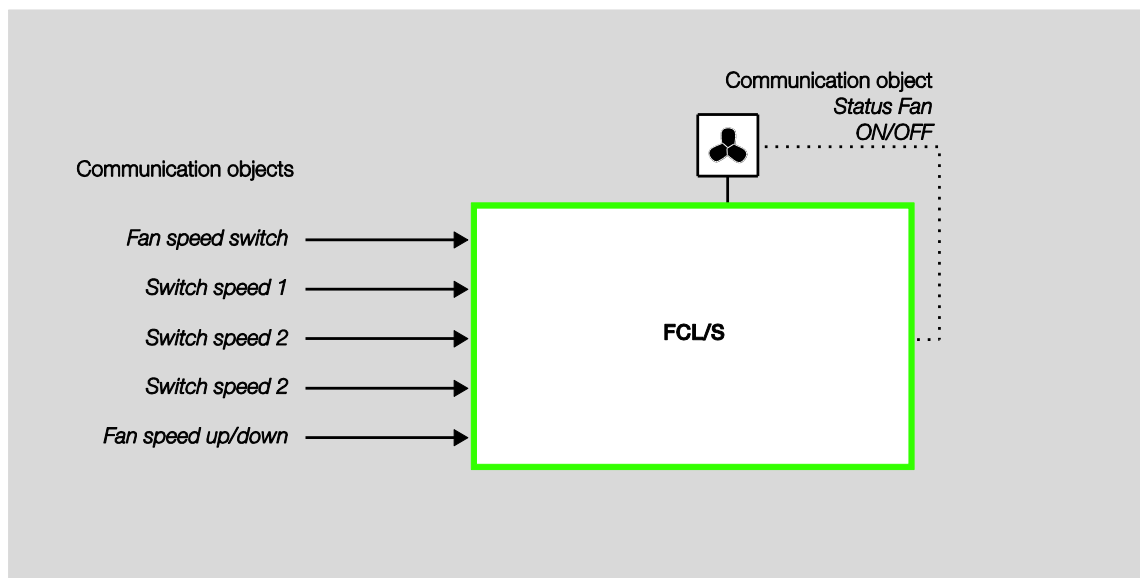

The device's outputs control fan speed with three mutually independent *Switch speed x* ($x = 1, 2, \text{ or } 3$) communication objects.

Alternatively, the fan can be controlled via a 1 byte communication object *Fan speed switch* or via the communication object *Fan speed up/down*.

Some ventilation controls require an additional central switch on mechanism (main switch) in addition to the speed switch. Another output of the device may be used for this. The output must be linked to the communication object *Status Fan ON/OFF*. This will switch on the main switch if at least one fan speed is set. If the fan is OFF (*Status Fan ON/OFF* = 0), the main switch is also switched off.

ABB i-bus[®] KNX

Planning and application

4.1.1.1 Fan with changeover switch

Fans are usually controlled with a changeover switch.

A three-speed fan has the following control table:

	Terminal 2/8	Terminal 3/9	Terminal 4/10
OFF	0	0	0
Fan speed 1	1	0	0
Fan speed 2	0	1	0
Fan speed 3	0	0	1

4.1.1.2 Fan with step switch

In some cases, the fan is controlled via a step switch. A three-speed fan has the following control table:

	Terminal 2/8	Terminal 3/9	Terminal 4/10
OFF	0	0	0
Fan speed 1	1	0	0
Fan speed 2	1	1	0
Fan speed 3	1	1	1

The step switch cannot be switched on rapidly. If, for example, fan speed 3 is to be switched on from the OFF state, fan speeds 1 and 2 must be controlled with the associated dwell times first.

ABB i-bus[®] KNX

Planning and application

4.1.2 Automatic control

With automatic fan control a fan drive is connected directly to the device and switched via three floating contacts. A single-speed, two-speed or three-speed fan can be connected.

The fan speed is set automatically depending on the control value. For example, the following control value ranges can be programmed for the corresponding fan speeds:

<u>Control value</u>	<u>Fan speed</u>
0... 9 %	0 (fan off)
10... 39 %	1
40... 69 %	2
70... 100 %	3

In addition to manual control via the communication objects *Switch speed x*, *Fan speed switch* or *Fan speed up/down*, the blower actuator can also operate in automatic mode together with one or more control values. Communication objects *Control value A* and *Control value B* are available for this, or *Control value* if there is only one input variable.

Automatic mode is enabled in the parameter window *A: Fan* or *CDE: Fan* via the parameter *Enable automatic operation*. The number of assigned communication objects for the control values is defined in the *Automatic control* parameter window.

An automatic operation parameterized in ETS only becomes active after the first download. With a subsequent download, the automatic operating state (active, inactive) is retained as it was before the download. There is however an exception when system properties such as the number of control value inputs, fan control (changeover, step control) or the fan speed count (1/2/3) has been changed. In these cases, automatic mode is activated if it has been enabled in ETS.

Automatic mode is switched off either by a manual control telegram via the communication objects *Switch speed x* ($x = 1, 2, 3$), *Fan speed switch* or *Fan speed up/down*, or if a telegram with the value 0 is received via the communication object *Automatic ON/OFF*.

Automatic mode can be reactivated by the communication object *Automatic ON/OFF*.

Activating one of the four limitations or forced operation does not end automatic operation. By using a range limit (several fan speeds are permissible), a limited automatic control with several fan speeds is possible.

ABB i-bus[®] KNX Planning and application

The following functional diagram shows the relationship between automatic and manual operation of the device.



ABB i-bus[®] KNX

Planning and application

4.1.3 Direct operation

With direct fan control via the ABB i-bus[®], a fan drive is connected directly to the device and switched via three floating contacts. A single-speed, two-speed or three-speed fan can be connected.

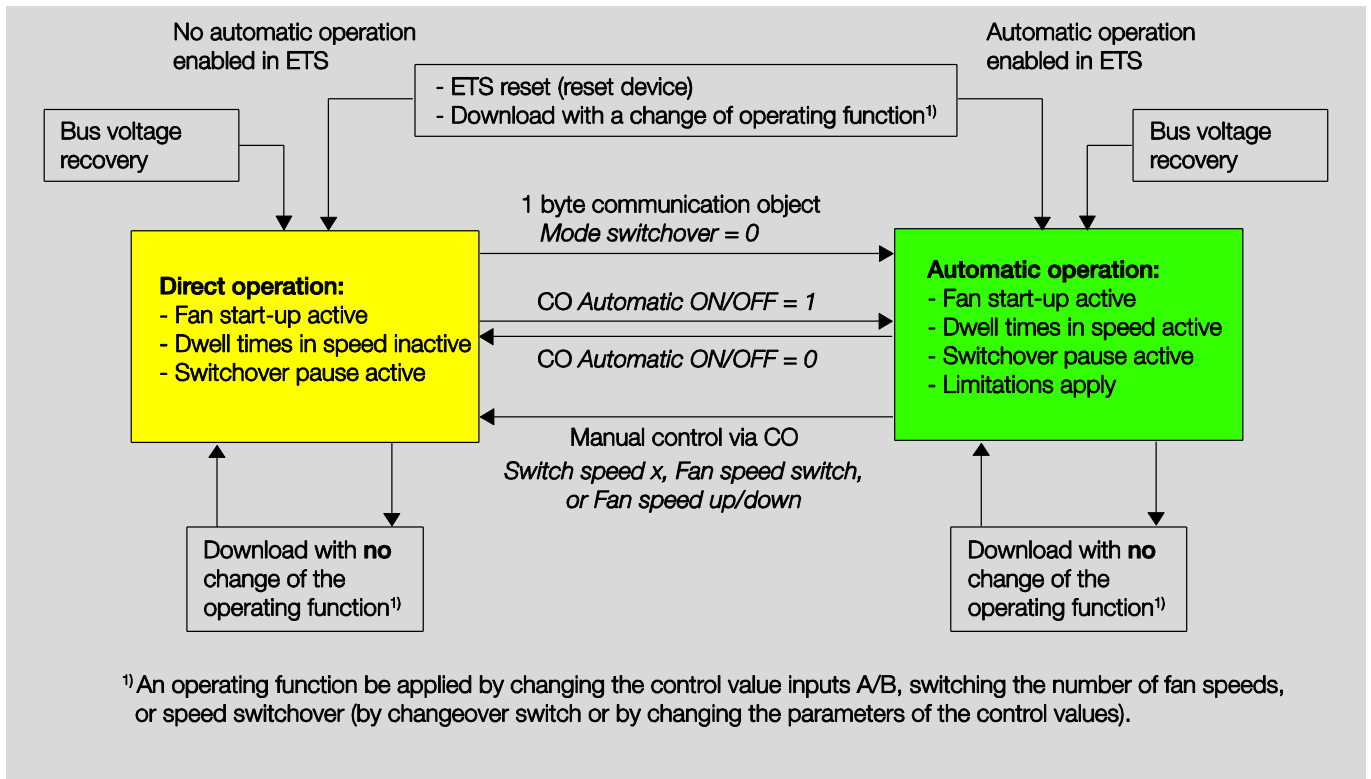
The device sets the fan speed in accordance with a value received via the ABB i-bus[®]. The value is received as a 1 byte value.

1 byte value	Hexadecimal	Binary value bit 76543210	Fan speed
0	00	00000000	0 (OFF)
1	01	00000001	Fan speed 1
2	02	00000010	Fan speed 2
3	03	00000011	Fan speed 3
>3	>03	>00000011	Values greater than 3 are ignored

4.1.4 Switchover between automatic and direct operation

The device can switch between automatic operation and direct operation. The changeover to manual fan control is implemented via a 1 bit value. The fan speed is switched in accordance with the 1 byte value received.

Fan control is changed back to automatic operation if a 1 is received on the respective communication object.

The current status of automatic operation is fed-back via a 1 bit value.

ABB i-bus[®] KNX Planning and application

4.1.5 Speed switching logic

The following illustration shows the speed changeover logic for the device depending on the control values and the parameterized threshold values and hystereses.

The diagram relates to a three-speed fan without parameterized fan limitations. The fan limitations are only relevant after the fan speed has been determined and do not change the flow chart.



ABB i-bus[®] KNX Planning and application

4.1.6 Fan operation functional diagram

The following illustration indicates the sequence in which the fan control functions are processed. Communication objects which lead to the same box have the same priority and are processed in the sequence in which the telegrams are received.

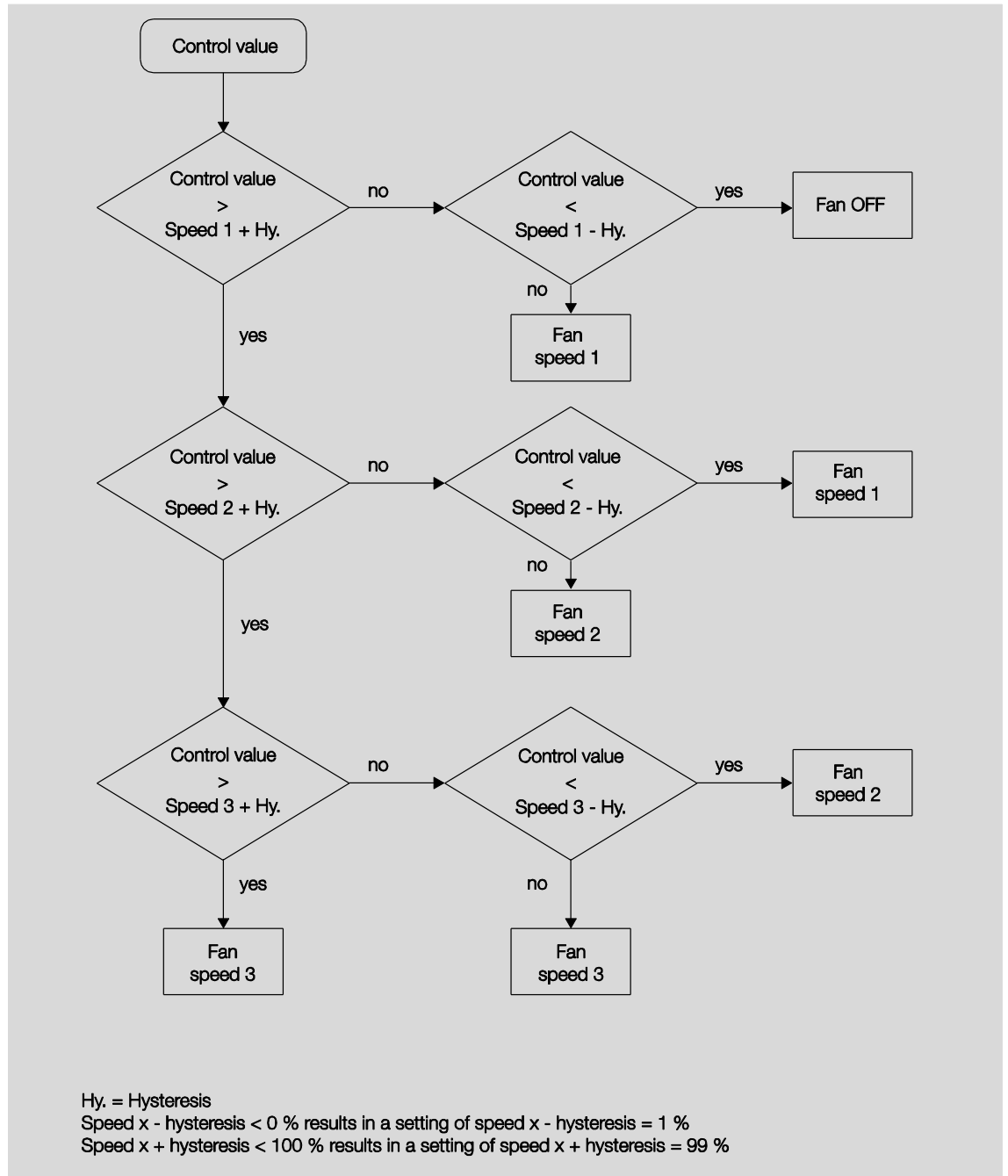

ABB i-bus[®] KNX Planning and application

4.2 Switch output

In this section, the function diagrams and application explanations for the switch outputs are explained.

4.2.1 Function diagram

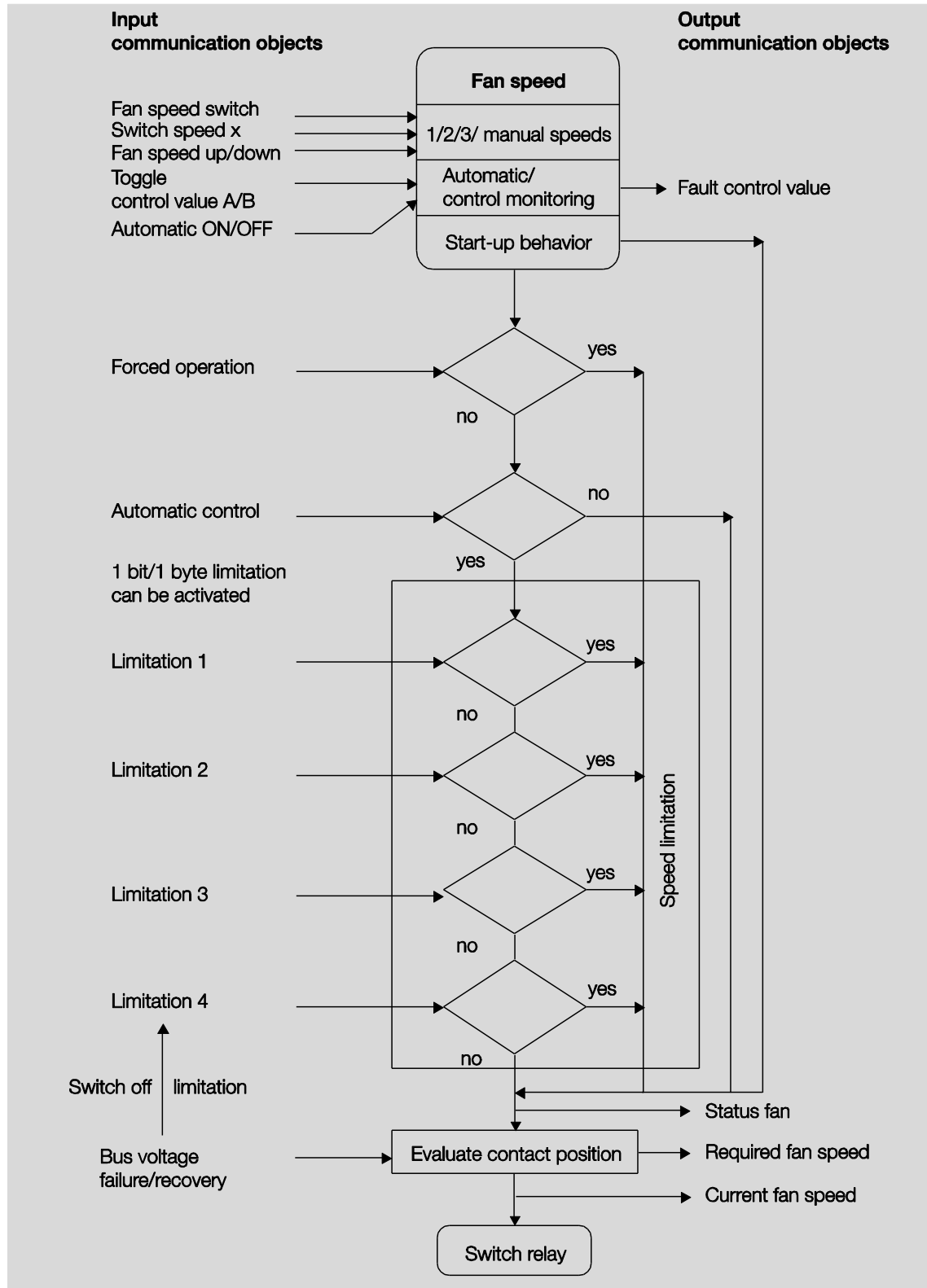
The following illustration indicates the sequence in which the functions are processed. Communication objects which lead to the same box have the same priority and are processed in the sequence in which the telegrams are received.

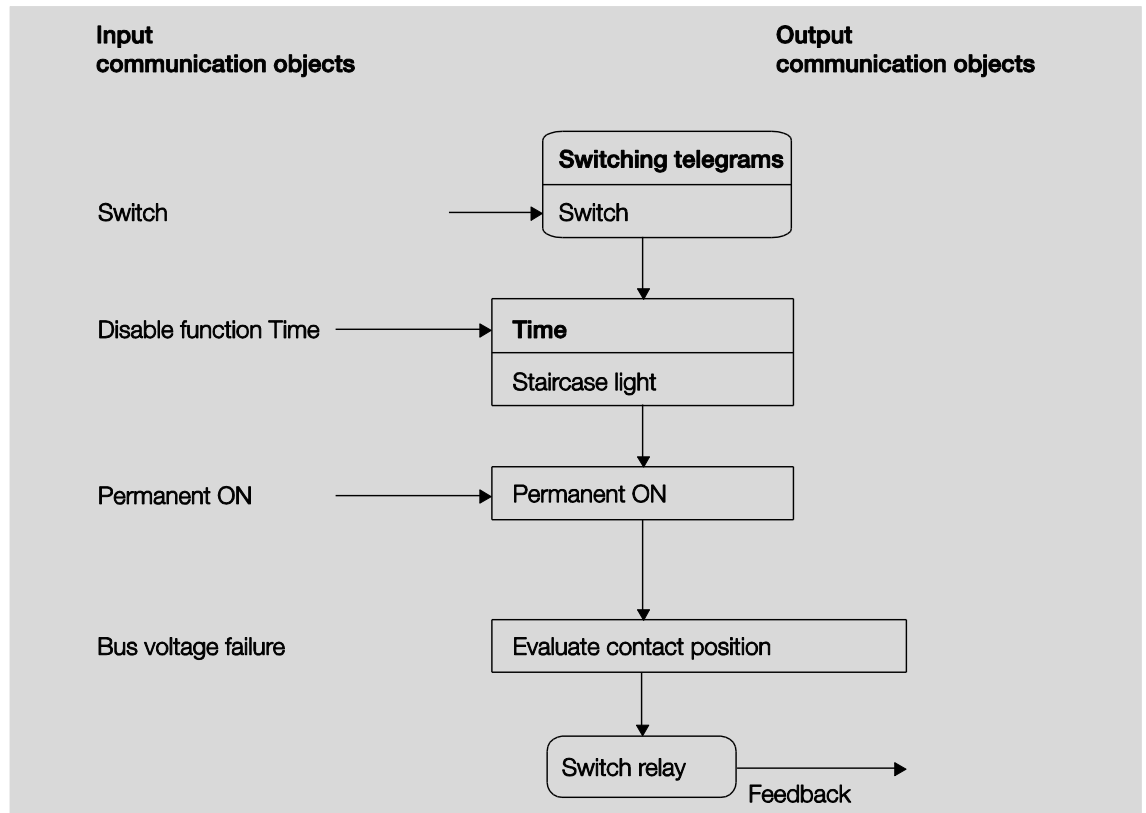

Note

When the communication object *Switch* receives a telegram, the result of that telegram serves as an input signal for the *Time* function. If that function is not disabled, a corresponding switch signal is generated. Subsequently, the switching action is only dependent on the state of the bus voltage. The relay is switched if a switching action allows it.

ABB i-bus[®] KNX Planning and application

4.2.2 Time function

The *Time* function can be enabled (value 0) and disabled (value 1) via the bus (1 bit communication object *Disable function Time*). The output operates without a delay as long as the *Time* function is disabled.

The following functions can be undertaken using the *Time* function:

- Staircase lighting

You can switch, for example, between functions, e.g. function *Staircase lighting* (night time operation) and normal ON/OFF switch function (daytime operation).

4.2.2.1 Staircase lighting

After the staircase lighting time T_{ON} has elapsed, the output switches off automatically. For every telegram with the value 1, the time restarts, except if the parameter *Extending staircase lighting by multiple operation ["pumping up"]* in [Parameter window B: Output - Time](#), p.58 is set to *No* (not retriggerable).

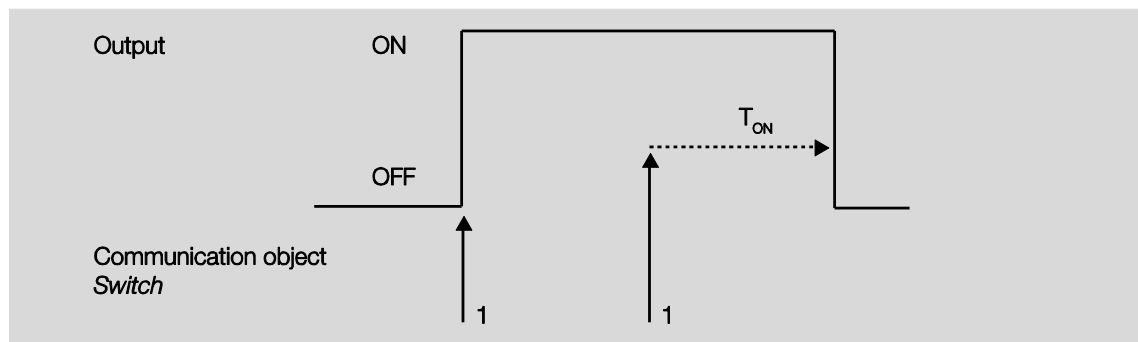

The response is the basic response of the *Staircase lighting* function.

Via "pumping up" – actuation of the push button several times in succession – the user can adapt the staircase lighting to current needs. The maximum duration of the staircase lighting time can be set in the parameters.

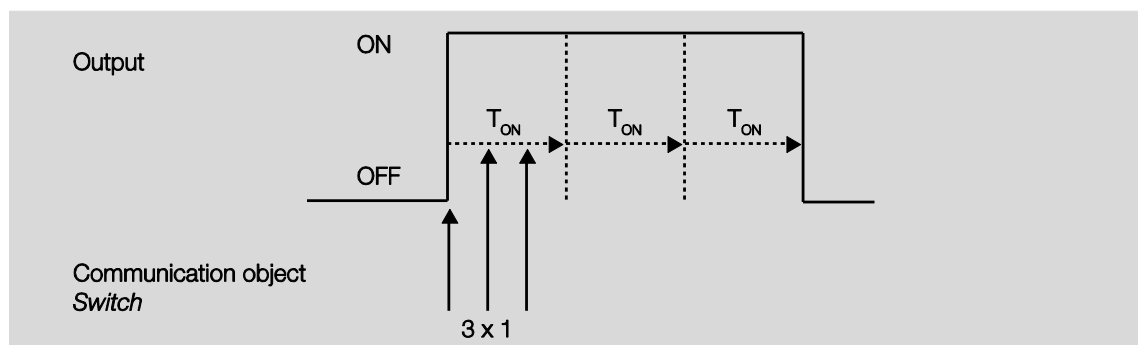

If the device receives a further ON telegram when the staircase lighting is switched on, the staircase lighting time is added to the remaining period.

ABB i-bus[®] KNX Planning and application

4.3 Application example: Switching heating and cooling valves

Besides controlling fans, the additional switch outputs can be used for switching heating and cooling valves. These mechanical outputs are not suitable for regulating valve position, e.g. with pulse-width modulation (PWM). (Please compare the switching cycles in the technical data). But instead, they can be used for opening heating and cooling valves on request.

The following diagram shows a switching example:

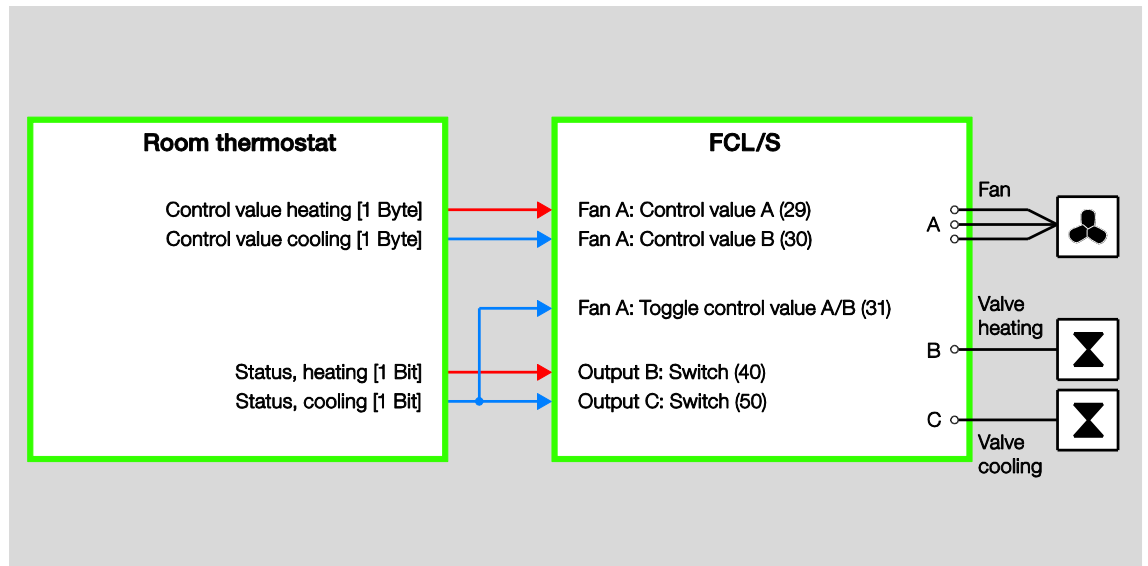

The blower actuator does not have the functions needed for fan coil units, like valve regulation, protection functions and valve purge.

ABB i-bus[®] KNX

Planning and application

4.4 Reaction on bus voltage failure, recovery, download and ETS reset

The way in which the device responds on bus voltage failure or recovery, download and ETS reset are described below.

Important
<p>For system reasons, the device switches the outputs OFF for about 1 second after bus voltage recovery, download or ETS reset. The response is the same after overload, short-circuit and supply voltage recovery.</p> <p>Switch off is not taken into account in the status objects.</p> <p>After switch off, the outputs assume the current state.</p>

4.4.1 Bus voltage failure

Fan or switch actuator response to bus voltage failure can be set.

4.4.2 Bus voltage recovery

- A fan speed value can be predefined for bus voltage recovery. In *Switch actuator* mode, the communication object *Switch* can be written with 0, 1 or *not* written.
- Status communication objects are sent provided that the option *Only after changing* or *After a change or request* has been set.
- The sent delay is only active at bus voltage recovery!

ABB i-bus[®] KNX

Planning and application

4.4.3 ETS reset

What is an ETS reset?

Generally an ETS reset is defined as a reset of the device via ETS. It is initiated in ETS under the menu item *Commissioning* with the function *Reset device*. This stops and restarts the application.

4.4.4 Download

During a download, the output behaves just as it would on bus voltage failure.

Note
After a download with a change, the parameter responds as if there has been an ETS reset. If the application is downloaded again (full download) after a full discharge, the response is the same as after an ETS reset. After the application is removed or after an interrupted download, manual operation no longer functions.

ABB i-bus[®] KNX

Planning and application

4.4.5 Tabular overview of bus voltage recovery, download and ETS reset

Device general

Behavior	On bus voltage recovery	Download	After ETS reset, full download and application update
Transmission and switching delay	Yes (can be parameterized)	None	None
Communication object "In operation"	Sends after send delay. Cycle time commences after initialization.	Cycle time commences after initialization.	Cycle time commences after initialization.

Output: fan

Behavior	On bus voltage recovery	After download	After ETS reset, full download and application update
Status byte	Error bit is reset and set again if necessary	Error bit is reset and set again if necessary	Error bit is reset and set again if necessary
Status messages	Sent if send reaction is set to "Only after changing" or "After a change or request".	Sent if send reaction is set to "Only after changing" or "After a change or request".	Sent if send reaction is set to "Only after changing" or "After a change or request".
Output control	Can be parameterized separately for bus voltage failure and recovery	Unchanged	Off
Start-up behavior	Unchanged	Unchanged	Canceled
Enable/disable communication object "Run-on"	Unchanged	Unchanged	Enabled
Run-on behavior	Stopping time restarts at current speed.	Stopping time restarts at current speed.	Canceled
Forced operation	Unchanged	Unchanged	Canceled
Automatic ON/OFF	Unchanged	Unchanged	On
Control value monitoring in automatic mode	Monitoring time is restarted. Control value fault is reset.	Monitoring time is restarted. Control value fault is reset.	Monitoring time is restarted. Control value fault is reset.
Limitations	Unchanged	Unchanged	Inactive

Output: Switch actuator

Reaction	On bus voltage recovery	After download	After ETS reset, full download and application update
Status messages	Sent if send reaction is set to "Only after changing" or "after a change or request".	Sent if send reaction is set to "Only after changing" or "After a change or request".	Sent if send reaction is set to "Only after changing" or "After a change or request".
Output control	Can be parameterized separately for bus voltage failure and recovery	Unchanged	Off
Staircase lighting time	Continues	Continues	Not active
Disable function Time	Unchanged	Can be parameterized	Not active
Permanent On	Unchanged	Unchanged	Not active

ABB i-bus[®] KNX

Planning and application

4.5

Priorities

Fan

The priorities for telegram processing are defined as follows:

1. Bus voltage failure
2. Forced operation
3. Direct operation
4. Limitation of automatic operation
5. Malfunction of automatic operation
6. Control value automatic operation
7. Bus voltage recovery

Switch Actuator

The priorities for telegram processing are defined as follows:

1. Bus voltage failure
2. Function *Time (Staircase lighting)*
3. Switching telegrams
4. Bus voltage recovery

Note
1 corresponds with the highest priority.

A **Appendix**

A.1 **Scope of delivery**

The blower actuators are supplied together with the following components. The delivered items should be checked against the list below.

- 1 (one) FCL/S 1.6.1.1 or FCL/S 2.6.1.1, MDRC
- 1 (one) set of installation and operating instructions
- 1 (one) bus connection terminal (red/black)

ABB i-bus[®] KNX Appendix

A.3 Ordering details

Short description	Designation	Order No.	bbn 40 16779 EAN	Weight 1 pc. [kg]	Packaging [pcs.]
FCL/S 1.6.1.1	Blower Actuator, 1-fold, 6 A, MDRC	2CDG110163R0011	877886	0.18	1
FCL/S 2.6.1.1	Blower Actuator, 2-fold, 6 A, MDRC	2CDG110164R0011	877879	0.26	1

ABB i-bus[®] KNX Appendix

A.4 Notes

Contact us

ABB STOTZ-KONTAKT GmbH

Eppelheimer Straße 82

69123 Heidelberg, Germany

Telephone: +49 (0)6221 701 607

Fax: +49 (0)6221 701 724

E-mail: knx.marketing@de.abb.com

Further information and local contacts:

www.abb.com/knx

Note

We reserve the right to make technical changes or modify the contents of this document without prior notice.

The agreed properties are definitive for any orders placed. ABB AG shall not be liable for any consequences arising from errors or incomplete information in this document.

We reserve all rights in this document and in the subject matter and illustrations contained therein. Reproduction, transfer to third parties or processing of the content – including sections thereof – is not permitted without prior expressed written permission from ABB AG.

Copyright© 2015 ABB

All rights reserved