

PRODUCT MANUAL

# ABB i-bus<sup>®</sup> KNX

## AC/S 1.x.1

## Application Controller

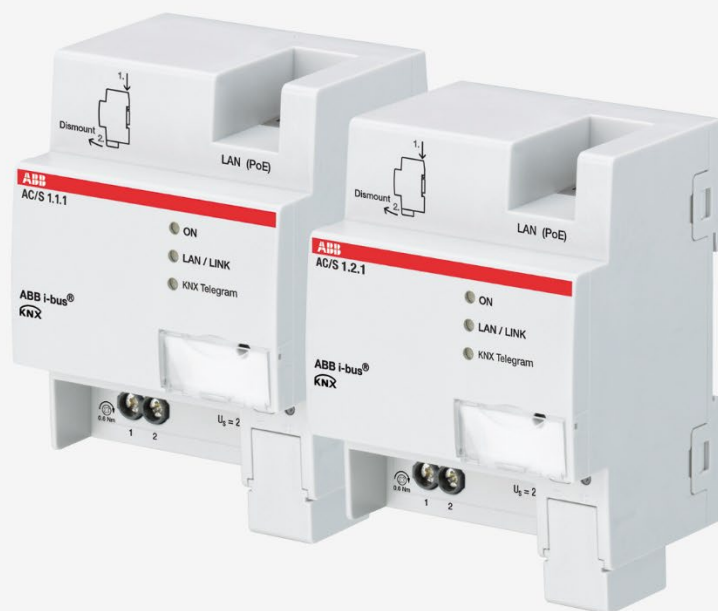



# ABB i-bus<sup>®</sup> KNX

## Contents

### Contents

Page

<b>1</b>	<b>General .....</b>	<b>9</b>
1.1	Using the product manual.....	9
1.2	Legal disclaimer.....	9
1.3	Explanation of symbols.....	9
<b>2</b>	<b>Safety .....</b>	<b>11</b>
2.1	General safety instructions.....	11
2.2	Proper use.....	11
2.3	Cyber security (network security).....	11
2.4	Preventing access to the different media.....	11
2.5	Twisted pair cabling.....	12
2.6	IP cabling inside the building.....	12
2.7	Connection to the Internet.....	13
2.8	Open IP network ports.....	13
<b>3</b>	<b>Product overview .....</b>	<b>14</b>
3.1	Product overview.....	14
3.2	Ordering details.....	14
3.3	AC/S 1.1.1 Application Controller, Basic.....	15
3.3.1	Dimension drawing.....	16
3.3.2	Connection diagram.....	17
3.3.3	Operating and display elements.....	18
3.3.4	Technical data.....	19
3.3.4.1	General technical data.....	19
3.3.4.2	Device type.....	20
3.3.4.3	Description of inputs and outputs.....	21
3.4	AC/S 1.2.1 Application Controller, BACnet.....	22
3.4.1	Dimension drawing.....	23
3.4.2	Connection diagram.....	24
3.4.3	Operating and display elements.....	25
3.4.4	Technical data.....	26
3.4.4.1	General technical data.....	26
3.4.4.2	Device type.....	27
3.4.4.3	Description of inputs and outputs.....	28

# ABB i-bus<sup>®</sup> KNX

## Contents

<b>4</b>	<b>Function .....</b>	<b>29</b>
4.1	Overview .....	29
4.2	Functional overview .....	29
4.2.1	Automation functions .....	30
4.2.2	Web user interface .....	30
4.2.3	BACnet .....	31
4.2.4	KNX .....	31
4.3	Functions of the inputs .....	32
4.4	Functions of the outputs .....	32
4.5	Integration in the i-bus <sup>®</sup> Tool.....	32
4.6	Special operating states .....	33
4.6.1	Reaction on bus and supply voltage failure, recovery, download and ETS reset.....	33
4.6.1.1	Bus voltage failure .....	33
4.6.1.2	Bus voltage recovery .....	33
4.6.1.3	Supply voltage failure and recovery .....	33
4.6.1.4	ETS reset.....	34
4.6.1.5	Download.....	34
4.6.2	Unloading ETS application program .....	35
4.6.3	Unloading ETS physical address & application program .....	35
4.6.4	Device restart.....	35
4.6.5	Factory settings .....	35
4.7	Data point types.....	36
<b>5</b>	<b>Mounting and installation.....</b>	<b>37</b>
5.1	Information about mounting .....	37
5.2	Mounting on DIN rail .....	38
5.3	Supplied state .....	38
<b>6</b>	<b>Commissioning .....</b>	<b>39</b>
6.1	Prerequisites for commissioning .....	39
6.2	Commissioning overview .....	40
6.3	Assignment of the physical address .....	41
6.3.1	Network settings .....	41
6.4	Software/application .....	43
6.5	Device Configuration App (DCA) .....	44
6.5.1	Overview.....	44
6.5.2	ASM library .....	45
6.5.3	Structure .....	45
6.5.4	Workspace.....	46
6.5.5	ASM properties bar .....	46
6.5.6	Menu bar.....	47
6.5.7	Linking view .....	49
6.5.8	Copying, cutting and pasting.....	52
6.5.9	Undoing and redoing .....	54
6.5.10	Project verification .....	55
6.5.11	Download reaction .....	55
6.5.12	Copying, exchanging and converting.....	55

# ABB i-bus<sup>®</sup> KNX

## Contents

<b>7</b>	<b>Parameters .....</b>	<b>57</b>
7.1	General.....	57
7.2	Global device settings .....	58
7.2.1	ETS parameters .....	58
7.2.2	DCA device settings .....	59
7.2.2.1	IP network parameter page .....	59
7.2.2.2	KNX parameter page.....	59
7.2.2.3	BACnet parameter page.....	60
7.2.2.4	WebUI – Users parameter page.....	62
7.2.2.5	Clock parameter page .....	63
7.2.3	Web user interface device settings.....	64
7.2.3.1	System tools parameter page.....	64
7.2.3.2	Firmware update parameter page .....	65
7.2.3.3	KNX Programming mode parameter page .....	65
7.2.3.4	Monitor mode parameter page .....	66
7.2.3.5	SSH access parameter page.....	66
7.2.3.6	Log settings parameter page .....	67
7.2.3.7	SSL certificate parameter page .....	68
7.2.3.8	Connection settings parameter page.....	71
7.3	Global ASM settings .....	72
7.3.1	General.....	72
7.3.2	BACnet .....	73
7.3.3	WebUI .....	75
7.3.4	Info .....	75
7.3.5	Help .....	75
7.4	Automation ASM.....	76
7.4.1	General.....	76
7.4.2	Settings .....	76
7.4.3	Sockets.....	140
7.4.4	Group objects .....	140
7.4.5	BACnet objects.....	140
7.4.6	Web user interface .....	141
7.5	Value ASM.....	142
7.5.1	General.....	142
7.5.2	Settings .....	142
7.5.3	Sockets.....	176
7.5.4	Group objects .....	177
7.5.5	BACnet objects.....	178
7.5.6	WebUI .....	179
7.6	Link ASM .....	180
7.6.1	General.....	180
7.6.2	Settings .....	180
7.6.3	Sockets.....	181
7.6.4	Group objects .....	181
7.6.5	BACnet objects.....	181
7.6.6	WebUI .....	182

# ABB i-bus® KNX

## Contents

7.7	Room ASM .....	183
7.7.1	General .....	183
7.7.2	Settings .....	184
7.7.3	Sockets .....	195
7.7.4	Group objects .....	203
7.7.5	BACnet objects .....	218
7.7.6	WebUI .....	227
7.8	Room setpoint temperatures ASM .....	229
7.8.1	General .....	229
7.8.2	Settings .....	230
7.8.3	Sockets .....	234
7.8.4	Group objects .....	236
7.8.5	BACnet objects .....	238
7.8.6	WebUI .....	240
7.9	Heating distribution circuit ASM .....	242
7.9.1	General .....	242
7.9.2	Settings .....	243
7.9.3	Sockets .....	260
7.9.4	Group objects .....	270
7.9.5	BACnet objects .....	276
7.9.6	WebUI .....	286
7.10	Heat generator ASM .....	294
7.10.1	General .....	294
7.10.2	Settings .....	295
7.10.3	Sockets .....	311
7.10.4	Group objects .....	318
7.10.5	BACnet objects .....	322
7.10.6	WebUI .....	330
7.11	Cooling distribution circuit ASM .....	338
7.11.1	General .....	338
7.11.2	Settings .....	339
7.11.3	Sockets .....	348
7.11.4	Group objects .....	355
7.11.5	BACnet objects .....	361
7.11.6	WebUI .....	368
7.12	Chiller ASM .....	374
7.12.1	General .....	374
7.12.2	Settings .....	375
7.12.3	Sockets .....	383
7.12.4	Group objects .....	388
7.12.5	BACnet objects .....	392
7.12.6	WebUI .....	397
7.13	Heating/cooling changeover ASM .....	403
7.13.1	General .....	403
7.13.2	Settings .....	403
7.13.3	Sockets .....	406
7.13.4	Group objects .....	407
7.13.5	BACnet objects .....	408
7.13.6	WebUI .....	409

# ABB i-bus<sup>®</sup> KNX

## Contents

7.14	Operating mode Scheduler WebUI ASM .....	410
7.14.1	General.....	410
7.14.2	Settings .....	410
7.14.3	Sockets.....	411
7.14.4	Group objects .....	411
7.14.5	BACnet objects.....	412
7.14.6	WebUI .....	413
7.15	ON/OFF Scheduler WebUI ASM .....	421
7.15.1	General.....	421
7.15.2	Settings .....	421
7.15.3	Sockets.....	422
7.15.4	Group objects .....	422
7.15.5	BACnet objects.....	423
7.15.6	WebUI .....	424
7.16	Temperature Scheduler WebUI ASM .....	432
7.16.1	General.....	432
7.16.2	Settings .....	432
7.16.3	Sockets.....	433
7.16.4	Group objects .....	433
7.16.5	BACnet objects.....	434
7.16.6	WebUI .....	435
7.17	Operating mode Scheduler BACnet ASM.....	443
7.17.1	General.....	443
7.17.2	Settings .....	443
7.17.3	Sockets.....	445
7.17.4	Group objects .....	445
7.17.5	BACnet objects.....	446
7.17.6	WebUI .....	447
7.18	ON/OFF Scheduler BACnet ASM.....	448
7.18.1	General.....	448
7.18.2	Settings .....	448
7.18.3	Sockets.....	450
7.18.4	Group objects .....	450
7.18.5	BACnet objects.....	451
7.18.6	WebUI .....	452
7.19	Temperature Scheduler BACnet ASM.....	453
7.19.1	General.....	453
7.19.2	Settings .....	453
7.19.3	Sockets.....	455
7.19.4	Group objects .....	455
7.19.5	BACnet objects.....	456
7.19.6	WebUI .....	457
7.20	Trend ASM .....	458
7.20.1	General.....	458
7.20.2	Settings .....	459
7.20.3	Sockets.....	466
7.20.4	Group objects .....	467
7.20.5	BACnet objects.....	467
7.20.6	Web user interface .....	468

# ABB i-bus<sup>®</sup> KNX

## Contents

<b>8</b>	<b>Group objects .....</b>	<b>471</b>
8.1	Summary of group objects .....	471
8.2	Group objects, general .....	472
<b>9</b>	<b>Operation .....</b>	<b>473</b>
9.1	Manual operation .....	473
9.2	Web user interface .....	474
9.2.1	Menu bar .....	474
9.2.2	Building dashboard .....	475
9.2.3	Navigation menu .....	475
9.2.4	ASM detailed view .....	475
<b>10</b>	<b>Maintenance and cleaning .....</b>	<b>477</b>
10.1	Maintenance .....	477
10.2	Cleaning .....	477
10.3	Software update .....	478
10.4	Support .....	478
<b>11</b>	<b>Disassembly and disposal .....</b>	<b>479</b>
11.1	Removal .....	479
11.2	Environment .....	480
11.3	Deleting data .....	480
<b>12</b>	<b>Planning and application .....</b>	<b>481</b>
12.1	Application examples .....	481
12.2	Several devices per system .....	481
<b>13</b>	<b>Appendix .....</b>	<b>483</b>
13.1	Scope of delivery .....	483
13.2	Notes .....	484



### 1 General

#### 1.1 Using the product manual

This manual provides detailed technical information relating to the function, installation and programming of the ABB i-bus<sup>®</sup> KNX device.

#### 1.2 Legal disclaimer

We reserve the right to make technical changes or modify the contents of this document without prior notice.

The agreed properties are definitive for any orders placed. ABB AG does not accept any responsibility whatsoever for potential errors or possible lack of information in this document.

We reserve all rights in this document and in the subject matter and illustrations contained therein. Reproduction, transfer to third parties or processing of the content – including sections thereof – is not permitted without prior express written permission from ABB AG.

The product makes use of open source software. You must accept the license agreement before using the software for the first time.

Copyright© 2024 ABB AG

All rights reserved

#### 1.3 Explanation of symbols

---

1.	Instructions in specified sequence
2.	
▶	Individual actions
a)	Priorities
1)	Processes run by the device in a specific sequence
•	1st-level list
○	2nd-level list

---

Table 1: Explanation of symbols

Notes and warnings are represented as follows in this manual:



**DANGER –**

This symbol is a warning about electrical voltage and indicates high-risk hazards that will definitely result in death or serious injury unless avoided.



**DANGER –**

Indicates high-risk hazards that will definitely result in death or serious injury unless avoided.



**WARNING –**

Indicates medium-risk hazards that could result in death or serious injury unless avoided.



**CAUTION –**

Indicates low-risk hazards that could result in slight or moderate injury unless avoided.



**ATTENTION –**

Indicates a risk of malfunctions or damage to property and equipment, but with no risk to life and limb.

**Example:**

For use in application, installation and programming examples

**Note**

For use in tips on usage and operation

## 2 Safety

### 2.1 General safety instructions

- ▶ Protect the device from moisture, dirt and damage during transport, storage and operation.
- ▶ Operate the device only within the specified technical data.
- ▶ Operate the device only in a closed housing (distribution board).
- ▶ Mounting and installation must be carried out by qualified electricians.
- ▶ Disconnect the device from the supply of electrical power before mounting.

### 2.2 Proper use

The device must be installed centrally in an electrical distribution board.

The device is a modular DIN rail component for quick installation in distribution boards on 35 mm mounting rails according to EN 60715.

### 2.3 Cyber security (network security)

The industry is increasingly faced with cyber security risks. To increase the stability, security and robustness of its solutions, ABB has introduced official robustness tests for Internet security as part of the product development process.

In addition, the information below includes guidelines and mechanisms that you can use to improve the security of KNX systems.

### 2.4 Preventing access to the different media

The basis for any protection concept is the careful shielding of the system against unauthorized access. Only authorized persons (installers, janitors and users) should have physical access to a KNX system. The critical points of every KNX medium must be protected as well as possible during planning and installation.

In general, applications and devices should be permanently installed to prevent their easy removal and in this way prevent access to the KNX system for unauthorized persons. Sub-distributions with KNX devices should be closed, or in rooms to which only authorized persons have access.

### 2.5 Twisted pair cabling

- ▶ The ends of KNX twisted pair cables should not be visible or protrude from the wall either inside or outside the building.
- ▶ If available, use the anti-theft devices on the application modules.
- ▶ Bus cables outdoors represent an elevated risk. Ensure that physical access to KNX twisted pair cables is especially difficult here.
- ▶ For extra security, devices installed in areas with limited protection (outdoor areas, underground parking lots, restrooms, etc.) can be designed as a separate line. Enabling the filter tables in the line coupler (KNX only) prevents attackers from gaining access to the whole system.

### 2.6 IP cabling inside the building

For building automation, use a separate LAN or WLAN network with its own hardware (routers, switches etc.).

Regardless of the KNX system, apply the usual security mechanisms for IP networks. These are examples:

- MAC filter
- Encryption of wireless networks
- Usage of strong passwords and protection of these against access by unauthorized persons

#### Note

The device cannot be reached during IP, TCP or UDP flooding (access from the internet). To prevent this reaction, set a data rate limit at network level.  
Please discuss this with your network administrator.

## 2.7 Connection to the Internet

KNXnet/IP routing and KNXnet/IP tunneling use unencrypted data transfer and is therefore not intended for use on the public internet. For this reason router ports in the direction of the internet must not be opened: this action will ensure KNX communication is not visible on the internet.

Systems can be accessed via the internet in the following ways:

- Access to KNX installations via VPN connections. However, this requires a router with VPN server functionality or a server.
- Use of manufacturer-specific solutions or visualizations, e.g. access via https.

## 2.8 Open IP network ports

The device uses the following network ports for data communication in the IP network. It is to be ensured that only authorized systems have access to these network ports.

Port	Limitation	Protocol	Remark
27360 TCP	20/minute	SSH	Only if SSH access has been activated
1900 TCP	15/second	i-bus <sup>®</sup> Tool	
80, 443 TCP	15/second	http, https	WebUI
123 UDP	20/second	NTP	Only if NTP is activated
47808 UDP	30/second	BACnet	Only if BACnet is activated. The port can be changed.
3671 TCP+UDP	30/second	KNX	For the KNX download
2403 TCP	30/second	Automation ASM	Monitor mode. Only if access has been activated.

Table 2: Open IP network ports

# ABB i-bus<sup>®</sup> KNX

## Product Overview

### 3 Product overview

#### 3.1 Product overview

The devices are modular DIN rail component (MDRC) in the pro *M* design. The module width of the devices is 4 space units. The devices are designed for installation in distribution boards on 35 mm mounting rails.

The devices are powered by the bus and require an additional supply voltage, either 24 V DC or Power over Ethernet (PoE).

The device connects to the ABB i-bus<sup>®</sup> KNX via the front bus connection terminal.

The software application Engineering Tool Software (ETS) is used for physical address assignment and for setting the parameters.

The device is ready for operation after connecting the bus voltage and the supply voltage.

Abbreviation	Description
A	Application
C	Controller
/S	MDRC
X	1 = Application
X	1 = KNX
	2 = KNX + BACnet
X	X = Version number (x = 1, 2 etc.)

Table 3: Product name description

#### 3.2 Ordering details

Description	MB	Type	Order No.	Packaging unit [pcs.]	Weight 1 pc. [g]
Application Controller, Basic	4	AC/S 1.1.1	2CDG110205R0011	1	192
Application Controller, BACnet	4	AC/S 1.2.1	2CDG110206R0011	1	192

Table 4: Ordering details

# ABB i-bus® KNX Product Overview

## 3.3 AC/S 1.1.1 Application Controller, Basic



Fig. 1: AC/S 1.1.1 device illustration

Automation controller with pre-defined automation modules for comprehensive heating, ventilation and air conditioning automation (HVAC automation). For use from central systems to room automation, supports the achievement of energy efficiency goals such as EN 15232.

The device contains pre-defined application-specific automation modules (ASM) for the most common areas of application, for instance the calculation of heat demand, trends or schedulers. You can create your own automation modules using a graphic logic editor.

The device has a web user interface for the display of data and operation; this interface is generated automatically.

Commissioning is undertaken entirely in ETS version 5.6.5 or later. Additional external software is not required. The device has a KNX TP connection and requires a supply voltage of 24 V DC or PoE for operation.

2CDC071027F0017

# ABB i-bus<sup>®</sup> KNX Product Overview

## 3.3.1

### Dimension drawing

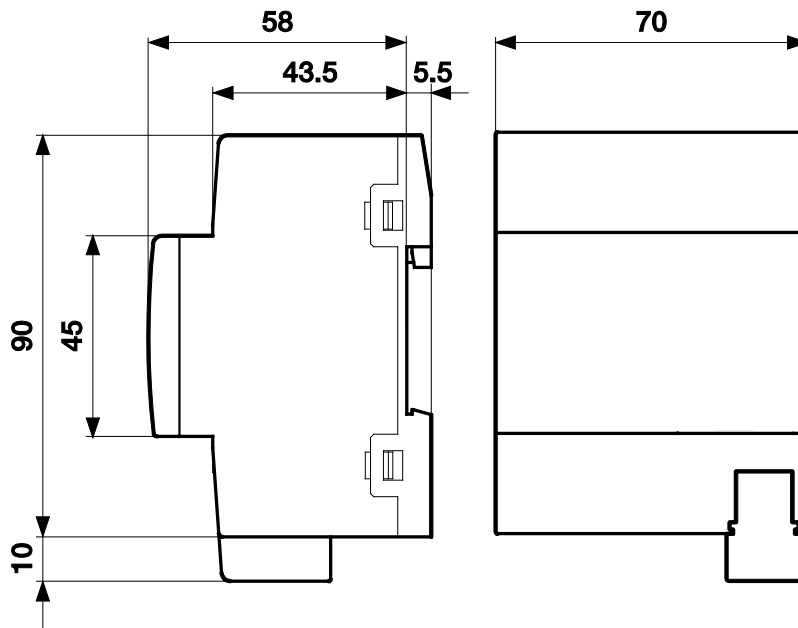

Fig. 2: Dimension drawing

2CDC072033F0015



# ABB i-bus® KNX

## Product Overview

### 3.3.2 Connection diagram

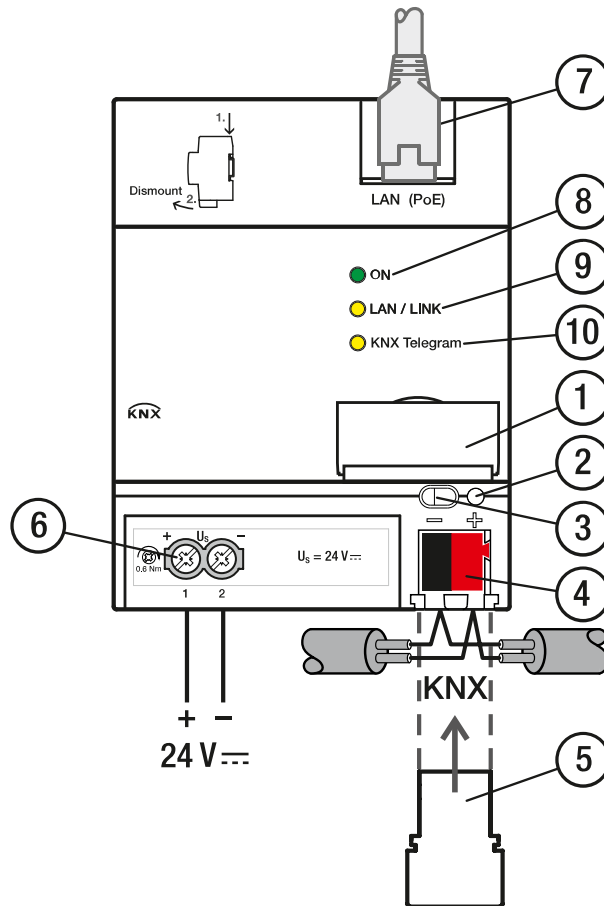

Fig. 3: Connection diagram

#### Legend

- |   |                           |    |                               |
|---|---------------------------|----|-------------------------------|
| 1 | Label carrier             | 6  | Power supply connection $U_s$ |
| 2 | KNX programming LED (red) | 7  | Ethernet/LAN connection       |
| 3 | KNX programming button    | 8  | On LED (green)                |
| 4 | KNX connection            | 9  | LAN/LINK LED (yellow)         |
| 5 | Cover cap                 | 10 | KNX telegram LED (yellow)     |

2CDC072062F0017

# ABB i-bus® KNX

## Product Overview

### 3.3.3

#### Operating and display elements





Button/LED	Description	LED indicator
	Assignment of the physical KNX address	On: Device is in KNX programming mode
	ON	Off: No supply voltage (24 V or PoE) available On: System initialized Flashing slowly (1 Hz): System starting up Flashing quickly (4 Hz): Error
	LAN/LINK	On: Supply voltage and Ethernet connection available Flickering: Data traffic via LAN
	KNX telegram	On: Supply voltage and KNX connection available Flickering: Data traffic via KNX
	Reset (behind label carrier)	Press for less than 2 seconds: no reaction. Press for 2 to 10 seconds: device restart. Retains configuration and last states. Press for more than 10 seconds: factory reset. Deletes configuration and all states.

Table 5: Operating and display elements

#### Note

Device restart and factory reset are only possible if the bus voltage and supply voltage are applied.

#### Note

A firmware update cannot be undone using the factory reset.

# ABB i-bus<sup>®</sup> KNX

## Product Overview

### 3.3.4 Technical data

#### 3.3.4.1 General technical data

Supply	Bus voltage	21...32 V DC
	Current consumption, bus	< 12 mA
	Power loss, bus	Maximum 250 mW
	Power loss, device	Maximum 3 W
	Supply voltage U <sub>s</sub>	24 V DC (+20 % / -15 %) or PoE (IEEE 802.3af class 2)
	Current consumption, supply voltage	90 mA typical 120 mA peak current
KNX connection	KNX connection	0.25 W
	KNX current consumption	< 10 mA
	Connections	KNX
Connections	Supply voltage	Via bus connection terminal
	LAN	Via screw terminals 0.2...2.5 mm <sup>2</sup> fine-wire 0.2...4 mm <sup>2</sup> solid RJ45 connector for 10/100BaseT IEEE 802.3 networks, autosensing
Degree of protection and protection class	Degree of protection	IP 20 according to EN 60529
	Protection class	II according to EN 61140
Isolation category	Overvoltage category	III according to EN 60664-1
	Pollution degree	II according to EN 60664-1
SELV	KNX safety extra low voltage	SELV 30 V DC
Temperature range	Operation	-5...+45 °C
	Transport	-25...+70 °C
	Storage	-25...+55 °C
Ambient conditions	Maximum air humidity	93 %, no condensation allowed
	Atmospheric pressure	Atmosphere up to 2,000 m
Design	Modular DIN rail component (MDRC)	Modular installation device
	Design	pro M
	Housing/color	Plastic, halogen free, gray
Dimensions	Dimensions	90 x 70 x 64 mm (H x W x D)
	Mounting width in space units	4x 17.5 mm modules
	Mounting depth	68 mm
Mounting	35 mm mounting rail	According to EN 60715
	Mounting position	Any
	Weight	0.192 kg
Approvals	Fire classification	Flammability V-0 as per UL94
	KNX certification	According to EN 50090-1, -2
	Certification	According to EN 60669
	CE marking	In accordance with the EMC and Low Voltage Directives

Table 6: Technical data AC/S 1.1.1

# ABB i-bus® KNX

## Product Overview

### 3.3.4.2

#### Device type

Device type	Application Controller	AC/S 1.1.1
	Application	HVAC application/...*
	Maximum number of KNX group objects	2000
	Maximum number of KNX group address assignments	16000
	Maximum number of application-specific automation modules (ASM)	500
	• Of which schedulers	15
	• Of which central HVAC	15
	Maximum number of trends	50 values for up to 3 years
	Automation ASM	
	• Maximum number of logic elements	1000
	• Maximum number of sockets	200
	• Maximum number of web user interface I/O	30
	Maximum number of web user interface accesses	5

\* ... = Current version number of the application. Please refer to the software information on our homepage.

Table 7: Device type AC/S 1.1.1

#### Note

ETS and the current version of the device application are required for programming. The latest version of the application and corresponding software information are available for download from [www.abb.com/knx](http://www.abb.com/knx). After import into ETS, the application appears in the *Catalogs* window under *Manufacturers/ABB/Heating Ventilation Air conditioning/Automation Controller*. In addition to the ETS application, you will require ETS DCA "ABB AC/S" for commissioning; this can be obtained free of charge from the KNX online shop. The device does not support the locking function of a KNX device in ETS. If you use a *BCU code* to inhibit access to all the project devices, it has no effect on this device. Data can still be read and programmed.

#### Note

The application "HVAC Application/1.0" and the DCA "ABB AC/S" are supported in ETS 5 only from version 5.6.5. Earlier versions are not supported.

# ABB i-bus<sup>®</sup> KNX

## Product Overview

### 3.3.4.3 Description of inputs and outputs

#### 3.3.4.3.1 Supply voltage input 24 V DC

Only a DC voltage of 24 V is allowed to be connected to the input for the supply voltage. We recommend using an NT/S power supply from our range.



#### **CAUTION**

The supply voltage must be 24 V DC, or the device is supplied via PoE (Power over Ethernet) according to IEEE 802.3af Class 2.

Connecting the device to 230 V may destroy it!

#### 3.3.4.3.2 KNX connection

The supplied bus connection terminal is used to connect to the KNX bus.

#### 3.3.4.3.3 LAN connection

The device connects to the network via an Ethernet RJ45 interface for LAN networks. The network interface can be operated at a transmission speed of 10/100 Mbit/s. Network activity is indicated by the LAN/LINK LED on the front of the device.

The device features an autosensing function and sets the baud rate (10 or 100 Mbit) automatically.

## 3.4 AC/S 1.2.1 Application Controller, BACnet



Fig. 4: AC/S 1.2.1 device illustration

Automation controller with pre-defined automation modules for comprehensive heating, ventilation and air conditioning automation (HVAC automation). For use from central systems to room automation, supports the achievement of energy efficiency goals such as EN 15232.

The device contains pre-defined application-specific automation modules (ASM) for the most common areas of application, for instance the calculation of heat demand, trends or schedulers. You can create your own automation modules using a graphic logic editor.

The device has a web user interface for the display of data and operation, this interface is generated automatically, as well as an integrated BACnet/IP gateway for the connection of the KNX system to the building control system and other higher level BACnet systems for the bidirectional exchange of data between KNX and BACnet.

Commissioning is undertaken entirely in ETS version 5.6.5 or later. Additional external software is not required. The device has a KNX TP connection and requires a supply voltage of 24 V DC or PoE for operation.

2CDC071028F0017

# ABB i-bus<sup>®</sup> KNX Product Overview

## 3.4.1

### Dimension drawing

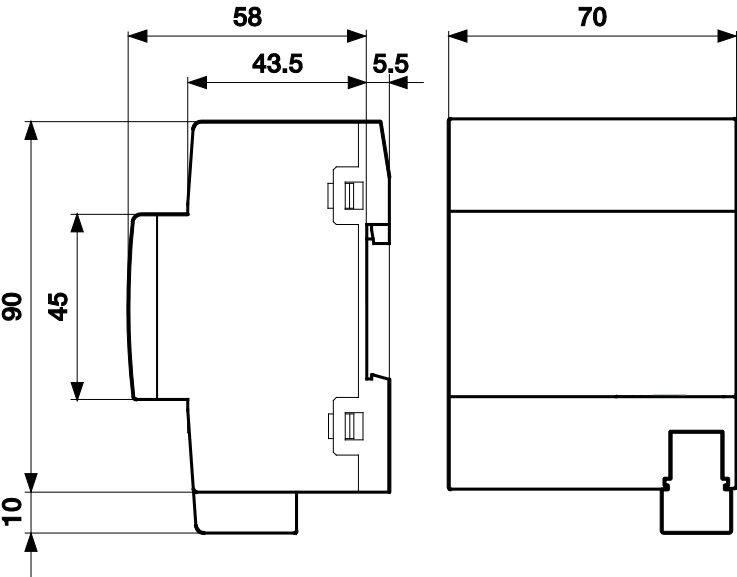

Fig. 5: Dimension drawing

2CDC072033F0015

# ABB i-bus® KNX

## Product Overview

### 3.4.2 Connection diagram

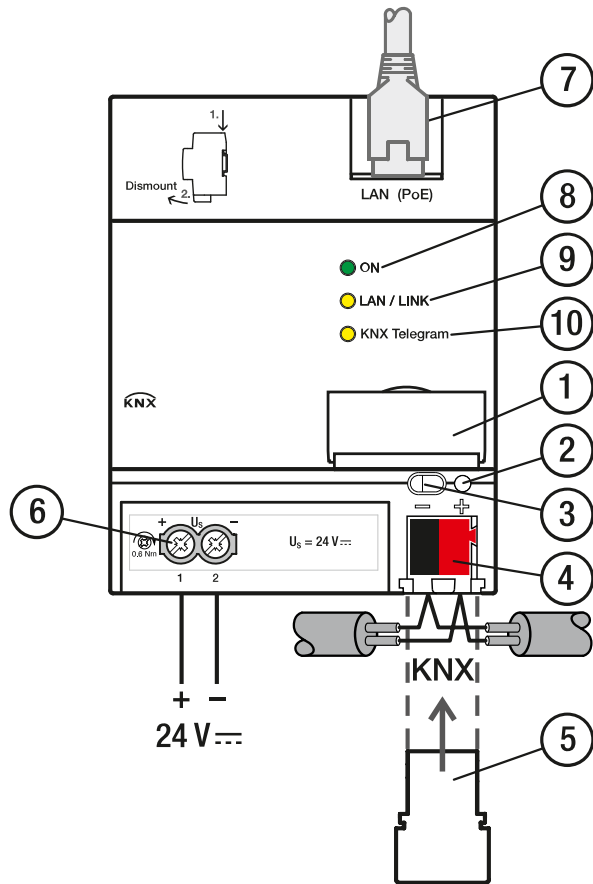

Fig. 6: Connection diagram

#### Legend

- |   |                           |    |                               |
|---|---------------------------|----|-------------------------------|
| 1 | Label carrier             | 6  | Power supply connection $U_s$ |
| 2 | KNX programming LED (red) | 7  | Ethernet/LAN connection       |
| 3 | KNX programming button    | 8  | On LED (green)                |
| 4 | KNX connection            | 9  | LAN/LINK LED (yellow)         |
| 5 | Cover cap                 | 10 | KNX telegram LED (yellow)     |

2CDC072062F0017



# ABB i-bus<sup>®</sup> KNX

## Product Overview

### 3.4.3

#### Operating and display elements





Button/LED	Description	LED indicator
	Assignment of the physical KNX address	On: Device is in KNX programming mode
	ON	Off: No supply voltage (24 V or PoE) available On: System initialized Flashing slowly (1 Hz): System starting up Flashing quickly (4 Hz): Error
	LAN/LINK	On: Supply voltage and Ethernet connection available Flickering: Data traffic via LAN
	KNX telegram	On: Supply voltage and KNX connection available Flickering: Data traffic via KNX
	Reset (behind label carrier)	Press for less than 2 seconds: no reaction. Press for 2 to 10 seconds: device restart. Retains configuration and last states. Press for more than 10 seconds: factory reset. Deletes configuration and all states.

Table 8: Operating and display elements

#### Note

Device restart and factory reset are only possible if the bus voltage and supply voltage are applied.

#### Note

A firmware update cannot be undone using the factory reset.

# ABB i-bus® KNX

## Product Overview

### 3.4.4 Technical data

#### 3.4.4.1 General technical data

Supply	Bus voltage	21...32 V DC
	Current consumption, bus	< 12 mA
	Power loss, bus	Maximum 250 mW
	Power loss, device	Maximum 3 W
	Supply voltage $U_s$	24 V DC (+20 % / -15 %) or PoE (IEEE 802.3af class 2)
	Current consumption, supply voltage	90 mA typical 120 mA peak current
	KNX connection	0.25 W
	KNX current consumption	< 10 mA
	Connections	KNX
Supply voltage		Via screw terminals 0.2...2.5 mm <sup>2</sup> fine-wire 0.2...4 mm <sup>2</sup> solid
LAN		RJ45 connector for 10/100BaseT IEEE 802.3 networks, autosensing
Degree of protection and protection class	Degree of protection	IP 20 according to EN 60529
	Protection class	II according to EN 61140
Isolation category	Overvoltage category	III according to EN 60664-1
	Pollution degree	II according to EN 60664-1
SELV	KNX safety extra low voltage	SELV 30 V DC
Temperature range	Operation	-5...+45 °C
	Transport	-25...+70 °C
	Storage	-25...+55 °C
Ambient conditions	Maximum air humidity	95 %, no condensation allowed
	Atmospheric pressure	Atmosphere up to 2,000 m
Design	Modular DIN rail component (MDRC)	Modular installation device
	Design	pro <i>M</i>
	Housing/color	Plastic, halogen free, gray
Dimensions	Dimensions	90 x 70 x 64 mm (H x W x D)
	Mounting width in space units	4x 17.5 mm modules
	Mounting depth	68 mm
Mounting	35 mm mounting rail	According to EN 60715
	Mounting position	Any
	Weight	0.192 kg
Approvals	Fire classification	Flammability V-0 as per UL94
	KNX certification	According to EN 50090-1, -2
	Certification	According to EN 60669
	CE marking	In accordance with the EMC and Low Voltage Directives

Table 9: Technical data AC/S 1.2.1

# ABB i-bus<sup>®</sup> KNX

## Product Overview

### 3.4.4.2

#### Device type

Device type	Application Controller	AC/S 1.2.1
	Application	HVAC application/...*
	Maximum number of KNX group objects	2000
	Maximum number of KNX group address assignments	16000
	Maximum number of BACnet objects	500
	Maximum number of BACnet COV subscriptions	2500
	Maximum number of application-specific automation modules (ASM)	500
	• Of which schedulers	15
	• Of which central HVAC	15
	Maximum number of trends	50 values for up to 3 years
	Automation ASM	
	• Maximum number of logic elements	1000
	• Maximum number of sockets	200
	• Maximum number of web user interface I/O	30
	Maximum number of web user interface accesses	5

\* ... = Current version number of the application. Please refer to the software information on our homepage.

Table 10: Device type AC/S 1.2.1

#### **i** Note

ETS and the current version of the device application are required for programming. The latest version of the application and corresponding software information are available for download from [www.abb.com/knx](http://www.abb.com/knx). After import into ETS, the application appears in the *Catalogs* window under *Manufacturers/ABB/Heating Ventilation Air conditioning/Automation Controller*. In addition to the ETS application, you will require ETS DCA "ABB AC/S" for commissioning; this can be obtained free of charge from the KNX online shop. The device does not support the locking function of a KNX device in ETS. If you use a *BCU code* to inhibit access to all the project devices, it has no effect on this device. Data can still be read and programmed.

#### **i** Note

The application "HVAC Application/1.0" and the DCA "ABB AC/S" are supported in ETS 5 only from version 5.6.5. Earlier versions are not supported.

# ABB i-bus<sup>®</sup> KNX

## Product Overview

### 3.4.4.3 Description of inputs and outputs

#### 3.4.4.3.1 Supply voltage input 24 V DC

Only a DC voltage of 24 V is allowed to be connected to the input for the supply voltage. We recommend using an NT/S power supply from our range.



#### **CAUTION**

The supply voltage must be 24 V DC, or the device is supplied via PoE (Power over Ethernet) according to IEEE 802.3af Class 2.

Connecting the device to 230 V may destroy it!

#### 3.4.4.3.2 KNX connection

The supplied bus connection terminal is used to connect to the KNX bus.

#### 3.4.4.3.3 LAN connection

The device connects to the network via an Ethernet RJ45 interface for LAN networks. The network interface can be operated at a transmission speed of 10/100 Mbit/s. Network activity is indicated by the LAN/LINK LED on the front of the device.

The device features an autosensing function and sets the baud rate (10 or 100 Mbit) automatically.

# ABB i-bus<sup>®</sup> KNX Function

## 4 Function

### 4.1 Overview

The *AC/S 1.x.1 Application Controllers* are automation controllers with pre-defined automation modules for comprehensive heating, ventilation and air conditioning automation (HVAC automation). The devices are designed for use from central systems to room automation and contribute to the achievement of energy efficiency goals such as EN 15232.

The devices contain pre-defined application-specific automation modules (ASM) for the most common areas of application, for instance calculation of heat demand, trends or schedulers. You can create your own automation modules using a graphic logic editor. The devices have a web user interface for the display of data and operation; this interface is generated automatically. The *AC/S 1.2.1 Application Controller BACnet* also has an integrated BACnet/IP gateway for the connection of the KNX system to the building control system and other higher level BACnet systems for the bidirectional exchange of data between KNX and BACnet.

Commissioning is undertaken entirely in ETS. Additional external software is not required. The devices have a KNX TP connection and require a supply voltage of 24 V DC or PoE for operation.

### 4.2 Functional overview

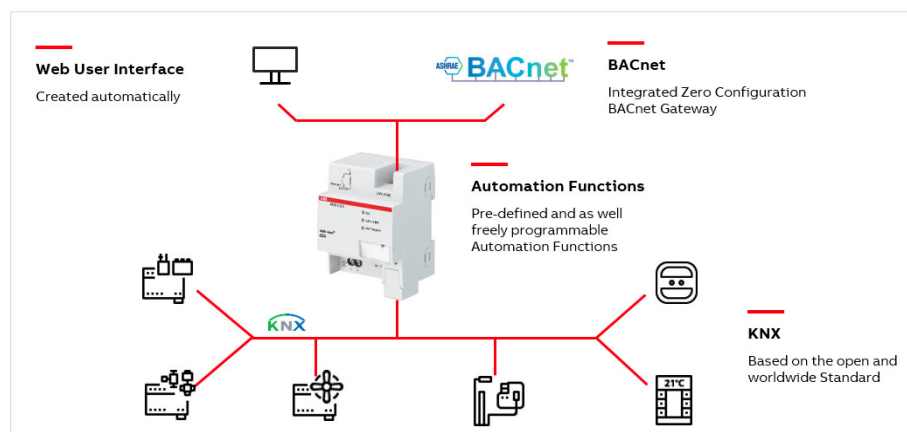

Fig. 7: Functional overview

# ABB i-bus<sup>®</sup> KNX

## Function

### 4.2.1 Automation functions

The devices contain pre-defined application-specific automation modules (ASM) for a comprehensive HVAC automation solution, from central HVAC to room automation, and help you to achieve your energy efficiency goals such as EN 15232 or LEED.

You can create your own automation modules using a graphic logic editor. In this way the straightforward development of logic with simulation on the device or offline is possible.

The device can send the time from NTP (internet) or BACnet on the KNX bus and therefore operate as a clock.

It is possible to record in the device the changes in any 50 values for up to 3 years.

You will find the description of the application-specific automation modules (ASM) from chapter 7.3.

This decentral device offers significantly higher reliability than automation functions in PC-based building control systems.

### 4.2.2 Web user interface

The web user interface is generated automatically based on the application-specific automation modules (ASM) and their parameterization, and can be used for building control as well as for commissioning and maintenance tasks.

The web user interface is optimized for desktop PCs, notebooks and tablets with touch control. The image displayed adjusts automatically to the terminal device.

# ABB i-bus<sup>®</sup> KNX

## Function

### 4.2.3 BACnet

The *AC/S 1.2.1 Application Controller BACnet* has a KNX-BACnet gateway completely integrated into ETS for the integration of the KNX system in a higher level BACnet building control system and other BACnet systems.

- Automatic configuration: pre-defined BACnet objects for application-specific automation modules (ASM).
- Generic BACnet objects with a large selection of selected data point types.
- Bidirectional data exchange between KNX twisted pair (TP) and BACnet/IP.
- BACnet object values can be displayed and changed via the web user interface.
- Integrated BACnet calendar and scheduler: setting the switching times via BACnet, the scheduler is implemented in a fail-safe manner by the AC/S application controller.
- BACnet/IP server with BACnet device profile "Advanced Application Controller (B-AAC)"
- Support for the BACnet properties BBMD/Foreign Device and Notification Class.
- The device is BACnet BTL-listed.

The KNX values are formed in BACnet objects of type binary value and analog value. If the BACnet object is defined in the device configuration as BACnet output, write accesses from BACnet are denied with a BACnet error message.

### 4.2.4 KNX

For reliable communication with the KNX system, the devices have a KNX twisted pair (TP) interface. For quick commissioning, ETS download can also be undertaken via the Ethernet interface.

Commissioning of the devices is undertaken entirely in ETS. Additional external software is not required. The complete parameter configuration is saved in the ETS project and is also included in an ETS project export.

The graphic commissioning interface for the ASMs in ETS is made possible by an ETS Device Configuration App (ETS DCA). For further information on the DCA, see [chapter 6.5, Device Configuration App \(DCA\)](#).

# ABB i-bus<sup>®</sup> KNX

## Function

### **4.3 Functions of the inputs**

This section is not relevant for this device.

### **4.4 Functions of the outputs**

This section is not relevant for this device.

### **4.5 Integration in the i-bus<sup>®</sup> Tool**

The device possesses an interface to the i-bus<sup>®</sup> Tool.

The application controller can be found in the network and the web user interface opened using the i-bus<sup>®</sup> Tool.

You can download the i-bus<sup>®</sup> Tool free of charge from our homepage ([www.abb.com/knx](http://www.abb.com/knx)).

A description of the functions is provided in the i-bus<sup>®</sup> Tool online help.



### **4.6 Special operating states**

#### **4.6.1 Reaction on bus and supply voltage failure, recovery, download and ETS reset**

##### **4.6.1.1 Bus voltage failure**

Bus voltage failure describes the sudden drop in/failure of the bus voltage, e.g. due to a power failure.

If the bus voltage fails but the supply voltage is present, the device continues to operate normally and signals a corresponding error on the web user interface. The device can still be reached using the web user interface and BACnet.

##### **4.6.1.2 Bus voltage recovery**

Bus voltage recovery is the state after bus voltage is restored after failing previously due to a bus voltage failure.

On bus voltage recovery, a corresponding message is output on the web user interface and the group objects are updated, however not initially sent on the bus. New values after bus voltage recovery are sent normally again.

##### **4.6.1.3 Supply voltage failure and recovery**

On the failure of the supply voltage, the device stops its function and, with the aid of the built-in backup power, saves the operating states within 20 to 60 seconds before it shuts down automatically. An error message is output on the web user interface.

After the supply voltage has been restored, also while on backup power, the device restarts and restores the operating states saved.

The internal device clock status remains "invalid" until the device receives the time and date after starting.

# ABB i-bus<sup>®</sup> KNX

## Function

### 4.6.1.4 ETS reset

Generally an ETS reset is defined as a reset of the device via ETS. To trigger an ETS reset, go to the ETS *Commissioning* menu and select *Reset device*. This stops and restarts the application. The group objects are then updated, however they are not initially sent on the bus. New values are sent normally again. For group objects marked with "Read On Init", a Value Read telegram is sent on the bus.

### 4.6.1.5 Download

Downloading describes loading a modified or updated application onto the device with ETS.

#### Note

After a download with a change to the parameters, the reaction is the same as after resetting the device in ETS.  
If the application is downloaded again (full download) after it has been unloaded, the reaction is the same as after an ETS reset.  
After the application is unloaded or after an interrupted download, the device restores the old configuration.

After an ETS download, the internal states for the unchanged ASMs are restored. If an ASM was removed from the previous parameterization, its internal value is discarded. If an ASM was added, its internal value will be set to the default (usually 0).

# ABB i-bus<sup>®</sup> KNX

## Function

### 4.6.2 Unloading ETS application program

The device's group addresses are deleted using the ETS function *Unload Application*. The physical address (KNX) and the IP configuration are retained; the device continues to operate and can be reached via the web user interface and BACnet. If a new application program is then not loaded into the device within 3 seconds, the group addresses are restored. The group objects are updated, however not initially sent on the bus. New values are sent normally again. For group objects marked with "Read On Init", a Value Read telegram is sent on the bus.

### 4.6.3 Unloading ETS physical address & application program

On the use of the ETS function *Unload Application*, the device stops its function and deletes its configuration including the physical address (KNX) and the IP configuration. The device then has the factory settings and sets its IP address using DHCP.

### 4.6.4 Device restart

The device can be restarted by briefly pressing the Reset button (2 to 10 seconds, see [chapter 3.3.3](#), or [chapter 3.4.3](#)), or by running the function on the web user interface (chapter 7.2.3.1). This action corresponds to the reaction on supply voltage failure and recovery.

### 4.6.5 Factory settings

You can undertake a factory reset by pressing the Reset button (more than 10 seconds, see [chapter 3.3.3](#), or [chapter 3.4.3](#)). The device stops its function and deletes its configuration. Only the physical address (KNX) and the IP configuration are retained.

## 4.7 Data point types

General information on data point types

As per the KNX specification for the data point types, there is a distinction between main types and subtypes, e.g.:

<b>DPT main type</b>	<b>DPT subtype</b>	<b>DPT name</b>
1.xxx	1.001	DPT_SWITCH
	1.008	DPT_UPDOWN
	1.100	DPT_HEAT/COOL

Main type: Defines the length.

Subtype: Defines the length and the unit.

If the term data point type (DPT) is used in general, the complete data point type including the subtype is meant.

# ABB i-bus<sup>®</sup> KNX

## Mounting and installation

### 5 Mounting and installation

#### 5.1 Information about mounting

The mounting position can be selected as required.

The electrical connection is made using screw terminals. The connection to the bus is implemented using the supplied bus connection terminal. The terminal assignment is located on the housing.

The device is ready for operation after connecting the bus voltage and the supply voltage.

##### Note

The maximum permissible current on a KNX line must not be exceeded.  
During planning and installation ensure that the KNX line is correctly dimensioned.  
The device has a maximum current consumption of <12 mA.



##### **DANGER – Severe injuries due to touch voltage**

Feedback from differing phase conductors can produce touch voltages and lead to severe injuries.  
Operate the device only in a closed housing (distribution board).  
Disconnect all phases before working on the electrical connection.

# ABB i-bus<sup>®</sup> KNX

## Mounting and installation

### 5.2 Mounting on DIN rail

The device is fitted and removed without auxiliary tools.

Make sure the device is accessible for operation, testing, visual inspection, maintenance and repair.

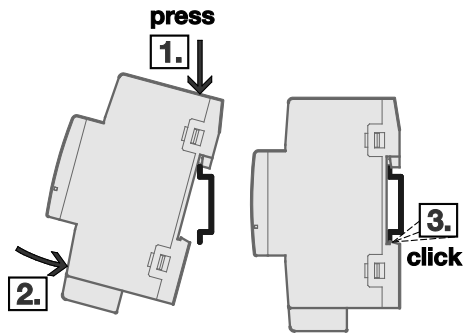

Fig. 8: Mounting

1. Place the DIN rail holder on the upper edge of the DIN rail and push down.
2. Push the lower part of the device toward the DIN rail until the DIN rail holder engages.
  - ⇒ The device is now mounted on the DIN rail.
  - ▶ Relieve the pressure on the top of the housing.

### 5.3 Supplied state

The device is supplied with the physical KNX address 15.15.255, the IP configuration is set to "Obtain an IP address automatically". For more information on the IP address, see [chapter 6.3.1. Network settings](#).

The device is ready for operation in the state as supplied. You can access the web user interface using the user "admin" and the initial password "Admin123".

The BACnet server is deactivated in the state as supplied.

2CDC072013F0015

# ABB i-bus<sup>®</sup> KNX Commissioning

## **6 Commissioning**

### **6.1 Prerequisites for commissioning**

To commission the device, a PC with ETS is required along with a connection to the ABB i-bus<sup>®</sup>, e.g. via a KNX interface.

The device is ready for operation after connecting the bus voltage and the supply voltage.

## 6.2 Commissioning overview

The individual commissioning steps should be undertaken in the following recommended sequence:

Commissioning steps	Remark
1. Installation of the ETS application	See <a href="#">chapter 6.4, Software / application</a>
2. Installation of DCA	See <a href="#">chapter 6.4, Software / application</a>
3. Configuration of the device addresses	The configuration of the physical KNX address and the IP configuration can also be undertaken without DCA installed.
<ul style="list-style-type: none"> <li>Physical KNX address</li> </ul>	See <a href="#">chapter 6.3, Assignment of the physical address</a>
<ul style="list-style-type: none"> <li>IP configuration</li> </ul>	See <a href="#">chapter 6.3.1, Network settings</a>
<ul style="list-style-type: none"> <li>BACnet device address</li> </ul>	See <a href="#">chapter 7.2.2.3, BACnet parameter page</a>
4. Device firmware update check	Check whether an update is available for the device software. In general an update will provide new functions and rectify any bugs. See <a href="#">chapter 10.3, Software update</a>
5. Minimum parameterization of the device	
<ul style="list-style-type: none"> <li>Set device clock</li> </ul>	See <a href="#">chapter 7.2.2.5, Clock parameter page</a>
<ul style="list-style-type: none"> <li>Set users and passwords</li> </ul>	See <a href="#">chapter 7.2.2.4, WebUI - Users parameter page</a>
<ul style="list-style-type: none"> <li>Set encrypted access to the web user interface</li> </ul>	See <a href="#">chapter 7.2.3.7, SSL certificate parameter page</a>
6. Parameterization of the device	For a description of the commissioning interface in DCA, see <a href="#">chapter 6.5, Device Configuration App (DCA)</a>  For a description of the application-specific automation modules (ASM) as well as the general device settings, see <a href="#">chapter 7</a>  For general notes and remarks, see <a href="#">chapter 12, Planning and application</a>

Table 11: Commissioning overview

The parameters are downloaded to the device using the ETS function *Download*. See [chapter 6.5.11, Download reaction](#).

The device is then in operation and undertakes the functions parameterized. For information on the operation of the web user interface, see [chapter 9.2, Web user interface](#).

If you have any problems, see [chapter 10.4, Support](#).



## 6.3 Assignment of the physical address

The physical address, group address and parameters are assigned and programmed in ETS.

The device features a *Programming* button for physical address assignment. The red *Programming* LED lights up after the button has been pressed. It goes off once ETS has assigned the physical address or the *Programming* button is pressed again.

The device's programming mode can also be used via the web user interface. See [chapter 7.2.3.3, KNX programming mode parameter page](#).

### Note

The first time the physical address is programmed after the addition of the device to an ETS project, the connection to the device must be made using the KNX twisted pair (TP). Subsequent programming and downloads can be undertaken using the ETS function "Direct IP connection" via the Ethernet interface. See [chapter 6.5.11, Download reaction](#).

### 6.3.1 Network settings

DHCP ("Obtain an IP address automatically") is enabled on the device as standard. So the device obtains its IP address from a DHCP server which is often integrated into a network switch or router. If there is no DHCP server available, the device starts an AutoIP procedure and automatically assigns itself an IP configuration:

IP address from the auto IP range: 169.254.1.0 to 196.254.254.255

Subnet mask: 255.255.0.0

Default gateway: 0.0.0.0

The IP configuration (by DHCP or AutoIP) received on startup is retained until the next restart (switched off/on or reprogramming) or until a DHCP server is available again.

# ABB i-bus® KNX Commissioning

## **No DHCP server available during startup:**

If no DHCP server is available within one minute during startup, the device assigns itself an AutoIP address. The device then cyclically (3 telegrams at intervals of 3 seconds, followed by a pause of 20 seconds) searches for a DHCP server. As soon as a server is available again, the address assigned by the DHCP server is used.

## **DHCP server fails (device has already received IP address from DHCP):**

Requests to extend the utilization rights for this IP address remain unanswered until the end of the lease time (IP address validity time; this is defined by the DHCP server during assignment of the IP address). The IP address continues to be used.

At the end of the lease time or after a download, the device searches for an AutoIP address.

The settings for the IP configuration are made in ETS in Devices → Properties → IP. Here you can also assign a fixed IP address to the device along with the related subnet mask and the default gateway. The DNS address must also be specified. This address is required so that the device can resolve domains and therefore, for example, contact the NTP server for the time synchronization



### **ATTENTION –**

The IP configuration must match the network topology. Otherwise it will not be possible to contact the device and it will be necessary to restore the factory settings. See [chapter 4.6.5, Factory settings](#).

The IP configuration is loaded into the device on programming the physical address. See [chapter 6.3, Assignment of the physical address](#).

You can use the following methods to determine the IP configuration actually used by the device:

- Via the i-bus® Tool. See [chapter 4.5, Integration into the i-bus® Tool](#)
- Via the ETS diagnostic function "Device Info". For this purpose the physical address is required. The physical address can be determined using the ETS diagnostic function "Programming Mode".
- Status messages from the DHCP server. For further information, see manual for your DHCP server.

You will find the network ports used by the device in [chapter 2.8, Open IP network ports](#).

# ABB i-bus<sup>®</sup> KNX Commissioning

## 6.4 Software/application

For the AC/S 1.x.1 application controller there is the application "HVAC Application/1.0".

In addition to the ETS application, you will require the ETS Device Configuration App (DCA) "ABB AC/S" for commissioning; this can be obtained free of charge from the KNX online shop.

For more information on the installation of DCA, see ETS help.

### Note

The application "HVAC Application/1.0" and the DCA "ABB AC/S" are supported in ETS 5 only from version 5.6.5. Earlier versions are not supported.

ETS is required to parametrize the device.

For information on how to use the i-bus<sup>®</sup> Tool, see 4.5 [Integration in the i-bus<sup>®</sup> Tool](#)

### Note

A description of the functions is provided in the i-bus<sup>®</sup> Tool online help.

# ABB i-bus<sup>®</sup> KNX Commissioning

## 6.5 Device Configuration App (DCA)

### 6.5.1 Overview

Once DCA has been successfully installed, an additional "DCA" tab appears in the device view in ETS.

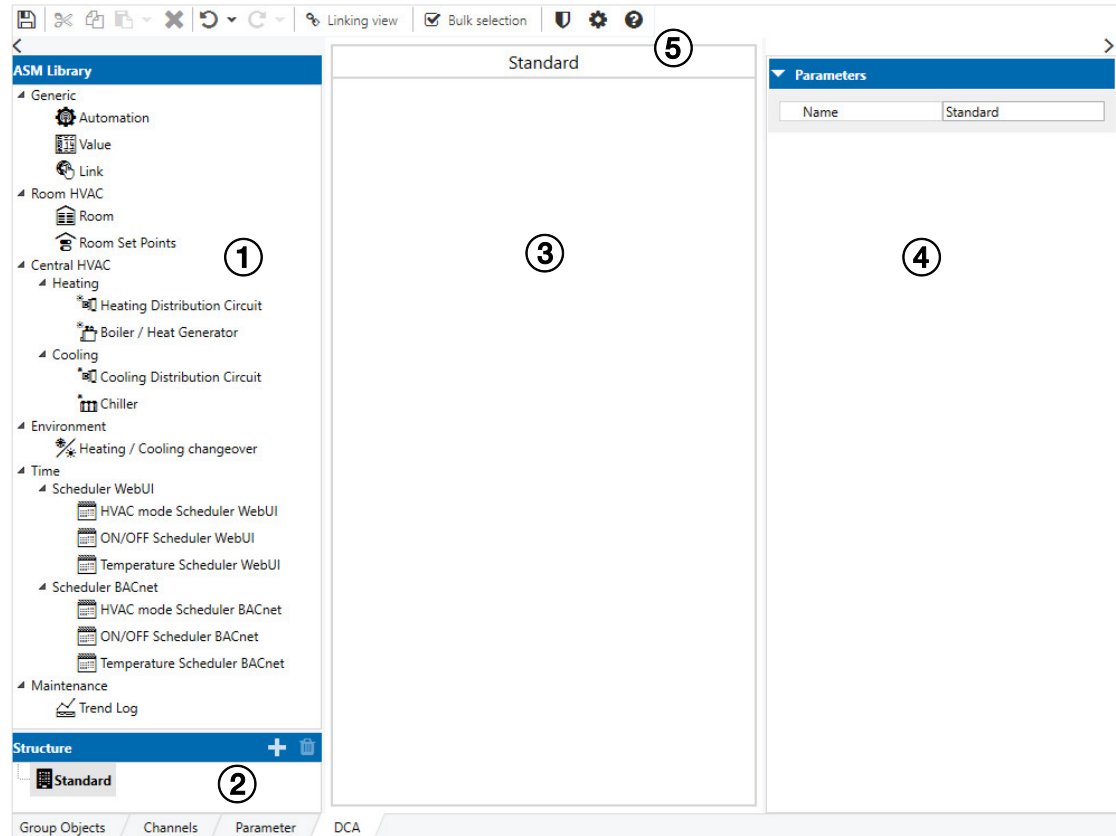

Fig. 9: Overview of DCA

#### Legend

- |   |             |   |                    |
|---|-------------|---|--------------------|
| 1 | ASM library | 4 | ASM properties bar |
| 2 | Structure   | 5 | Menu bar           |
| 3 | Workspace   |   |                    |

# ABB i-bus<sup>®</sup> KNX Commissioning

## 6.5.2 ASM library

All application-specific automation modules (ASM) available for the device are displayed in this section. From there the ASM can be dragged to the workspace (drag & drop) for parameterization. As an alternative, a double-click adds the selected ASM to the Standard workspace.

The help texts and the standard parameters for the ASM selected in the ASM library are displayed in the ASM property bar for information.

Click  to minimize and maximize the ASM library.

## 6.5.3 Structure

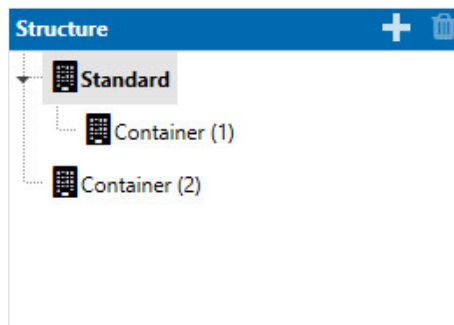

To structure the project (e.g. parts of the building, parts of the system, ...) you can add containers by clicking the  symbol. The containers are displayed in the workspace; the ASMs are added to the containers using drag & drop.

Containers can be nested one inside the other. The web user interface with the navigation menu is generated automatically from the container structure created.

If you delete a container using the  symbol, you will also delete the ASMs it contains.

The Standard container can only be renamed, but not deleted.

# ABB i-bus® KNX Commissioning

## 6.5.4 Workspace

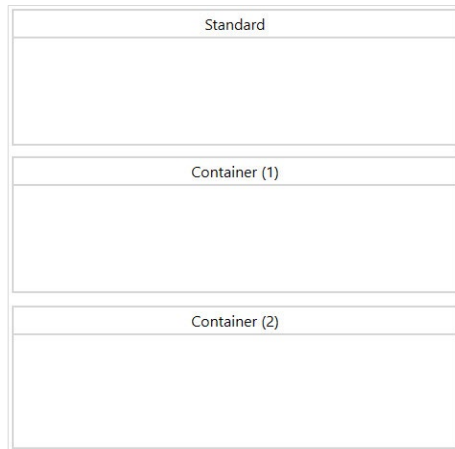

The application-specific automation modules (ASM) to be installed on the device are added to the workspace from the ASM library and can then be parameterized. The next time the device is programmed (download) these modules are transferred to the device.

The structure defined in the workspace from the ASM sequence and containers is also displayed on the web user interface. The sequence of the ASMs can be changed by dragging.

The information and values displayed in the ASM tiles are only examples that provide an impression of how they are displayed on the web user interface. This information does not contain any values from the device and also does not represent the ASM parameterization.

An exclamation mark in the top right corner of the ASM tile refers to an ASM input socket that still needs to be linked.

## 6.5.5 ASM properties bar

The ASM properties bar displays the parameters and the information from selected ASM or container. The ASM is parameterized in this section.

For further information, see from chapter 7.3.

Click  to minimize and maximize the ASM properties bar library.

# ABB i-bus<sup>®</sup> KNX Commissioning

## 6.5.6

### Menu bar

Various functions and commands for editing the project are available on the menu bar. You will find further information in the following chapters.

#### Save



ETS automatically saves the changes in the ETS project at regular intervals and on leaving DCA. If changes to the project have not yet been saved, the following message is displayed:

**Projektdatein wurden geändert. Bitte speichern Sie das Projekt bevor Sie das Gerät programmieren (download).**

If this message is displayed and you want to program the device (download), please first click "Save", otherwise the latest configuration will not be loaded into the device.

#### Edit



Buttons for cutting, copying, pasting and deleting a selected element.

#### Undo and redo



Buttons for using the undo and redo function within DCA.

#### Linking view



Button for opening and closing the Linking view with the ASM selected.

# ABB i-bus® KNX Commissioning

## Bulk selection



Opens the *Bulk selection* function using which you can select more than one ASM by selecting the checkbox at the top of the ASM tiles. Alternatively, you can select more than one ASM using the mouse with the Control key on the keyboard pressed.

## Settings



Buttons for opening the project verification window, the DCA device settings window and the device information (DCA version number and legal disclaimer).

## The following buttons are only available in the Linking view:

### Slider



Increase / reduce size of Linking view.

### Grid



Show/hide background grid in the Linking view.



# ABB i-bus<sup>®</sup> KNX Commissioning

## 6.5.7 Linking view

In the Linking view you can link together the ASMs for the device-internal exchange of values.

Display the ASMs in the linking view by first selecting them in the workspace and then clicking the button on the menu bar for opening the Linking view. You can select several ASMs either by clicking them with the mouse with the Control key on the keyboard pressed, alternatively you can use the *Bulk selection* function on the menu bar.

All ASMs selected are displayed on a worksheet in the Linking view. The ASMs are arranged automatically and you can change the arrangement as required by dragging. DCA saves the last 30 arrangements such that the recent arrangements can be restored if the same ASMs are selected on opening the Linking view again. ASMs outside the field of view can be reached by scrolling or changing the zoom setting.

### ASM input sockets

The ASM input sockets are displayed in the ASM tiles on the left. The module receives values from other ASMs via these objects. Every input on an ASM must be linked. It is not allowed to leave an input unlinked because otherwise the module will be lacking a value for its automation function. ASMs with unlinked input sockets are marked in the workspace with an exclamation mark in the tile.

ASM input sockets can only be linked to one ASM output socket. Exceptions are ASM multiple sockets.



Depending on the application, ASM multiple sockets have one of the following aggregate functions integrated so that several signals can be linked.

- Selection of maximum
- Selection of minimum
- Average calculation
- OR operator
- AND operator

# ABB i-bus® KNX

## Commissioning

### **ASM output sockets**

The ASM output sockets are displayed in the ASM tiles on the right. The module sends values to other ASMs via these objects. The outputs can also remain unlinked.

An ASM output socket can be linked to as many ASM input sockets as necessary.

The sockets available depend on the parameterization of the ASM.

Make the link by clicking an output socket with the mouse and dragging to the required input socket with the left mouse button pressed. A green check mark indicates a possible link with the required input socket. Make the link by releasing the mouse button.

### **Note**

If sockets are hidden due to modified ASM parameters, their link will be deleted without warning. If sockets are shown again, the original link is not restored. In this situation, use the *Undo* function.

# ABB i-bus® KNX Commissioning

The socket data point types used correspond to the data point types (DPT) in the KNX standard and comprise the main type and the subtype. For further information, see [chapter 4.7, Data point types](#). Move the mouse over the sockets to display the data point type. The main type is also apparent from the color of the sockets.

It is only possible to link sockets of the same main type or also subtype.

- DPT 1.xxx and DPT 1.xxx = OK
- DPT 1.xxx and DPT 1.001 = OK
- DPT 1.xxx and DPT 9.xxx = Not possible
- DPT 1.001 and DPT 1.002 = Not possible

ASM input and output sockets have a + symbol if they are linked to ASMs not currently shown in the Linking view. Click the + symbol to show these ASMs in the Linking view.

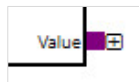

You can hide ASMs from the Linking view using the – symbol in the bar at the top of the ASM.

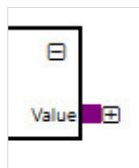

# ABB i-bus<sup>®</sup> KNX

## Commissioning

### 6.5.8 Copying, cutting and pasting

The device supports different types of *copying*, *cutting* and *pasting*. These functions can be used to copy similar configurations or example projects.

#### Copying, cutting and pasting a device

You can copy the entire device including its parameters (ASMs, settings etc.) and the group addresses linked using the ETS functions *Copy*, *Cut* and *Paste*. Use the advanced *Paste* function to adjust the group addresses during the paste.

This works both within an ETS project and between two open ETS projects.

#### **Note**

After the paste, the IP address and the BACnet address must be changed because these are only allowed to be used once.

# ABB i-bus<sup>®</sup> KNX Commissioning

## Copying, cutting and pasting ASMs within a device

ASMs can be copied, cut and pasted within the workspace. You can access the functions using the button on the DCA menu bar, on the context menu after clicking the ASM using the right mouse button, or using the keyboard commands (Ctrl + C, Ctrl + X and Ctrl + V).

On copying ASMs, the ASM settings are also copied. ASM input/output socket links between the ASMs are not copied. If these links are also to be copied, use the *Paste special* function on the context menu after clicking using the right mouse button or the button on the menu bar. The following copy functions are then possible:

- *Do not copy*: Links between the ASMs are not copied. This is the same as the normal copy function
- *Only copy links between copied ASMs*: Only the links between the ASMs copied (selected) are copied. Links to ASM input/output objects on other ASMs not selected are not copied.
- *Copy all links*: All links are copied. This includes on the one hand the links between the ASMs copied (selected) as well as the links to the ASMs not copied (selected).  
In this situation the links to ASM multiple input sockets and to ASM output objects are copied. Links to normal ASM input sockets cannot be copied because these can only ever be linked to one ASM output socket.  
This function is useful for duplicating the configurations that are the same and at the same time copying the links to central values, e.g. the outside temperature.

Group addresses that are linked to the ASM's group objects cannot be copied due to a limitation in ETS.

## Copying, cutting and pasting ASMs between two devices

ASMs can also be copied between two devices in the same ETS project, or between two ETS projects open at the same time.

This process functions in exactly the same way as described in the section "Copying, cutting and pasting ASMs within a device", however with the limitation that the *Copy all links* is not available.



### Note

Copying, cutting and pasting only functions between devices of the same type.

# ABB i-bus® KNX Commissioning

## 6.5.9 Undoing and redoing



You can undo individual changes made in ETS using the *Undo* button on the menu bar in DCA. Click the  button to display the history for the recent changes;  where you can select specific changes.

Use the *Redo* button on the menu bar in DCA to redo changes undone in ETS using the *Undo* button.

These two functions include every single change made in the ETS in chronological order. Here the functions take into account every change in DCA on the application controller, and every general change in the ETS project (group address, building structure, other KNX device parameters).

The *Undo and Redo* function in ETS can also undo and redo every change outside DCA individually. However, it can only ever undo and redo changes within DCA back to when the DCA configuration was saved. As such, it is not possible to select every individual step in DCA using the ETS *Undo and Redo* function. We therefore recommend using the DCA *Undo and Redo* function.

# ABB i-bus<sup>®</sup> KNX Commissioning

## 6.5.10 Project verification



The *Project Verification* function states what is utilized on the device. For example the number of ASMs used, KNX group objects or BACnet objects.

If a limit is reached, an error message is displayed and the action is not undertaken. You can check the utilization of the device at any time using this function

## 6.5.11 Download reaction

Download the device parameters using the ETS function *Download*.

### Note

ETS automatically saves the changes in the ETS project at regular intervals and on leaving DCA. If changes to the project have not yet been saved, the following message is displayed:

**Project data has changed. Please save the project before device programming (download)**

If this message is displayed and you want to program the device (download), please first click "Save", otherwise the latest configuration will not be loaded into the device.

A fast download to the device is possible using the device's Ethernet interface, if the ETS function *Direct IP connection* is activated in the ETS settings. Otherwise download is via the device's KNX TP interface. Due to the long time the download will take, this method is not recommended.

## 6.5.12 Copying, exchanging and converting

The "ABB Update Copy Convert" ETS application from the KNX online shop cannot be used to copy or exchange parameter settings or to convert the application version. Instead see [chapter 6.5.8, Copying, cutting and pasting](#).





# ABB i-bus<sup>®</sup> KNX

## Parameters

### 7 Parameters

#### 7.1 General

The ETS Engineering Tool Software is always used to parameterize the device.

The KNX-related device settings are in the device's parameter window and can be changed also without DCA installed. See [chapter 7.2.1, ETS parameters](#).

All other device and ASM settings can be set within DCA. See [chapter 7.2.2, DCA device settings](#) for device settings and the descriptions of the individual ASMs from chapter 7.3 for ASM settings.

General settings for the web user interface are made on the web user interface and are described in [chapter 7.2.3, Web user interface device settings](#).

You will find the ASM-related settings in the web user interface in [chapter 9.2, Web user interface](#).

The following chapters describe the parameters for the ASMs based on the parameter windows. Parameter windows are structured dynamically so that further parameters may be enabled depending on the parameterization and the function.

#### Note

The AC/S 1.2.1 is used as an example for the descriptions and screenshots. For this reason the BACnet-related information is not relevant for the AC/S 1.1.1.

The default values of the parameters are underlined, e.g.:

Options: No

# ABB i-bus<sup>®</sup> KNX Parameters

## 7.2 Global device settings

### 7.2.1 ETS parameters

#### Telegrams per second rate

Options:      No limit  
                  1  
                  2  
                  3  
                  5  
                  10  
                  20

This parameter defines how many KNX telegrams the device is allowed to send on the KNX bus per second. If this value is exceeded, the device saves the telegrams and sends them the next time possible. If the value of a group object not yet sent changes in the meantime, only the latest value is sent.

This parameter is also displayed in the DCA device settings and can be changed there.

# ABB i-bus<sup>®</sup> KNX Parameters

## 7.2.2 DCA device settings



You can open the DCA device settings using the *Settings* button on the DCA menu bar. See [chapter 6.5.6, Menu bar](#).

### 7.2.2.1 IP network parameter page

Setting for the DNS server address. This address is required so that the device can resolve domains and therefore, for example, contact the NTP server for the time synchronization.

You will find the general IP settings for the device in [chapter 6.3.1, Network Settings](#).

### 7.2.2.2 KNX parameter page

#### Rate of telegrams

Options:            Do not limit  
                         1  
                         2  
                         3  
                         5  
                         10  
                         20

This parameter defines how many KNX telegrams the device is allowed to send on the KNX bus per second. If this value is exceeded, the device saves the telegrams and sends them the next time possible. If the value of a group object not yet sent changes in the meantime, only the latest value is sent.

This parameter is also displayed in the device's ETS KNX parameter window and can be changed there.

# ABB i-bus<sup>®</sup> KNX Parameters

## 7.2.2.3 BACnet parameter page

This parameter page is only available on the *AC/S 1.2.1 Application Controller BACnet*.

### BACnet server enable

Options:           No (checkbox cleared)  
                      Yes (checkbox selected)

Use this parameter to enable/disable the device's BACnet function globally. If the BACnet server is disabled, it is not possible to communicate with the device via BACnet.

### BACnet device object instance number

Options:           0...194302

Definition of the BACnet device address.

#### Note

The BACnet device address must be unique in the BACnet network and is not allowed to be assigned twice.

### BACnet device object name

Definition of the BACnet name of the device. The device uses this name in the BACnet network.

### BACnet protocol port

Options:           47808...47823, 49152...65535

Definition of the IP port the BACnet server uses. This port must be set to suit the BACnet network.

# ABB i-bus<sup>®</sup> KNX Parameters

## **BACnet/IP Foreign Device**

Options:        No (checkbox cleared)  
                  Yes (checkbox selected)

Use this parameter to activate the function with which the device registers as BACnet/IP foreign device on a remote BACnet Broadcast Management Device (BBMD). This is necessary if the device is in a different IP subnet to the rest of the BACnet devices.

Selection of Yes option:

Dependent parameter(s):

## **Foreign Device Address**

Information on the IP address and the port used by the BACnet Broadcast Management Device (BBMD). This setting must match the setting on the BBMD.

The information must always consist of the IP address followed by the port number. IP address and port number must be separated by a colon, e.g. 192.168.1.10:47808

## **Foreign Device Registration Time**

Options:        1...60...65535 s

Information on the interval in seconds at which the device renews its registration on the BACnet Broadcast Management Device (BBMD). This setting must match the setting on the BBMD.

# ABB i-bus<sup>®</sup> KNX Parameters

## 7.2.2.4 WebUI – Users parameter page

Five user profiles with a corresponding rights structure are predefined for the device's web user interface. It is not possible to add any more profiles.

On this parameter page you can set or reset the passwords for four of the web user interface users; it is not possible to assign a password to the "without login" profile. The passwords are active on the device after the ETS download.

Every user can change their password in web user interface. In the state as supplied, you can access the web user interface using the user "admin" and the initial password "Admin123".

For further information, see [chapter 7.3.3, Web user interface](#).

User profile	Rights
admin	"Administrator" This user has all rights <ul style="list-style-type: none"><li>• Change everything in the ASM detailed view on the web user interface</li><li>• Change web user interface settings</li><li>• Undertake firmware updates</li><li>• Delete messages</li></ul>
expert	"Expert" This user has the following rights: <ul style="list-style-type: none"><li>• Change everything in the ASM detailed view on the web user interface</li></ul>
user	"User" This user has the following rights: <ul style="list-style-type: none"><li>• Change the normal settings in the ASM detailed view on the web user interface. Expert settings are read-only.</li></ul>
viewer	"Viewer" This user has the following rights: <ul style="list-style-type: none"><li>• Can read all settings in the ASM detailed view on the web user interface, but not change them.</li></ul>
without login	"Without login" This user profile can be used to make ASMs visible even without logging into the web user interface. In this situation, the following rights are possible: <ul style="list-style-type: none"><li>• Can read all settings in the ASM detailed view on the web user interface, but not change them.</li></ul>

# ABB i-bus<sup>®</sup> KNX Parameters

## 7.2.2.5

### Clock parameter page

#### Clock synchronization source

Options:        NTP  
                  KNX  
                  BACnet

- *NTP*: The device clock is set using a time server in the IP network or the Internet. The device must be able to communicate with the time server and access must not be blocked (e.g. by a firewall).
- *KNX*: The device clock is set via the KNX bus. The KNX time server must be connected to the related device group objects.
- *BACnet*: The device clock is set via the BACnet bus. The device clock must be set via the BACnet time synchronization function by the BACnet time server.

Selection of *NTP* option:

Dependent parameter(s):

#### **NTP server**

Information on the IP address or the NTP time server's domain.

#### **Time zone**

Selection of the time zone in which the device is located.

# ABB i-bus<sup>®</sup> KNX Parameters

## 7.2.3 Web user interface device settings

You can open the device settings using the *Settings* button on the menu bar on the web user interface. See [chapter 9.2.1, Menu bar](#). The button only appears after you have logged in.

If not otherwise stated, all parameters on the web user interface apply to all users.

### 7.2.3.1 System tools parameter page

SYSTEM TOOLS	
Restart device	<input type="button" value="Restart"/>
Restart application	<input type="button" value="Restart"/>

#### Restart device

The device is restarted. See [chapter 4.6.4, Device restart](#).

#### Restart application

The web user interface is restarted. All user connections are closed.



# ABB i-bus<sup>®</sup> KNX Parameters

## 7.2.3.2 Firmware update parameter page

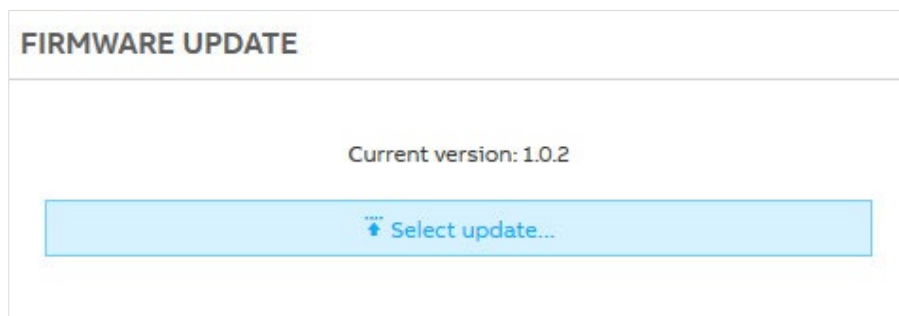

On this page you can update the software in the device. The device configuration is deleted during the update. Only the physical KNX address and the IP configuration are retained. All values and states saved are lost. The configuration must be programmed again by means of an ETS download.

## 7.2.3.3 KNX Programming mode parameter page



On this page you can place the device in the KNX programming mode or deactivate again the KNX programming mode. See [chapter 6.3, Assignment of the physical address](#).

The current state is displayed and is synchronized with the device Programming LED.

# ABB i-bus<sup>®</sup> KNX Parameters

## 7.2.3.4 Monitor mode parameter page

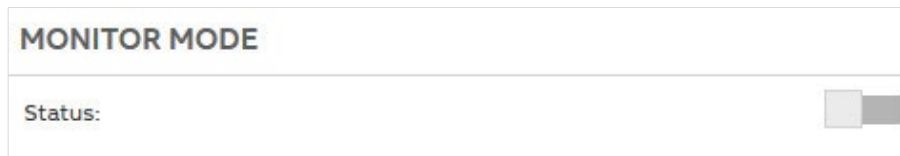

MONITOR MODE

Status:

On this page you can activate and deactivate monitor access to the ASM automation in the device using the Status slider. You can see the current states of the logic in the device in real time using the Monitor function.

For security reasons this access should only be activated if required and then deactivated again.

## 7.2.3.5 SSH access parameter page

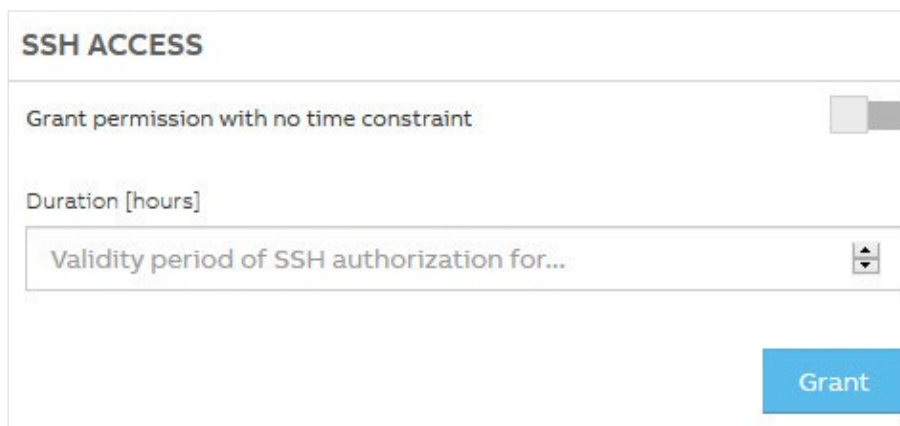

SSH ACCESS

Grant permission with no time constraint

Duration [hours]

Validity period of SSH authorization for...

Grant

Using this function you can grant the device manufacturer, on request, diagnostic access to the device if there is a fault.

You can limit the access to a specific number of hours and withdraw it at any time.

See [chapter 10.4, Support](#).



### ATTENTION –

Only activate this function on request from the device manufacturer.

# ABB i-bus<sup>®</sup> KNX Parameters

## 7.2.3.6

### Log settings parameter page

#### LOG SETTINGS

Log level	info ▾
Export log files	Export

The device maintains an internal log on its internal software events. This log is useful during diagnostics on a possible device fault. See [chapter 10.4, Support](#).

You can export this log as a file using the *Export* button.



#### ATTENTION –

Only export the log on request from the device manufacturer and do not provide it to others because this file could contain private data.

Using the *Log level* menu you can set the level of detail for the log.



#### ATTENTION –

Only change this parameter on request from the device manufacturer because it affects the device performance.

# ABB i-bus<sup>®</sup> KNX

## Parameters

### 7.2.3.7 **SSL certificate parameter page**

The data connection between the terminal device (computer, tablet,...) and the device on opening the web user interface is, by default, not protected against access or changes by others.

Activate this function to establish a secure data connection. For this purpose the https protocol is used instead of the http protocol. This protocol will encrypt the data connection and it will no longer be possible for others to read and change the data. It is prerequisite for the encryption that both communication partners (terminal device and application controller) authenticate themselves using certificates. For this purpose both communication partners must have a certificate that the other accepts as valid.

You can create a new certificate on the device and then install it as trusted on all terminal devices to be used to access the device's web user interface. If you do not install the certificate on the terminal devices (browsers), then you will receive a warning that the data connection is not secure due to the lack of authentication and it is not trusted.

# ABB i-bus<sup>®</sup> KNX Parameters

## SSL CERTIFICATE

Upload certificate    **Create certificate**

**i** Right after a successful certificate installation, all users of the device are redirected to the HTTPS version of the WebUI. Users who do not have the updated certificate installed will be presented with a warning about untrusted/unknown content. It is recommended to install the certificate on all systems and browsers.

Enable for whole subnet

Additional host name / IP address

**Add**

**Create**

In the "Additional host name / IP address" field you can specify additional addresses that can be used to communicate with the device and for which the certificate is to be used. By default the device IP address set in ETS is always added to the certificate.

# ABB i-bus<sup>®</sup> KNX Parameters

Alternatively, you can also create a certificate externally or buy a certificate and install it in the device in the .pem file format.

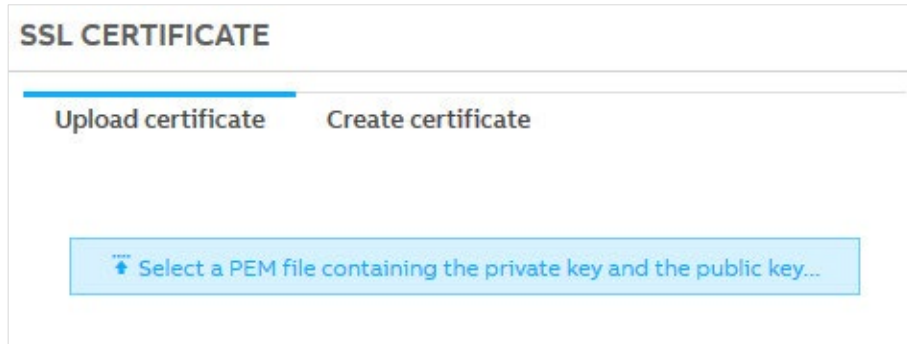

As soon as you have activated the secure data connection, the web user interface is refreshed with the secure connection. Unencrypted access to the device is then no longer possible. The user "admin" can delete the SSL certificate again at any time. The button is shown as soon as an SSL certificate has been installed on the device.

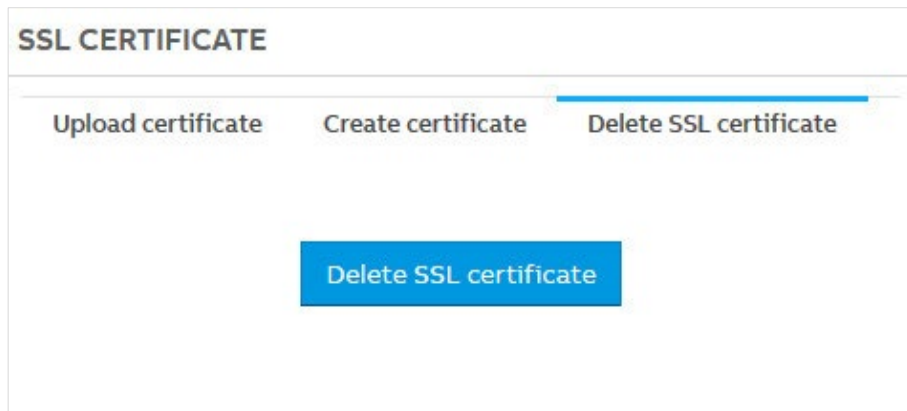

# ABB i-bus<sup>®</sup> KNX Parameters

## 7.2.3.8 Connection settings parameter page

CONNECTION SETTINGS			
User	Connection time		Disable session timeout
admin	<input type="text" value="0"/> Min.		<input checked="" type="checkbox"/>
expert	<input type="text" value="20"/> Min.		<input type="checkbox"/>
user	<input type="text" value="20"/> Min.		<input type="checkbox"/>
viewer	<input type="text" value="20"/> Min.		<input type="checkbox"/>

You can set on this page, for each user of the web user interface, whether the user is automatically logged out from the web user interface after inactivity for security reasons. If this function is activated, set here the number of minutes of inactivity after which automatic user logout is to occur.

# ABB i-bus<sup>®</sup> KNX Parameters

## 7.3 Global ASM settings

The global ASM settings are on the ASM properties bar in DCA and are identical for all ASMs. For this reason the settings are described once below as an example.

### 7.3.1 General

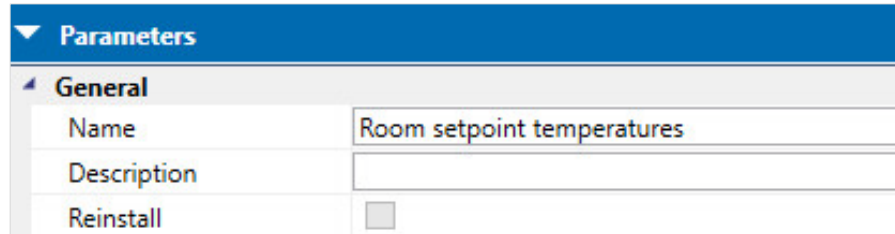

Parameters	
General	
Name	Room setpoint temperatures
Description	
Reinstall	<input type="checkbox"/>

#### **Name**

Name of the ASM; the name can be selected as required. It is used for the display of the ASM on the web user interface as well as to name the group objects and the BACnet objects.

#### **Description**

Enter in this text field any notes and comments on the ASM. This description is only displayed at this point and nowhere else.

#### **Reinstall**

Options:            No (checkbox cleared)  
                      Yes (checkbox selected)

After the successful download of an ASM to the device, the parameters for the ASM are locked against changes in ETS. If parameters need to be changed, the ASM must be reinstalled; undertake this action by selecting the checkbox. In this way the parameters can be changed again and the ASM is reinstalled on the device with the next download. See [chapter 6.5.11, Download reaction](#).



# ABB i-bus<sup>®</sup> KNX Parameters

## 7.3.2 BACnet

This parameter page is only available on the AC/S 1.2.1 Application Controller BACnet.

BACnet	
<b>Endpoints Enabled</b>	
Enable...	<input type="checkbox"/>
<b>Cooling Protection</b>	
Enabled	<input type="checkbox"/>
Name	Room Set Points: Cooling Protection <input type="checkbox"/> custom name
Id	1701 <input type="button" value="↑"/>

### Endpoints enabled

#### Enable all

Options:      No (checkbox cleared)  
                 Yes (checkbox selected)

Use this option to enable/disable all BACnet objects in the ASM.

# ABB i-bus<sup>®</sup> KNX

## Parameters

The following parameters are available for each BACnet object:

### **Enabled**

Options:            No (checkbox cleared)  
                      Yes (checkbox selected)

Use this option to enable/disable the related BACnet object in the ASM.

### **Name**

Options:            No (checkbox cleared)  
                      Yes (checkbox selected)

By default the name of the BACnet object is generated automatically from the ASM name and the object name. If you select the *Custom name* checkbox you can specify any name you require.

The BACnet object name must be unique within the device. If the name you enter is already used by another BACnet object in the device, DCA outputs an error message and does not allow the name to be saved. In this situation the last name is restored.

### **ID**

The number of the BACnet object is generated automatically by default.

You can change the BACnet object number. This number must be unique within the device. If the number you select is already used by another BACnet object in the device, DCA outputs an error message and does not allow the number to be saved. In this situation the last number is restored.

# ABB i-bus<sup>®</sup> KNX Parameters

## 7.3.3 WebUI

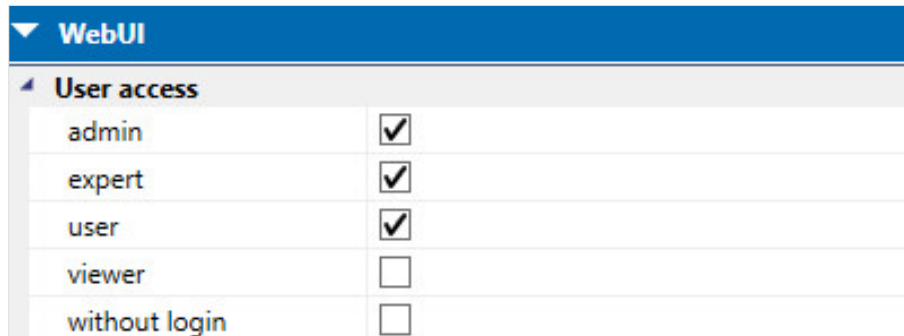

WebUI	
User access	
admin	<input checked="" type="checkbox"/>
expert	<input checked="" type="checkbox"/>
user	<input checked="" type="checkbox"/>
viewer	<input type="checkbox"/>
without login	<input type="checkbox"/>

Select the checkbox to specify for each web user interface user profile whether the ASM is displayed on the web user interface. This setting does not have any effect on the rights for the related user profile in the detailed view for the ASM on the web user interface.

If the user "without login" is activated, the ASM is displayed without even logging into the web user interface.

For further information on user profiles, see [chapter 7.2.2.4, WebUI - Users parameter page](#).

## 7.3.4 Info

The information dialog box contains general information on the ASM.

### ID

The unique ASM ID on the device. This will be needed by the device manufacturer for diagnostics purposes if there is a fault.

### Type

Information on the ASM type as it is also identified in the ASM library.

### Version

Version number for the ASM.

## 7.3.5 Help

The general description text for the ASM is displayed in the Help dialog box.

# ABB i-bus® KNX Parameters

## 7.4 Automation ASM

### 7.4.1 General

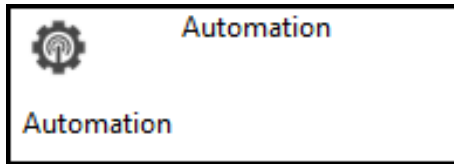

Using this application-specific automation module (ASM), you can program your own ASMs with the aid of a graphic logic editor. This is a solution for applications that are not covered by the predefined modules supplied with the application controller.

You can define the input and output sockets on the custom modules as required. You can also define read-only and other fields for the web user interface.

It is not possible to define group objects and BACnet objects directly from within custom ASMs. Input and output sockets are to be used instead.

### 7.4.2 Settings

<b>General</b>	
Name	Automation
Description	
Reinstall	<input type="checkbox"/>
<b>Interfaces</b>	
Automation	Logic editor

#### **General**

You will find descriptions of the global settings (Name, Description, Reinstall, BACnet, WebUI) in [chapter 7.3. Global ASM settings](#).

# ABB i-bus<sup>®</sup> KNX Parameters

## Interfaces

### Automation

Open the logic editor for the Automation ASM by clicking the *Logic editor* button.

## Logic editor

### File menu

Save	Save can only be used after a change.
Import composite function block	Imports a user-defined function block (fbxml file). After import, the composite function block is shown at the bottom left in the list of function elements in <i>Own function blocks</i> .
Print	Options: <ul style="list-style-type: none"><li>• Print All</li><li>• Print Current Worksheet</li></ul> The size of the printout matches the scaling on the user interface.
Print Preview	Options: <ul style="list-style-type: none"><li>• Full Preview</li><li>• Previews the current worksheet</li></ul> The size of the print preview matches the scaling on the user interface.
Check	Provides an overview of free resources: <ul style="list-style-type: none"><li>• Elements (total number of function elements)</li><li>• Sockets used (number of socket I/Os)</li><li>• Web interfaces used (number of web I/Os)</li><li>• Download image size (volume of data downloaded to the device)</li></ul>
Settings	General settings for operating the device. <a href="#">More information</a>

# ABB i-bus<sup>®</sup> KNX

## Parameters

### Edit menu

Grid	Switches on and off the worksheet grid.
Create composite function block	Creates a composite function block from the selected logic. <a href="#">More information</a>
Cut/Copy/Paste	Standard functionality
Undo/Redo	Standard functionality 15 undoes/redoes are possible.

### Realtime menu

Real time device monitoring.

Enabling this function links the plug-in to the device and then shows the live status of the device logic.

The IP address for the connection is taken from the ETS settings.

### Simulation menu

Offline simulation of the defined logic.

[More information](#)

### Worksheet

The worksheet is where you create logical links.

- To rename the worksheet: double-click the tab field and overwrite it.

### Properties window

The Properties window is used to parametrize logic elements. In the *Name* field, you can enter a unique name for each logic element, and in the *Remark* field, specific information about it.

# ABB i-bus® KNX Parameters

## Monitor

Use the Monitor function to view the current states of the logic in the device in real time. The function requires a network connection to the device. To start the monitor, click the following icon:



The plug-in then tries to establish a connection to the logic controller. It takes the IP address from the ETS settings (Properties > "IP" tab).

While using Monitor mode, the "Monitor Mode" option in the application controller web user interface settings must be enabled. This is disabled by default for security reasons.

When a connection has been established, the current states of the input sockets, output sockets and the internal links are displayed.

Note that the Monitor function can only work if the logic in the device and the plug-in is the same.

## Simulation

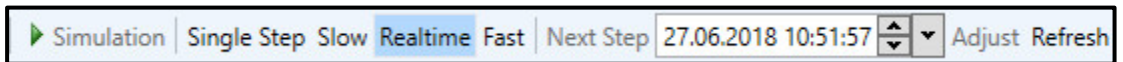

Simulation/Stop	Starts and stops the simulation.
Speeds:	Used to select simulation speeds. Important for simulating timer functions such as the Calendar function.
Single Step	Clicking <i>Next Step</i> starts a calculation cycle.
Slow	Around 50 times slower than real time.
Realtime	The simulation is in real time.
Fast	1 second in the simulation is 1 hour in real time.
Simulation time	Sets the simulation time and date. <i>Adjust</i> button: Applies the setting. <i>Refresh</i> button: Synchronizes the date and time with the real time of the PC.

# ABB i-bus<sup>®</sup> KNX

## Parameters

### Settings

#### **Engine Settings parameters**

Cycle time

Options:            200...65535 ms (unsigned integer)

Defines the minimum time for the logic engine calculation cycle

#### **Use persisting values**

Options:            No (checkbox cleared)  
                      Yes (checkbox selected)

- Yes: The device stores the internal information of certain function elements. To see which data are saved, please refer to the descriptions of the relevant function elements.

### Persisting values

#### **Power failure**

If the power fails (24 V DC or PoE) the device safeguards certain internally calculated values, e.g. staircase lighting time or the integral value of the PID controller. The device continues to operate for 20 to 60 seconds using backup power (depending on the processing power). If power is restored during this time, the device continues to operate normally.

If the power failure exceeds the backup time, the logic shuts down safely.

When power has been restored, the device restarts.

#### **Failure of the bus voltage**

If the bus voltage fails but the power supply is running, the device continues to operate normally and saves all internal values. Bus-dependent calculations such as the Calendar or Timer function also run normally, but no telegrams are sent.

On bus voltage recovery bus the ASM sockets are updated to their current values.

#### **ETS download**

After an ETS download, all internal information is saved and restored. This also applies to internally calculated values (e.g. staircase lighting time and the integral value of the PID controller).

If an element was removed from the previous parametrization, its internal value is discarded.

If an element was added, its internal value will be set to the default (usually 0).



# ABB i-bus<sup>®</sup> KNX Parameters

## Function elements

### ASM input socket (SOCKET IN)



Selects the ASM input socket based on the required main data point type. Values received are forwarded to the logic.

You can enter a unique name for the element in the *Name* field in the Properties window. The corresponding ASM input socket in the Linking view also has this name.

### Sending outputs

No.	DPT	Abbr.	Name	Visible	Description
1	Any	O	Output	Always	

### Parameters

Name	Value	Visible	Description
Data subtype	According to DPT	Always	Selects the data point type

# ABB i-bus® KNX Parameters

## ASM output socket (SOCKET OUT)

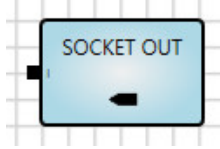

Selects the ASM output socket based on the required main data point type. Values from the logic are forwarded to other ASMs.

You can enter a unique name for the element in the *Name* field in the Properties window. The corresponding ASM output socket in the Linking view also has this name.

### Inputs

Nr.	DPT	Abbr.	Name	Visible	Description
1	Any	I	Input	Always	

### Parameters

Name	Value	Visible	Description
Data subtype	According to DPT	Always	Selects the data point type

# ABB i-bus<sup>®</sup> KNX Parameters

## Marker input (MARKER IN)



Markers are used for distant links. Links between worksheets are also possible.

A marker input is logically linked to a marker output; set the parameters for the connection in the Properties window.

A marker input can only be linked to exactly one marker output!

### Outputs

No.	DPT	Abbr.	Name	Visible	Description
1	Any	O	Output	Always	

### Parameters

Name	Value	Visible	Description
Linked to	List of all MARKER OUTs	Always	Selects the MARKER OUT to be linked to the MARKER IN

## Marker output (MARKER OUT)



Markers are used for distant links. Links between worksheets are also possible.

A marker output is logically linked to one or more marker inputs; set the parameters for the connection in the properties window.

### Inputs

No.	DPT	Abbr.	Name	Visible	Description
1	Any	I	Input	Always	

### Parameters

Name	Value	Visible	Description
Linked to	List of all MARKER INs	Always	Selects the MARKER IN to be linked to the MARKER OUT

# ABB i-bus<sup>®</sup> KNX Parameters

## AND (AND)

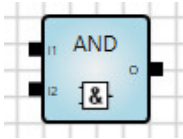

Logical AND operator.

### Inputs

No.	DPT	Abbr.	Name	Visible	Description
1	1 bit	I <sub>1</sub>	Input	Always	
2	1 bit	I <sub>2</sub>	Input	Always	
3-16	1 bit	I <sub>n</sub>	Input	Parametrizable	n = 3...16

### Outputs

No.	DPT	Abbr.	Name	Visible	Description
1	1 bit	O	Output	Always	

An AND element can be easily inverted to a NAND element by double-clicking the output.

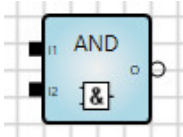

### Parameters

Name	Value	Visible	Description
Input count	2...16	Always	

### Function

Whenever a telegram is received the output starts a recalculation independently if the value has changed. The output is true (1) if all inputs are true (1).

I <sub>1</sub>	I <sub>2</sub>	O
0	0	0
0	1	0
1	0	0
1	1	1

### Other

Inputs not connected are treated as if they did not exist.

# ABB i-bus<sup>®</sup> KNX Parameters

## OR (OR)

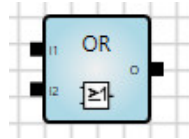

Logical OR operator.

### Inputs

No.	DPT	Abbr.	Name	Visible	Description
1	1 bit	I <sub>1</sub>	Input	Always	
2	1 bit	I <sub>2</sub>	Input	Always	
3-16	1 bit	I <sub>n</sub>	Input	Parametrizable	n = 3...16

### Outputs

No.	DPT	Abbr.	Name	Visible	Description
1	1 bit	O	Output	Always	

An OR element can be easily inverted to a NOR element by double-clicking the output.

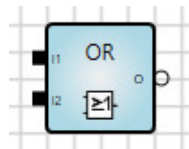

### Parameters

Name	Value	Visible	Description
Input count	2...16	Always	

### Function

Whenever a telegram is received the output starts a recalculation independently if the value has changed. The output is true (1) if at least one input is true (1).

I <sub>1</sub>	I <sub>2</sub>	O
0	0	0
0	1	1
1	0	1
1	1	1

### Other

Inputs not connected are treated as if they did not exist.

# ABB i-bus<sup>®</sup> KNX Parameters

## XOR (XOR)

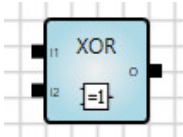

Logical XOR operator (exclusive OR).

### Inputs

No.	DPT	Abbr.	Name	Visible	Description
1	1 bit	I <sub>1</sub>	Input	Always	
2	1 bit	I <sub>2</sub>	Input	Always	
3-16	1 bit	I <sub>n</sub>	Input	Parametrizable	n = 3...16

### Outputs

No.	DPT	Abbr.	Name	Visible	Description
1	1 bit	O	Output	Always	

A XOR element can be easily inverted to a XNOR element by double-clicking the output.

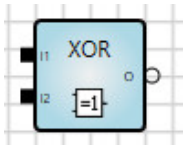

### Parameters

Name	Value	Visible	Description
Input count	2...16	Always	

### Function

Whenever a telegram is received the output starts a recalculation independently if the value has changed. The output is true (1) if there is an odd number of true (1) inputs.

I <sub>1</sub>	I <sub>2</sub>	I <sub>3</sub>	O
0	0	0	0
0	0	1	1
0	1	0	1
0	1	1	0
1	0	0	1
1	0	1	0
1	1	0	0
1	1	1	1

### Other

Inputs not connected are treated as if they did not exist. If only one input is linked, the output value is the same as the input value.

# ABB i-bus<sup>®</sup> KNX Parameters

## NOT (NOT)

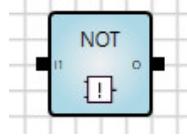

Logical NOT operator.

### Note

1-bit inputs and outputs can be inverted by double-clicking the related input/output.

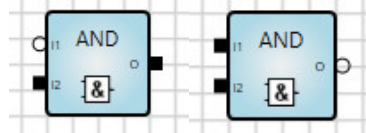

### Inputs

No.	DPT	Abbr.	Name	Visible	Description
1	1 bit	I1	Input	Always	

### Outputs

No.	DPT	Abbr.	Name	Visible	Description
1	1 bit	O	Output	Always	

### Parameters

None

### Function

Whenever a telegram is received the output starts a recalculation independently if the value has changed. The input value is output negated.

I	O
0	1
1	0

# ABB i-bus<sup>®</sup> KNX Parameters

## 1ofN (ONE-HOT)

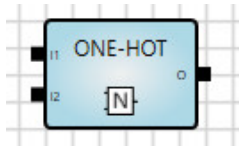

Logical 1ofN operator.

### Inputs

No.	DPT	Abbr.	Name	Visible	Description
1	1 bit	I <sub>1</sub>	Input	Always	
2	1 bit	I <sub>2</sub>	Input	Always	
3-16	1 bit	I <sub>n</sub>	Input	Parametrizable	n = 3...16

### Outputs

No.	DPT	Abbr.	Name	Visible	Description
1	1 bit	O	Output	Always	

### Parameters

Name	Value	Visible	Description
Input count	2...16	Always	

### Function

Whenever a telegram is received the output starts a recalculation independently if the value has changed. The output is true (1) if exactly one input is true (1).

I <sub>1</sub>	I <sub>2</sub>	I <sub>3</sub>	O
0	0	0	0
0	0	1	1
0	1	0	1
0	1	1	0
1	0	0	1
1	0	1	0
1	1	0	0
1	1	1	0



# ABB i-bus<sup>®</sup> KNX Parameters

## Application example

You want to ensure that from a set of outputs, exactly one has the value 1 while the other outputs are 0. The circuit shown ensures that this is the case.

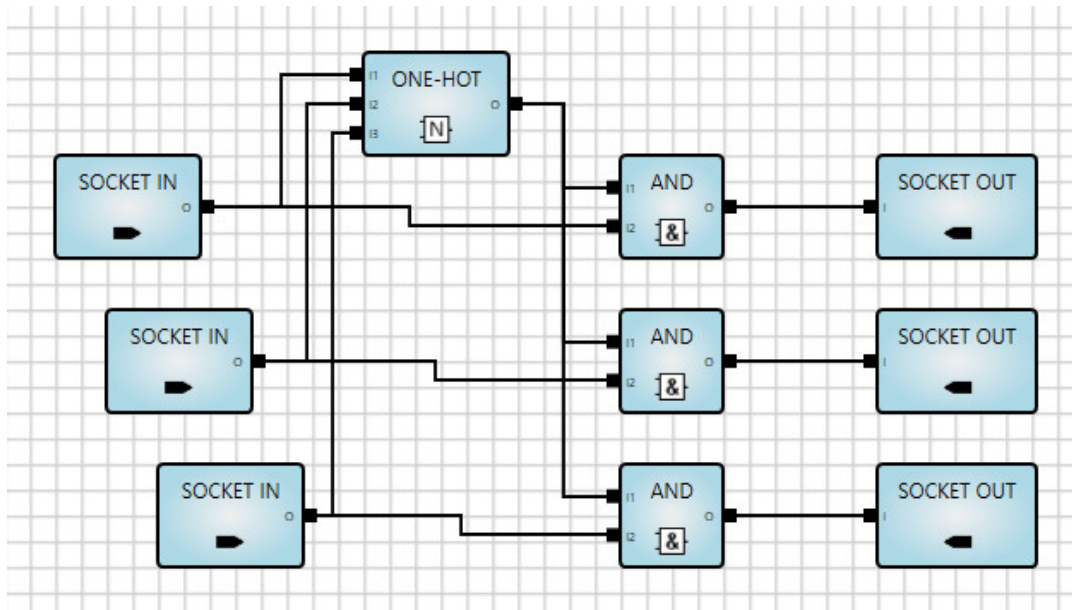

If more than one of the three input values is 1, this results in a 1ofN operator is equal to 0. The AND logic gates therefore force the three output values to 0.

## Other

Inputs not connected are treated as if they did not exist.

# ABB i-bus<sup>®</sup> KNX Parameters

## Greater Than (GREATER)

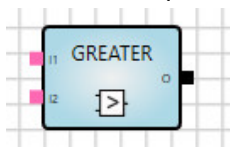

Comparison of two input values. Both inputs can also be linked with fixed values (constant).

### Inputs

No.	DPT	Abbr.	Name	Visible	Description
1	Numerical value	I <sub>1</sub>	Input	Always	
2	Same as input 1	I <sub>2</sub>	Input	Parametrizable	

### Outputs

No.	DPT	Abbr.	Name	Visible	Description
1	1 bit	O	Output	Always	

### Parameters

Name	Value	Visible	Description
In 2	Checkbox	Always	
	Numerical value	If the checkbox is cleared	Data type as for input 1

### Function

The output is 1 if I<sub>1</sub> is greater than I<sub>2</sub>.

The output is 0 if I<sub>1</sub> is less than or equal to I<sub>2</sub>.

Whenever a telegram is received the output starts a recalculation independently if the value has changed.

# ABB i-bus<sup>®</sup> KNX Parameters

## Lower Than (LOWER)

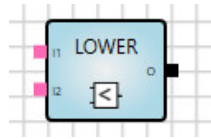

Comparison of two input values. Both inputs can also be linked with fixed values (constant).

### Inputs

No.	DPT	Abbr.	Name	Visible	Description
1	Numerical value	I <sub>1</sub>	Input	Always	
2	Same as input 1	I <sub>2</sub>	Input	Parametrizable	

### Outputs

No.	DPT	Abbr.	Name	Visible	Description
1	1 bit	O	Output	Always	

### Parameters

Name	Value	Visible	Description
In 2	Checkbox	Always	
	Numerical value	If the checkbox is cleared	Data type as for input 1

### Function

The output is 1 if I<sub>1</sub> is less than I<sub>2</sub>.

The output is 0 if I<sub>1</sub> is greater than or equal to I<sub>2</sub>.

Whenever a telegram is received the output starts a recalculation independently if the value has changed.

# ABB i-bus<sup>®</sup> KNX Parameters

## Equal (EQUAL)

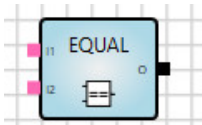

Comparison of two input values. Both inputs can also be linked with fixed values (constant).

### Inputs

No.	DPT	Abbr.	Name	Visible	Description
1	Numerical value	I <sub>1</sub>	Input	Always	
2	Same as input 1	I <sub>2</sub>	Input	Parametrizable	

### Outputs

No.	DPT	Abbr.	Name	Visible	Description
1	1 bit	O	Output	Always	

### Parameters

Name	Value	Visible	Description
In 2	Checkbox	Always	
	Numerical value	If the checkbox is cleared	Data type as for input 1

### Function

The output is 1 if I<sub>1</sub> is equal to I<sub>2</sub>.

The output is 0 if I<sub>1</sub> is not equal to I<sub>2</sub>.

Whenever a telegram is received the output starts a recalculation independently if the value has changed.

# ABB i-bus<sup>®</sup> KNX Parameters

## Not Equal (NOT EQUAL)

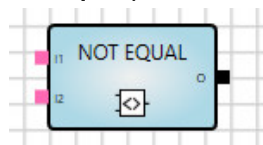

Comparison of two input values. Both inputs can also be linked with fixed values (constant).

### Inputs

No.	DPT	Abbr.	Name	Visible	Description
1	Numerical value	I <sub>1</sub>	Input	Always	
2	Same as input 1	I <sub>2</sub>	Input	Parametrizable	

### Outputs

No.	DPT	Abbr.	Name	Visible	Description
1	1 bit	O	Output	Always	

### Parameters

Name	Value	Visible	Description
In 2	Checkbox	Always	
	Numerical value	If the checkbox is cleared	Data type as for input 1

### Function

The output is 1 if I<sub>1</sub> is not equal to I<sub>2</sub>.

The output is 0 if I<sub>1</sub> is equal to I<sub>2</sub>.

Whenever a telegram is received the output starts a recalculation independently if the value has changed.

# ABB i-bus<sup>®</sup> KNX Parameters

## Greater or equal (GREATER/EQUAL)

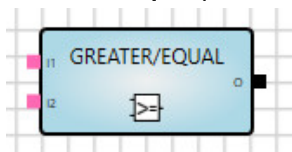

Comparison of two input values. Both inputs can also be linked with fixed values (constant).

### Inputs

No.	DPT	Abbr.	Name	Visible	Description
1	Numerical value	I <sub>1</sub>	Input	Always	
2	Same as input 1	I <sub>2</sub>	Input	Parametrizable	

### Outputs

No.	DPT	Abbr.	Name	Visible	Description
1	1 bit	O	Output	Always	

### Parameters

Name	Value	Visible	Description
In 2	Checkbox	Always	
	Numerical value	If the checkbox is cleared	Data type as for input 1

### Function

The output is 1 if I<sub>1</sub> is greater than or equal to I<sub>2</sub>.

The output is 0 if I<sub>1</sub> is less than I<sub>2</sub>.

Whenever a telegram is received the output starts a recalculation independently if the value has changed.

# ABB i-bus<sup>®</sup> KNX Parameters

## Lower or Equal (LOWER/EQUAL)

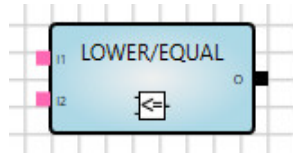

Comparison of two input values. Both inputs can also be linked with fixed values (constant).

### Inputs

No.	DPT	Abbr.	Name	Visible	Description
1	Numerical value	I <sub>1</sub>	Input	Always	
2	Same as input 1	I <sub>2</sub>	Input	Parametrizable	

### Outputs

No.	DPT	Abbr.	Name	Visible	Description
1	1 bit	O	Output	Always	

### Parameters

Name	Value	Visible	Description
In 2	Checkbox	Always	
	Numerical value	If the checkbox is cleared	Data type as for input 1

### Function

The output is 1 if I<sub>1</sub> is less than or equal to I<sub>2</sub>.

The output is 0 if I<sub>1</sub> is greater than I<sub>2</sub>.

Whenever a telegram is received the output starts a recalculation independently if the value has changed.

# ABB i-bus<sup>®</sup> KNX Parameters

## Minimum/Maximum (MIN/MAX)



Finds the largest or smallest of up to 16 values. Inputs can also be linked with fixed values (constant).

### Inputs

No.	DPT	Abbr.	Name	Visible	Description
1	1 bit	F	Function	Parametrizable	
2	Any	I <sub>1</sub>	Input	Always	
3	Any	I <sub>2</sub>	Input	Always	
4-16	Any	I <sub>n</sub>	Input	Parametrizable	n = 3...16

### Outputs

No.	DPT	Abbr.	Name	Visible	Description
1	1 bit	O	Output	Always	

### Parameters

Name	Value	Visible	Description
Input count	2...16	Always	

### Input parameters

Name	Value	Visible	Description
Min	Checkbox	Always	Enables input F on the element
	Checkbox	If the checkbox is cleared	1 = Minimum 0 = Maximum

### Function

Input F defines, if MIN or MAX function is activated.

If F = 0, the output sends the largest input value (I1-I16). Function MAX is activated.

If F = 1, the output sends the smallest input value (I1-I16). Function MIN is activated.

The output sends:

- On a value change at the output (new input values will be set).
- When input F receives a value

### Other

If only one input is linked, the output value is the same as the input value.



# ABB i-bus<sup>®</sup> KNX Parameters

## Multiplexer, 2 to 1 (1-MUX)

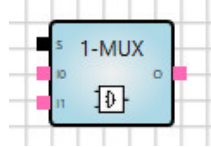

Selects a value from two input values.

### Inputs

No.	DPT	Abbr.	Name	Visible	Description
1	1 bit	S	Select	Always	
2	Any	I <sub>0</sub>	Input	Always	
3	Any	I <sub>1</sub>	Input	Always	

### Outputs

No.	DPT	Abbr.	Name	Visible	Description
1	Any	O	Output	Always	

### Parameters

Name	Value	Visible	Description
Send trigger	Yes <u>No</u>	Always	Checkbox: Yes: The output sends when Select receives a value. No: The output does not send when Select receives a value.

### Function

If Select has the value 1, input I<sub>1</sub> is sent to the output. If Select has the value 0, input I<sub>0</sub> is sent to the output.

Values received on unselected inputs are stored until the input is selected.

Whenever a telegram is received the output starts a recalculation independently if the value has changed.

# ABB i-bus<sup>®</sup> KNX Parameters

## Application example

This element can also be used as a send trigger.

In the example below, the result of the MIN/MAX element is always triggered for sending when the "Update" input receives a telegram. The *Send trigger* parameter in 1-MUX must be activated.

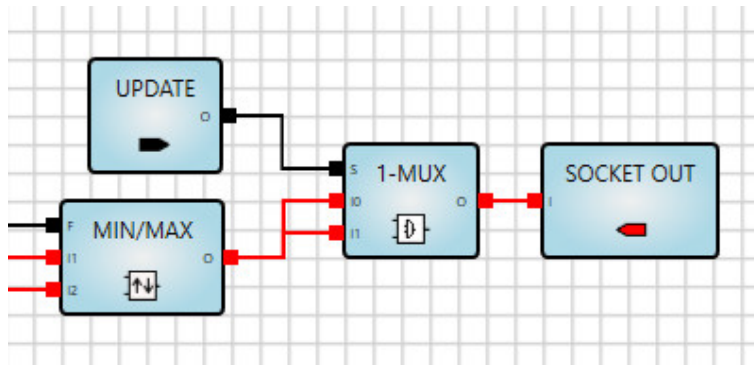

## Other

If an unlinked input is selected, the output value remains unchanged.

# ABB i-bus<sup>®</sup> KNX Parameters

## Multiplexer, n-fold (n-MUX)

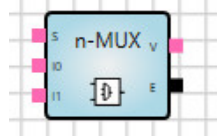

Selects a value from up to 16 input values.

### Inputs

No.	DPT	Abbr.	Name	Visible	Description
1	1 byte unsigned 2 bytes unsigned 4 bytes unsigned	S	Select	Always	
2	Any	I <sub>0</sub>	Input	Always	
3	Any	I <sub>1</sub>	Input	Always	
4-17	Any	I <sub>n</sub>	Input	Parametrizable	n = 2...15

### Outputs

No.	DPT	Abbr.	Name	Visible	Description
1	Any	V	Value	Always	
2	1 bit	E	Error	Always	

### Parameters

Name	Value	Visible	Description
Input count	2...16	Always	

### Function

The Select value defines which input value is sent to the output.

Values received on unselected inputs are stored until the input is selected.

The output is recalculated and updated every time if any of the inputs or *Select* receives a value.

#### Note

*Select* starts with the value 0.

### Exception

If the value on the selected input or on the selector is invalid, the output will not react.

The output E (Error) is set to 1. It resets to 0 as soon as both *Select* and the selected input have valid values.

### Other

If an unlinked input is selected, the output value remains unchanged.

# ABB i-bus<sup>®</sup> KNX Parameters

## Gate (GATE)

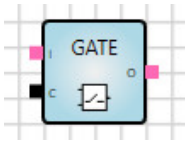

Disables or enables the transmission of values.

If the gate element is disabled, the output remains unchanged and will not trigger a recalculation.

### Inputs

No.	DPT	Abbr.	Name	Invertible	Visible	Description
1	Any	I	Input	No	Always	
2	1 bit	C	Control	Yes	Always	Disables/enables the output

### Outputs

No.	DPT	Abbr.	Name	Invertible	Visible	Description
1	Any	O	Output	No	Always	

### Parameters

Name	Value	Visible	Description
Control triggers calculation	<u>Yes</u> No	Always	Yes: The output sends a value every time a value is received on the Control input.

### Function

Control = 1 (true): The output sends every time an input value is received (enabled)

Control = 0 (false): The output does not send (disabled)

### Other

If the Control input is not connected, the transmission of values through the gate element is enabled.

# ABB i-bus<sup>®</sup> KNX Parameters

## Filter (FILTER)

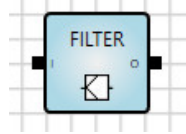

The filter blocks 1-bit telegram values (0 or 1).

### Inputs

No.	DPT	Abbr.	Name	Invertible	Visible	Description
1	1 bit	I	Input	Yes	Always	

### Outputs

No.	DPT	Abbr.	Name	Invertible	Visible	Description
1	1 bit	O	Output	Yes	Always	

### Parameters

Name	Value	Visible	Description
Blocked Value	None (no filter)	Always	None (no filter)
	0		0 (value 0 is blocked)
	1		1 (value 1 is blocked)

### Function

The output sends when the input receives a value that is not blocked.

If the *None* option is selected for the *Blocked Value* parameter, the filter element forwards all values received.

### Application examples

- A presence detector sends 1-bit values. After a defined time it sends the value 0 to switch off the light. Other appliances are not to react to this value 0 because they have their own timer control.
- A push-button or a key card triggers the sending of 1-bit values, 1 or 0. The two values are to trigger different actions.
- The staircase lighting will switch off after receiving the value 0. If this action is not required, the value 0 can be blocked by a filter.

### Other

Inputs not connected are treated as if they did not exist.

# ABB i-bus<sup>®</sup> KNX Parameters

## Addition (ADD)



Sums up to 16 input values.

### Inputs

No.	DPT	Abbr.	Name	Visible	Description
1	8 bits or higher	Aug	Augend	Always	
2	Same as input 1	Ad <sub>1</sub>	Addend	Always	
3-16	Same as input 1	Ad <sub>n</sub>	Addend	Parametrizable	n = 2...15

### Outputs

No.	DPT	Abbr.	Name	Visible	Description
1	Same as input 1	S	Sum	Always	
2	1 bit	Ov	Overflow	Always	Indicates an overflow

### Parameters

Name	Value	Visible	Description
Input count	2...16	Always	

### Function

Whenever a telegram is received the output starts a recalculation independently if the value has changed.

An overflow will occur if the calculated value is outside the DPT range:

- If the calculated value is greater than the maximum DPT value:
  - S = 0
  - Ov = 1 (true)
- If the calculated value is less than the minimum DPT value:
  - S = 0
  - Ov = 1 (true)
- If the calculated value is within the valid range of the DPT:
  - S = Sum of all linked input values
  - Ov = 0 (false)

### Other

Inputs not connected are treated as if they did not exist.

# ABB i-bus<sup>®</sup> KNX Parameters

## Multiplication (MULT)

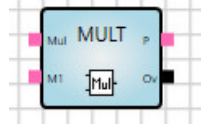

Multiplies up to 16 input values.

### Inputs

No.	DPT	Abbr.	Name	Visible	Description
1	8 bits or higher	Mul	Multiplicand	Always	
2	Same as input 1	M <sub>1</sub>	Multiplier	Always	
3-16	Same as input 1	M <sub>n</sub>	Multiplier	Parametrizable	n = 2...15

### Outputs

No.	DPT	Abbr.	Name	Visible	Description
1	Same as input 1	P	Product	Always	
2	1 bit	Ov	Overflow	Always	Indicates an overflow

### Parameters

Name	Value	Visible	Description
Input count	2...16	Always	

### Function

Whenever a telegram is received the output starts a recalculation independently if the value has changed.

An overflow will occur if the calculated value is outside the DPT range:

- If the calculated value is greater than the maximum DPT value:
  - P = 0
  - Ov = 1 (true)
- If the calculated value is less than the minimum DPT value:
  - P = 0
  - Ov = 1 (true)
- If the calculated value is within the valid range of the DPT:
  - P = Product of all linked input values
  - Ov = 0 (false)

### Other

Inputs not connected are treated as if they did not exist.

# ABB i-bus<sup>®</sup> KNX Parameters

## Subtraction (SUB)

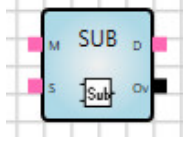

Subtracts one input value (subtrahend) from another (minuend).

### Inputs

No.	DPT	Abbr.	Name	Visible	Description
1	8 bits or higher	M	Minuend	Always	
2	Same as input 1	S	Subtrahend	Always	

### Outputs

No.	DPT	Abbr.	Name	Visible	Description
1	Same as input 1	D	Difference	Always	
2	1 bit	Ov	Overflow	Always	Indicates an overflow

### Parameters

None

### Function

Whenever a telegram is received the output starts a recalculation independently if the value has changed.

An overflow will occur if the calculated value is outside the DPT range:

- If the calculated value is greater than the maximum DPT value:
  - D = 0
  - Ov = 1 (true)
- If the calculated value is less than the minimum DPT value:
  - D = 0
  - Ov = 1 (true)
- If the calculated value is within the valid range of the DPT:
  - D = Difference between the two input values (minuend - subtrahend)
  - Ov = 0 (false)

### Other

Inputs not connected are treated as if they did not exist and are set to 0.



# ABB i-bus<sup>®</sup> KNX Parameters

## Division (DIV)

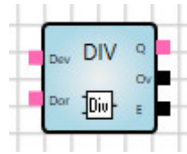

Divides one input value (dividend) by another (divisor).

### Inputs

No.	DPT	Abbr.	Name	Visible	Description
1	8 bits or higher	Dev	Dividend	Always	
2	Same as input 1	Dor	Divisor	Always	

### Outputs

No.	DPT	Abbr.	Name	Visible	Description
1	Same as input 1	Q	Quotient	Always	
2	1 bit	Ov	Overflow	Always	Indicates an overflow
3	1 bit	E	Error	Always	Indicates a division by 0

### Parameters

None

### Function

Whenever a telegram is received the output starts a recalculation independently if the value has changed.

An overflow will occur if the calculated value is outside the DPT range:

- If the calculated value is greater than the maximum DPT value:
  - Q = 0
  - Ov = 1 (true)
  - E = 0 (false)
- If the calculated value is less than the minimum DPT value:
  - Q = 0
  - Ov = 1 (true)
  - E = 0 (false)
- If the calculated value is within the valid range of the DPT:
  - Q = Quotient of the two input values (dividend: divisor)
  - Ov = 0 (false)
  - E = 0 (false)
- Value of the divisor = 0:
  - Q = 0
  - Ov = 0 (false)
  - E = 1 (true)

### Other

Inputs not connected are treated as if they did not exist.

# ABB i-bus<sup>®</sup> KNX Parameters

## Modulo (MOD)

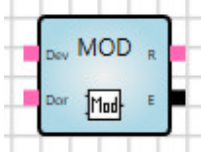

Calculates the remainder from dividing one input value (dividend) by another (divisor).

### Inputs

No.	DPT	Abbr.	Name	Visible	Description
1	8 bits or higher	Dev	Dividend	Always	
2	Same as input 1	Dor	Divisor	Always	

### Outputs

No.	DPT	Abbr.	Name	Visible	Description
1	Same as input 1	R	Remainder	Always	Remainder of the division
2	1 bit	E	Error	Always	Indicates a division by 0

### Parameters

None

### Function

Whenever a telegram is received the output starts a recalculation independently if the value has changed.

Remainder and error:

- The dividend is divided by the divisor and the value from the division is within the valid range of the DPT. Output of the remainder:
  - R = value
  - E = 0 (false)
- The input is not connected or the value of the divisor = 0:
  - R = 0
  - E = 1 (true)

### Other

Inputs not connected are treated as if they did not exist.

# ABB i-bus<sup>®</sup> KNX Parameters

## Delay (DELAY)

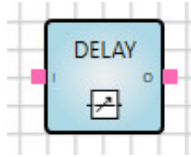

Values received are forwarded after a defined delay.

### Inputs

No.	DPT	Abbr.	Name	Visible	Description
1	Any	I	Input	Always	
2	4 bytes signed	D	Delay	Parametrizable	Value in seconds; according to KNX DPT 13.100

### Outputs

No.	DPT	Abbr.	Name	Visible	Description
1	Any	O	Output	Always	

### Parameters

Name	Value	Visible	Description
Delay	Checkbox	Always	Enables input <i>D</i> (Delay)
	hh:mm:ss Default value: 00:00:00	If the checkbox is cleared	Parameter and socket according to KNX DPT 13.100. Range from 00:00:00 to 99:59:59. Values outside the range are set to the minimum or maximum value respectively.

If the Delay checkbox is selected, the time value field is not visible.

### Function

If a new value is received during the delay, the delay restarts and the old value is discarded.

The timer resets to zero and restarts (retrigger).

Once the delay time has elapsed, the output is updated to the last input value.

On enabling the delay using the checkbox, note the following:

- If input *D* is not connected, the delay will automatically be set to 0.

# ABB i-bus<sup>®</sup> KNX

## Parameters

### **Application examples**

- Delayed transmission of scene values.
- A motion sensor monitors corridor lighting. As soon as the sensor detects a movement, the lighting in the corridor is gradually switched on (e.g. every 500 ms).
- Monitoring receipt of cyclical telegrams.

### **Bus voltage failure, download and restart**

In the event of bus voltage failure, the timer stops and the input value is discarded. Therefore the output sends no value on restart.

### **Other**

Inputs not connected are treated as if they did not exist.

# ABB i-bus® KNX Parameters

## Staircase lighting (STAIR LIGHT)



A timer that automatically resets the output to 0 (false) after a specified time has elapsed.

### Inputs

No.	DPT	Abbr.	Name	Visible	Description
1	1 bit	Tr	Trigger	Always	
2	4 bytes unsigned	T	On-time	Parametrizable	Value in seconds; according to KNX DPT 13.100
3	1 bit	R	Retrigger	Parametrizable	1 = yes 0 = no

### Outputs

No.	DPT	Abbr.	Name	Invertible	Visible	Description
1	1 bit	O	Output	Yes	Always	1 (true), as long as the timer is running

### Input parameters

Name	Value	Visible	Description
On-time	Checkbox	Always	Activates input <i>T</i> (On-time)
	Unsigned integer in [s]	If the checkbox is cleared	
Reset	Checkbox	Always	Activates input <i>R</i> (Retrigger)
	Checkbox 2	If Checkbox 1 is cleared	If the <i>Retrigger</i> input receives a value, the timer resets to 0

If the *On-time* checkbox is selected, the time value field is not visible. The same applies to the *Retrigger* checkbox.

# ABB i-bus<sup>®</sup> KNX

## Parameters

### Function

- Input receives a 1 (true):
  - Output = 1 (true)
  - Timer restarts
- Input receives a 0 (false):
  - Output = 0 (false)
  - Timer stops
- **If the timer reaches the On-time:**
  - Output = 0 (false)
  - Timer stops
- **Retrigger:**
- If Retrigger = 1 (true):
  - If the input receives a 1 the timer restarts
- If Retrigger = 0 (false):
  - If the timer is running and the input receives a 1 (true) it ignores it. The timer continues running.

### Exceptions

- If the *On-time* input is not connected, the element uses the value 00:00:30.
- If the *On-time* input is negative, the element uses the value 00:00:00.
- If the *On-time* input has a value of 00:00:00, the output is always 0.

### Bus voltage failure, download and restart

The internal timer value is saved. This value is restored on restart.

# ABB i-bus<sup>®</sup> KNX Parameters

## Calendar, simple (CALENDAR\_S)



Simple comparison of a start time and an end time.

Triggers daily events (for the whole day or at specific times).

The output value is 1 if the device time is between *Start* and *End* and the other conditions are met.

### Inputs

No.	DPT	Abbr.	Name	Visible	Description
1	Time	S	Start	Parametrizable	
2	Time	E	End	Parametrizable	
3	1 bit	A	Active	Parametrizable	Value 0 disables the element, the output remains unchanged
4	1 bit	WT	Whole time	Parametrizable	Output is always 1

### Outputs

No.	DPT	Abbr.	Name	Visible	Description
1	1 bit	O	Output	Always	

### Parameters

Name	Value	Visible	As input*
Start	Time (hh:mm:ss) Default = 00:00:00	Always	Yes
End	Time (hh:mm:ss) Default = 00:00:00	Always	Yes
Active	Checkbox	Always	Yes
Whole time	Checkbox	Always	Yes

\* As input = if yes: parameter is input.

# ABB i-bus<sup>®</sup> KNX

## Parameters

### Function

- If the current time is between the start time and end time AND the Active input = 1 (true):
  - Output = 1 (true)
- Start time greater than end time:
  - Output = 0 (false)
- *Active* input = 0 (false):
  - The output remains unchanged.
- *Active* input = 1 (true):
  - The output is recalculated and updated accordingly.
- *Whole time* input = 1 (true) AND *Active* input = 1 (true):
  - Output = 1 (true)
  - The element reacts as if the start time and end time were both 00:00.

Whenever a telegram is received the output starts a recalculation independently if the value has changed.

### Exception handling and startup behavior

The element does not work if:

- The system time is invalid.
- Start time or end time have invalid or no values.

#### **Note**

The function element only works with start and end time. The weekdays contained in the DPT are ignored.



# ABB i-bus<sup>®</sup> KNX Parameters

## Calendar (CALENDAR)

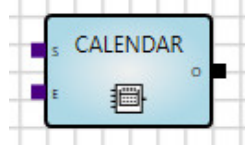

Used for events that occur periodically or on specific dates. A wide variety of settings is possible.

The calendar uses the logic device's internal clock. It can be changed via the bus (group objects).

The output value is 1 if the device time is between Start and End and the other conditions are met.

### Inputs

No.	DPT	Abbr.	Name	Visible	Description
1	Time	S	Start	Parametrizable	Defines the start time; refers to corresponding parameters
2	Time	E	End	Parametrizable	Defines the end time; refers to corresponding parameters
3	1 bit	A	Active	Parametrizable	If Active = 0 the output is always 0; refers to corresponding parameters
4	1 bit	WT	Whole time	Parametrizable	If Whole time = 1, Start = 00:00:00 and End = 24:00:00; refers to corresponding parameters
5-7					Recurrence (Daily, Weekly, Monthly, Yearly); see below
8	Date	B	Begin	Parametrizable	Defines the date for activation of the calendar element (sets a duration); before this date, the output value is 0; refers to corresponding parameters
9	Date	U	Until	Parametrizable	Defines the date for deactivation of the calendar element (sets a duration); after this date, the output value is 0; refers to corresponding parameters

# ABB i-bus® KNX Parameters

## Daily recurrence input

No.	DPT	Abbr.	Name	Visible	Description
5	1 byte unsigned	D	Day	Parametrizable	Every ... day(s)

## Weekly recurrence input

No.	DPT	Abbr.	Name	Visible	Description
5	1 byte unsigned	D	Day	Parametrizable	Bit input: defines the weekday(s) when the element is active. Bit 0 = Monday ... Bit 6 = Sunday
6	1 byte unsigned	W	Week	Parametrizable	Every ... week on

## Monthly recurrence input

No.	DPT	Abbr.	Name	Visible	Description
5	1 byte unsigned	D	Day	Parametrizable	Day ... of every
6	1 byte unsigned	M	Month	Parametrizable	... month

## Yearly recurrence input

No.	DPT	Abbr.	Name	Visible	Description
5	1 byte unsigned	D	Day	Parametrizable	Day ...
6	1 byte unsigned	M	Month	Parametrizable	Month (January – December)
7	1 byte unsigned	Y	Year	Parametrizable	Every ... year

## Outputs

No.	DPT	Abbr.	Name	Visible	Description
5	1 bit	O	Output	Always	

# ABB i-bus<sup>®</sup> KNX Parameters

## Parameters

The *Time* section specifies the time of day when the output has the value 1. At all other times the output has the value 0.

The *Recurrence* section specifies the days on which the element is active. On these days the output has the value 1. On all other days the output has the value 0.

### Note

Recurrence *Every ... day(s)*, *Every ... week(s) on*, *Day ... of every ... month(s)*, *Every ... year(s)* starts on the date set in the *Duration* section.

The *Duration* section specifies the dates between which the element is active.

All the parameters can also be set via inputs. Selecting the corresponding *As input* checkbox activates the inputs.

## Time section parameters

Time

Start	<input type="text" value="00:00:00"/>	<input checked="" type="checkbox"/>	As input
End	<input type="text" value="00:00:00"/>	<input checked="" type="checkbox"/>	As input
Whole time	<input type="checkbox"/>	<input type="checkbox"/>	As input
Active	<input checked="" type="checkbox"/>	<input type="checkbox"/>	As input

Parameter name	Value	Description
Start	Time of day in minutes, default = 00:00:00	Sets the start time
End	Time of day in minutes, default = 00:00:00	Sets the end time
Whole time	1 bit, default = false (0)	Sets a whole time
Active	1 bit, default = false (0)	Activates/deactivates the element

# ABB i-bus® KNX Parameters

## Recurrence section parameters – Daily

Recurrence cycle in days.

Recurrence

Daily
  Every    day(s)
  As input

Weekly
  Every weekday

Monthly

Yearly

Parameter name	Value	Description
Every ... day(s)	Optional 1...500, default = 1	The element is activated on specific days, e.g. every 4th day. <i>Every ... day(s)</i> and <i>Every weekday</i> are mutually exclusive options.
Every weekday	Optional	See above. The element is active from Monday to Sunday only.

### **i** Note

*Every ... day(s)* starts from the date set in the *Duration* section.

# ABB i-bus<sup>®</sup> KNX Parameters

## Recurrence section parameters – Weekly

Recurrence cycle in weeks.

Days of the week on which an event should be triggered every x weeks.

**Recurrence**

Daily    Recur every  week(s) on:  As input

Weekly   
  Monday     Friday     As input  
 Tuesday     Saturday

Monthly     Wednesday     Sunday

Yearly     Thursday

Parameter name	Value	Description
Every ... week(s) on:	1...500, default = 1	The element is activated in specific weeks, e.g. every 3rd week
Monday...Sunday	1 bit, default = false (0)	Parameters from <i>Monday to Sunday</i>

**Note**

*Every ... week(s)* starts from the date set in the *Duration* section.

# ABB i-bus® KNX Parameters

## Recurrence section parameters – Monthly

Recurrence cycle in months.

The day of the month on which an event should be triggered every x months.

Recurrence

Daily
 Day  of every
 As input

Weekly
  month(s)
 As input

Monthly

Yearly

Parameter name	Value	Description
Day ... of every	1...31, default = 1	The element is activated on a specific day in a specific month, e.g. every 3rd day of the month
... month(s)	1...500, default = 1	The element is activated in specific months, e.g. every 3rd month

### **i** Note

... month(s) starts from the date set in the *Duration* section.

# ABB i-bus<sup>®</sup> KNX Parameters

## Recurrence section parameters – Yearly

Recurrence cycle in years.

The day of a month on which an event should be triggered every x years.

**Recurrence**

Daily
  Weekly
  Monthly
  Yearly

Recur every  year(s)  As input

On day  April  As input

Parameter name	Value	Description
Recur every ... year	1...500, default = 1	The element is activated in specific years, e.g. every 3rd year
On day ...	1...31, default = 1	See above. This defines the day of the month
January – December	January – December	See above. This defines the month

### **ⓘ Note**

*Recur every ... year(s)* starts on the date set in the *Duration* section.

# ABB i-bus<sup>®</sup> KNX Parameters

## Duration section parameters

Before the start date the calendar function is inactive.

After the end data the calendar function is inactive. If no end date is defined, the calendar function is active from the start date onward.

**Duration**

Start    As input

End  No End  
 End at Date  
   As input

Parameter name	Value	Description
Start	Calendar day selection Default = 01.01.2016	Before this date the element is inactive.
No End	Optional	<i>No End</i> and <i>End at Date</i> are mutually exclusive. Selecting <i>No End</i> activates the element indefinitely.
End at Date:	Optional Calendar day selection Default = 01.01.2040	See above. After this date the element is inactive.



# ABB i-bus<sup>®</sup> KNX Parameters

## Selecting "As input"

The settings concerned are disabled and the parameters can be set via the inputs.

Time		
Start	08:00:00	<input checked="" type="checkbox"/> As input
End	18:00:00	<input checked="" type="checkbox"/> As input
Whole time	<input type="checkbox"/>	<input type="checkbox"/> As input
Active	<input checked="" type="checkbox"/>	<input type="checkbox"/> As input

Recurrence		
<input type="radio"/> Daily	Recur every 1 week(s) on:	<input checked="" type="checkbox"/> As input
<input checked="" type="radio"/> Weekly	<input type="checkbox"/> Monday <input type="checkbox"/> Friday	<input checked="" type="checkbox"/> As input
<input type="radio"/> Monthly	<input type="checkbox"/> Tuesday <input type="checkbox"/> Saturday	
<input type="radio"/> Yearly	<input type="checkbox"/> Wednesday <input type="checkbox"/> Sunday	
	<input type="checkbox"/> Thursday	

Duration		
Start	01.01.1990	<input checked="" type="checkbox"/> As input
End	<input type="radio"/> No End	
	<input checked="" type="radio"/> End at Date	
	01.01.1990	<input checked="" type="checkbox"/> As input

## Startup behavior

The element will not be active unless a valid date and/or time are provided via the *Start* and *End* inputs.

# ABB i-bus® KNX Parameters

## Numeric Converter (N-CONV)

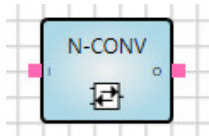

The converter allows you to link different data point types and convert them.

The following data types can be converted:

Data type	KNX data type
1 byte unsigned	5.xxx
1 byte signed	6.xxx
2 bytes unsigned	7.xxx
2 bytes signed	8.xxx
2 byte floating point	9.xxx
4 bytes unsigned	12.xxx
4 bytes signed	13.xxx
4 byte floating point	14.xxx

### Inputs

No.	DPT	Abbr.	Name	Visible	Description
1	See above	I	Input	Always	
2	See above	F	Factor	Parametrizable	
3	See above	O	Offset	Parametrizable	

### Outputs

No.	DPT	Abbr.	Name	Visible	Description
1	See above	O	Output	Always	

### Parameters

Name	Value	Visible	Description
Factor	Single float	Always	Enables <i>Factor</i> input
Offset	Single float	Always	Enables <i>Offset</i> input

# ABB i-bus<sup>®</sup> KNX Parameters

## Calculation

- The output is calculated as  $\text{Input} * \text{Factor} + \text{Offset}$ .
- If the output result is greater than the data type concerned: the maximum for the data type is applied to the output.
- If the output result is less than the data type concerned: the minimum for the data type is applied to the output.

The N-CONV element can be used to divide a 2-byte unsigned value into an upper and lower byte.

- The lower value is calculated using  $\text{Factor} = 1$ .
- The unsigned upper 2-byte value is calculated using  $\text{Factor} = 0.00390625 (= 1/256)$ .
- The unsigned upper 4-byte value is calculated using  $\text{Factor} = 0.0000152587890625 (= 1/65536)$ .
- The conversion of a 1-byte unsigned value from a value range 0...255 into 0...100 is calculated using  $\text{Factor} = 0.00390625$ .

## Other

Inputs not connected are treated as if they did not exist.

# ABB i-bus<sup>®</sup> KNX Parameters

## RS Flip Flop (RS-FF)

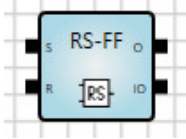

Stores input states and resets them on request.

### Inputs

No.	DPT	Abbr.	Name	Visible	Description
1	1 bit	S	Set	Always	A value of 1 sets the Flip Flop output to 1.
2	1 bit	R	Reset	Always	A value of 1 resets the Flip Flop output to 0 and disables it.

### Outputs

No.	DPT	Abbr.	Name	Visible	Description
1	1 bit	O	Output	Always	Flip Flop output status
2	1 bit	IO	Inverted output	Always	Inverted Flip Flop output status

### Parameters

Initial value:

Initial value of the input. Can only be used in combination with the *Set initial value after restart* parameter.

#### **i** Note

Selecting the checkbox sets the initial value to 1, but only with 1-bit values. Clearing the checkbox (default) sets the initial value to 0.

Set initial value after restart:

The initial value is used after a restart.

#### **i** Note

After a restart, either the initial values are used or the input values are restored, or the system waits for a telegram to arrive. In the first two cases, the logic function is not recalculated.

# ABB i-bus<sup>®</sup> KNX Parameters

## Function

Use of Flip Flop e.g. as an alarm memory.

No output value is actively set on the output.

Any initial values set can trigger an output change when the inputs receive an incoming signal.

O	S	R	O new
0	0	0	0
0	0	1	0
0	1	0	<u>1</u>
0	1	1	0
1	0	0	1
1	0	1	<u>0</u>
1	1	0	1
1	1	1	<u>0</u>

### Note

As long as input R = 1, the output is always 0.

## Bus voltage failure, download and restart

The values are stored. The last output value is restored on restart.

# ABB i-bus<sup>®</sup> KNX Parameters

## Up Counter (UP COUNT)

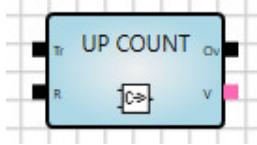

Counts upward from 0 to an adjustable threshold. Only counts value changes from 0 to 1.

### Inputs

No.	DPT	Abbr.	Name	Visible	Description
1	1 bit	Tr	Trigger	Always	Trigger input Value change from 0 to 1 increments the counter by 1
2	1 bit	R	Reset	Always	0 = counter counts 1 = resets the counter to 0 and disables it
3	8 bits or higher	Th	Threshold	Parametrizable	Counter threshold. Reaching this threshold triggers an overflow at the output.

### Outputs

No.	DPT	Abbr.	Name	Visible	Description
1	8 bits or higher	V	Value	Always	Counter value, integer
2	1 bit	Ov	Overflow	Always	Counter threshold reached

### Parameters

Name	Value	Visible	Description
Threshold	Integer value. Same data type as the counter value	Always	Selecting the corresponding checkbox activates the <i>Threshold</i> input

# ABB i-bus<sup>®</sup> KNX

## Parameters

### Function

- The counter increments on a change in the value from 0 to 1 (rising edge).
- The counter counts upward from 0 to an adjustable threshold. If it reaches this threshold, the counter stops and the *Overflow* output receives a value 1 (true) on the next rising edge.
- *Reset* input:
  - Value 0: The counter runs upwards.
  - Value 1: Resets the counter to 0 and disables it. The output value is 0.
- *Threshold* input:
  - Defines the counter threshold.
  - Can only be entered if the Output value is connected.

### Bus voltage failure, download and restart

The counter value is saved. The output value is restored on restart. The output value is updated the first time the counter value changes after restart.

### Application examples

- Telegram counter: counts the number of telegrams received (usage of *Telegram received* used on the KNX input).
- Pulse counter for energy values: calculates the energy consumption.
- Event counter: an alarm is triggered if three events occur within one minute.

# ABB i-bus® KNX Parameters

## PID Controller (PID)

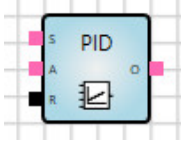

The PID-Controller calculates the output value from the difference between the *Setpoint* and the *Actual Value*. The control parameters are proportional coefficient, integral time and derivative time.

### Inputs

No.	DPT	Abbr.	Name	Visible	Description
1	Numerical, 1 byte or higher	S	Setpoint	Always	Target value of controller, e.g. target room temperature
2	Same as input 1	A	Actual value	Always	Current measured value
3	Numerical, 1 byte or higher	PC	Proportional coefficient	Parametrizable	Controller gain
4	Numerical, 1 byte or higher	IT	Integral time	Parametrizable	Integral time in [s]; typical value range: 60...900 s $C_i = 1/\text{Integral Time}$
5	Numerical, 1 byte or higher	DT	Derivative time	Parametrizable	Derivative time in [s]; typical value range: 1...10 s $C_d = \text{Derivative Time}$
6	1 bit	R	Reset	Always	Clears the integral element in the controller As long as R = 0 the integral value is set to 0.

### Outputs

No.	DPT	Abbr.	Name	Visible	Description
1	Numerical, 1 byte or higher	O	Output	Always	Control value, no unit Typically 1 byte unsigned (0...255)



# ABB i-bus<sup>®</sup> KNX Parameters

Room temperature control example:

The *Setpoint* and *Actual value* are two temperatures. The output value is the control value for a valve actuator.

## Parameters

Name	Value	Visible	Description
Controller type	- Proportional (P) - Integral (PI) - Derivative (PD) - PID	Always	
Proportional coefficient	Floating point number, default = 60	Always	
Integral time	Floating point number in [min], default = 90, 0 not permitted	If <i>Controller type</i> = PI or PID	Integral time in [s]; typical value range: 60...900 s
Integral time as input	- <u>Yes</u> - No	If <i>Controller type</i> = PI or PID	
Derivative time	Floating point number in [s], default = 1	If <i>Controller type</i> = PD or PID	Derivative time in [s]; typical value range: 1...10 s
Derivative time as input	- <u>Yes</u> - <u>No</u>	If <i>Controller type</i> = PD or PID	
Limit output value, anti-wind-up	- <u>Yes</u> - No	Always	Limits the output value to a range. If this range is exceeded, a limit is imposed on the integral element in the controller ("anti-wind-up")
Lower limit	Floating point number, default = 0	Always	
Upper limit	Floating point number, default = 255	Always	

## Description of parameters

Controller type:

Value	Description
P (Proportional)	Proportional controller. The integral and derivative coefficients are 0.
PI (Integral)	Proportional integral controller. The derivative coefficient is 0.
PD (Derivative)	Proportional derivative controller. The integral coefficient is 0.
PID	Proportional integral derivative controller

If the controller type is P (Proportional), the integral value and derivative value are always 0.

# ABB i-bus<sup>®</sup> KNX Parameters

## Function

Schematic diagram of controller:

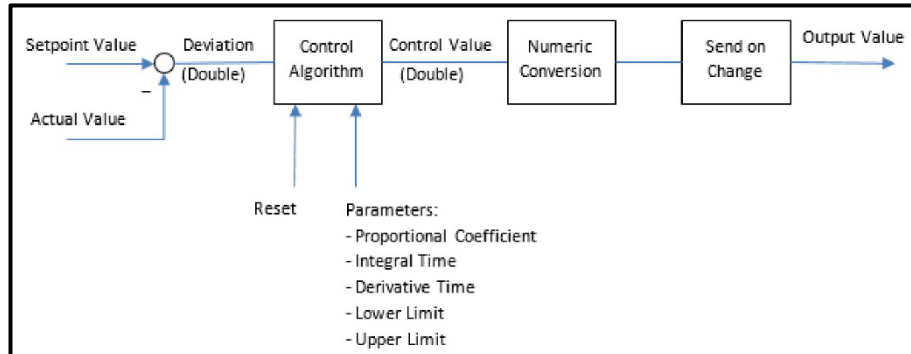

Algorithms:

- $ControlValue = ProportionalValue + IntegralValue + DerivativeValue$
- $ProportionalValue = Deviation \times ProportionalCoefficient$
- $IntegralValue = IntegralValue\ Old + Deviation \times CycleTime / IntegralTime$
- $DerivativeValue = (Deviation - Deviation\ Old) / CycleTime \times DerivativeTime$

The controller calculates a new output value in the cycle time for the logic calculation (see [Settings](#)) (usually every 200 ms). The output sends on value change.

If the ControlValue exceeds the *Upper limit* or *Lower limit* (see parameters), the values are limited accordingly and the IntegralValue is reduced.

If the Reset input = 1: the integral value is set to 0.

## Exceptions

For parameter inputs (Proportional coefficient, Integral time, Derivative time) not connected, the function element uses the value 0.

## Bus voltage failure, download and restart

The integral value is saved. The value is restored on restart.

# ABB i-bus<sup>®</sup> KNX Parameters

## Constant (CONST)

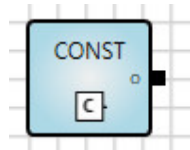

The constant can be used, for example, for the purposes of comparison with other input variables. The constant never triggers a recalculation.

### Outputs

No.	DPT	Abbr.	Name	Visible	Description
1	Any	O	Output	Always	

### Parameters

Name	Value	Visible	Description
Constant value	According to DPT	Always	For entering a constant value Selecting the checkbox sets the initial value to 1, but only with 1-bit values. Clearing the checkbox sets a value of 0.

# ABB i-bus® KNX Parameters

## Website Input (WEB IN)



Generates an input value on in the web browser (web user interface).

On the use of this element, a corresponding entry for value input is added to the WebUI. Values entered are forwarded to the logic.

## Outputs

No.	DPT	Abbr.	Name	Visible	Description
1	Any	I	In	Always	Sends the value entered on the WebUI.

## Parameters

Name	Value	Visible	Description
Min value	According to DPT	Always	Minimum value that can be entered on the WebUI.
Max value	According to DPT	Always	Maximum value that can be entered on the WebUI.
Index	Integer	Always	Defines the order in which the input values are displayed on the WebUI. Small values displayed at the top.

## Function

The element name is applied as the description text on the web user interface.

# ABB i-bus<sup>®</sup> KNX Parameters

## Website Output (WEB OUT)

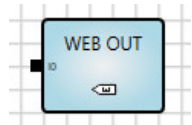

Generates an output value on the web browser (web user interface). This value is read-only.

### Inputs

No.	DPT	Abbr.	Name	Visible	Description
1	Any	IO	Out	Always	Displayed value

### Parameters

Name	Value	Visible	Description
Index	Integer	Always	Defines the order in which the output values are displayed on the WebUI. Small values displayed at the top.

### Function

The element name is applied as the description text on the web user interface.

# ABB i-bus<sup>®</sup> KNX Parameters

## Function Block Input (FB IN)

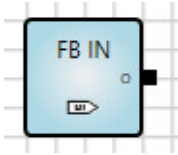

Input for a user-defined function block. If you wish to use the same logic several times, you can combine and save it in a function block. In this case the function block input is used instead of an input socket.

## Outputs

No.	DPT	Abbr.	Name	Visible	Description
1	Any	O	Output	Always	

## Parameters

Name	Value	Visible	Description
Short description	According to DPT	Always	Default: I
Full description	According to DPT	Always	Default: Input
Index	According to DPT	Always	Default: 0

# ABB i-bus<sup>®</sup> KNX Parameters

## Function Block Output (FB OUT)

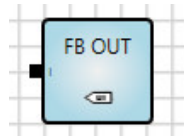

Output for a user-defined function block. If you wish to use the same logic several times, you can combine and save it in a function block. In this case the function block output is used instead of an output socket.

### Outputs

No.	DPT	Abbr.	Name	Visible	Description
1	Any	I	Input	Always	

### Parameters

Name	Value	Visible	Description
Short description	According to DPT	Always	Default: 0
Full description	According to DPT	Always	Default: Output
Index	According to DPT	Always	Default: 0

# ABB i-bus<sup>®</sup> KNX Parameters

## Composite function blocks

If you wish to use the same logic function several times, you can combine and save it in a composite function block.

How to create a composite function block:

1. Create your logic using "normal" input sockets and output sockets and check the function of the logic using the simulation.
2. Copy the logic and replace the input sockets and output sockets with the function blocks FB IN and FB OUT of the same data type.
3. Enter the following parameters for function blocks FB IN and FB OUT:
  - Short description:  
One or more letters that are displayed on the input and output of the function block.
  - Full description:  
Name of the function block, can be seen on moving over it with the mouse.
  - Index:  
The number of the input/output; this must be unique.

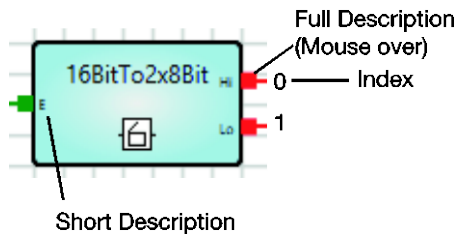



# ABB i-bus<sup>®</sup> KNX Parameters

4. Select the entire logic and choose *Edit > Create composite block*.
5. The following dialog window appears:

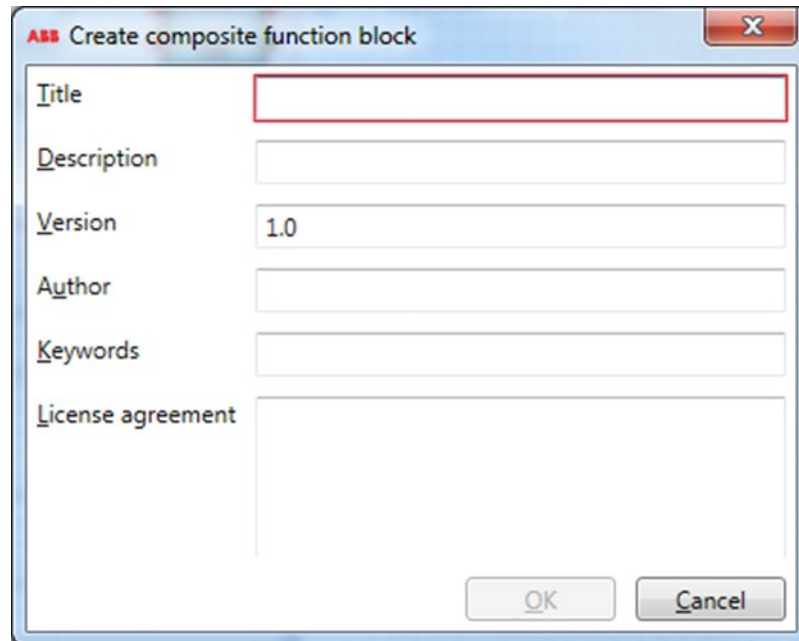

The dialog window is titled "ABB Create composite function block". It features a title bar with the ABB logo and a close button. The main area contains the following fields:

- Title**: A text input field with a red border.
- Description**: A text input field.
- Version**: A text input field containing the value "1.0".
- Author**: A text input field.
- Keywords**: A text input field.
- License agreement**: A larger text input area.

At the bottom right, there are two buttons: "OK" and "Cancel".

Enter the data saved with the function block. The title must be unique.

6. Click OK.

The composite function block is now stored and is available in *Own function blocks* on the left in the Element Selector window.

# ABB i-bus<sup>®</sup> KNX Parameters

Exporting composite function blocks:

1. Select the composite function block in *Own function blocks*.



2. Select *Export function block*.
3. The following dialog window appears:

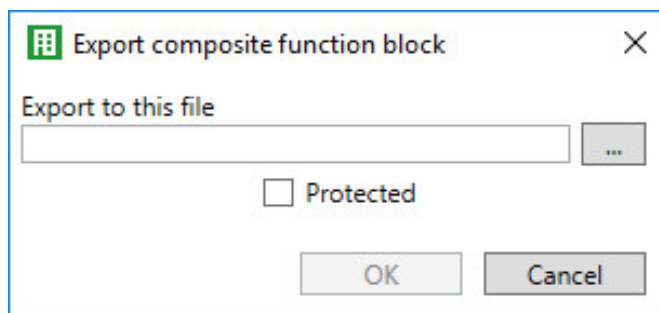

Enter a name for the destination file.

Enabling the *Protected* option encrypts the destination file.

Importing composite function blocks:

Select *File > Import composite function block*.

## **Note**

Inverting the outputs of composite function blocks currently has no effect.  
At the moment, composite function blocks cannot be linked to internal markers.

# ABB i-bus<sup>®</sup> KNX Parameters

## Comment

**ABC**

The Comment element can be saved to explain the logical operator.

You can adjust the angle of rotation, width and height by dragging and dropping using the left mouse button, or in the Properties window.

## Rectangle



The Rectangle element can be used to improve clarity, for example by framing a logical operator.

You can adjust the angle of rotation, width and height by dragging and dropping using the left mouse button, or in the Properties window.

## Line



The Line element can be used to improve clarity.

You can adjust the angle of rotation, width and height by dragging and dropping using the left mouse button, or in the Properties window.

# ABB i-bus<sup>®</sup> KNX Parameters

## 7.4.3

### Sockets



The data from other ASMs are read into your ASM using input sockets and used in the logic in your ASM. The results of the logic are output to other ASMs via output sockets.

Create sockets by adding function elements of type SOCKET IN or SOCKET OUT. For each function element of this type added, the corresponding socket appears with the name set and the data point type.

Overview of the ASM sockets for linking to other modules:

#### Input sockets

Object name	Data type
<b>Socket IN</b>	<b>Configuration-dependent</b>
An input socket appears if you select a Socket IN function element in the configuration. The data point type is dependent on the function selected.	
Signal value:	Configuration-dependent

#### Output sockets

Object name	Data type
<b>Socket OUT</b>	<b>Configuration-dependent</b>
An output socket appears if you select a Socket OUT function element in the configuration. The data point type is dependent on the function selected.	
Signal value:	Configuration-dependent

## 7.4.4

### Group objects

No objects available

## 7.4.5

### BACnet objects

No objects available

# ABB i-bus<sup>®</sup> KNX Parameters

## 7.4.6

### Web user interface

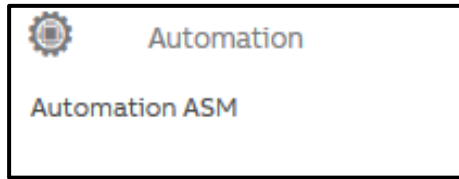

Open the detailed view of the ASM by clicking the ASM's tile.

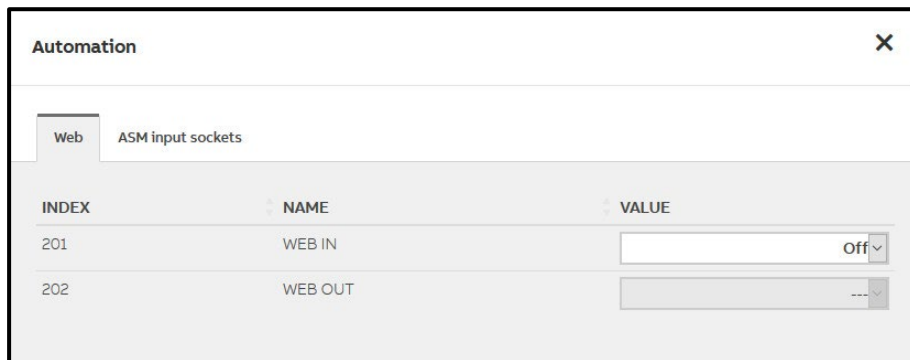

A field is displayed on the web user interface for each function element of type WEB IN and WEB OUT used in your logic. All users except the "Viewer" have access and can enter data.

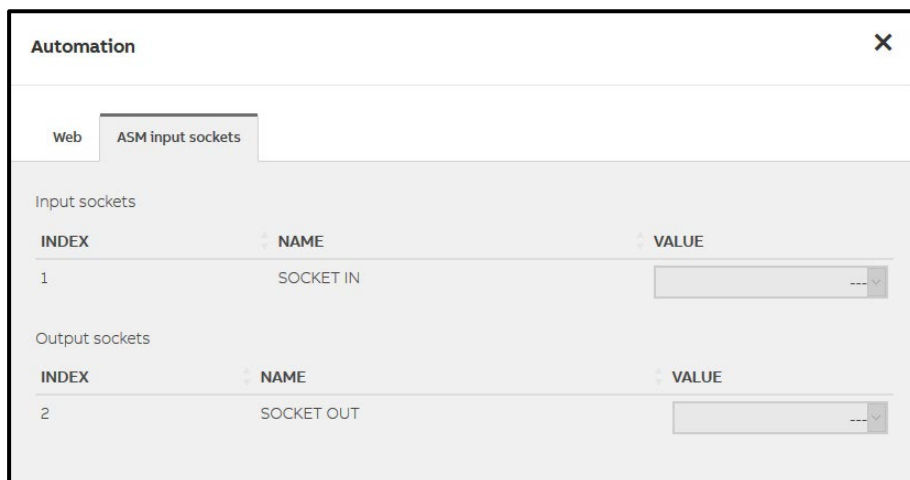

In addition, the states of all input sockets and output sockets are displayed for information.

# ABB i-bus<sup>®</sup> KNX Parameters

## 7.5 Value ASM

### 7.5.1 General

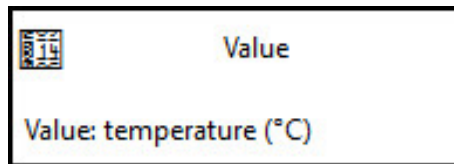

This application-specific automation module (ASM) can exchange any data between the various interfaces on the application controller (KNX, BACnet, web user interface and ASM sockets).

You can select predefined templates in the ASM settings for the most frequent situations.

Only one value can be transferred per module. The data point type used can be selected as required.

### 7.5.2 Settings

General	
Name	Value
Description	
Reinstall	<input type="checkbox"/>
Interfaces	
Template	KNX to WebUI ▼
ASM socket	Output ▼
WebUI	Display ▼
KNX	Input from KNX ▼
BACnet	None ▼
Main data point type	9.xxx [2-byte float value] ▼
Data point type	9.001 [temperature (°C)] ▼
Use value after restart	Last value ▼
Read value at startup	<input type="checkbox"/>
Initial values	
Initial value	<input type="text" value="0"/> °C

#### General

You will find descriptions of the global settings (Name, Description, Reinstall, BACnet, WebUI) in [chapter 7.3, Global ASM settings](#).

# ABB i-bus<sup>®</sup> KNX Parameters

## **Interfaces**

### **Template**

Options: [KNX to WebUI](#)  
[KNX to BACnet](#)  
[KNX to ASM output socket](#)  
[WebUI to KNX](#)  
[WebUI to KNX with update](#)  
[BACnet to KNX](#)  
[BACnet to KNX with update](#)  
[ASM input socket to KNX](#)  
[Freely configurable](#)

You can select predefined templates for the most frequent situations. Then the following interface parameters within the ASM are set automatically. These interface parameters are visible, but cannot then be changed.

Alternatively, you can select all interface parameters as required by selecting the *Freely configurable* option. In this way it is possible, for example, to set up bidirectional data exchange between several interfaces.

You will find the descriptions of the individual templates in the following sections:

[KNX to WebUI](#)

[KNX to BACnet](#)

[KNX to ASM output socket](#)

[WebUI to KNX](#)

[WebUI to KNX with update](#)

[BACnet to KNX](#)

[BACnet to KNX with update](#)

[ASM input socket to KNX](#)

[Freely configurable](#)

# ABB i-bus<sup>®</sup> KNX

## Parameters

### *KNX to WebUI*

The value received in the group object is displayed on the web user interface using this template. This value is also output on the ASM output socket for linking to other modules.

The settings for the ASM socket, web user interface, KNX and BACnet are set automatically as follows:

ASM socket:	Output
WebUI:	Display
KNX:	Input from KNX
BACnet:	None

### **Main data point type**

#### **Data point type**

Definition of the data point type that is transferred between the interfaces.

You will find further information on the data point types in [chapter 4.7 Data point types](#).

### **Use value after restart**

Options:        Last value  
                  Initial value

This parameter defines which value is output on the web user interface and the ASM socket after starting the application controller until a new value is received in the group object.

- *Last value*: The last value before device start is saved and reused. The value parameterized further down in *Initial value* is used after the first download of the module to the application controller.
- *Initial value*: The value described further down in *Initial value* is used.



# ABB i-bus<sup>®</sup> KNX Parameters

## **Read value at startup**

Options:            No (checkbox cleared)  
                      Yes (checkbox selected)

- *No (checkbox cleared)*: The module behaves passively after the start and waits until it receives a new value in the group object.
- *Yes (checkbox selected)*: After a start, the module actively requests the current value via the group object using a KNX Value Read telegram.

## **Initial values**

### **Initial value**

This parameter defines the value that is output after downloading the module. This value is output on the web user interface and the ASM socket until a new value in the group object overwrites it.

The value range is dependent on the data point type set.

# ABB i-bus<sup>®</sup> KNX

## Parameters

### *KNX to BACnet*

The value received in the group object is output in the BACnet object using this template. The value cannot be changed by BACnet. This value is also output on the web user interface and on the ASM output socket for linking to other modules.

The settings for the ASM socket, web user interface, KNX and BACnet are set automatically as follows:

ASM socket:	Output
WebUI:	Display
KNX:	Input from KNX
BACnet:	Readable by BACnet

### **Main data point type**

#### **Data point type**

Definition of the data point type that is transferred between the interfaces.

You will find further information on the data point types in [chapter 4.7 Data point types](#).

### **Use value after restart**

Options:      Last value  
                 Initial value

This parameter defines which value is output in the BACnet object, on the web user interface and the ASM socket after starting the application controller until a new value is received in the group object.

- *Last value*: The last value before device start is saved and reused. The value parameterized further down in *Initial value* is used after the first download of the module to the application controller.
- *Initial value*: The value described further down in *Initial value* is used.

# ABB i-bus<sup>®</sup> KNX Parameters

## **Read value at startup**

Options:            No (checkbox cleared)  
                      Yes (checkbox selected)

- *No (checkbox cleared)*: The module behaves passively after the start and waits until it receives a new value in the group object.
- *Yes (checkbox selected)*: After a start, the module actively requests the current value via the group object using a KNX Value Read telegram.

## **Initial values**

### **Initial value**

This parameter defines the value that is output after downloading the module. This value is output on the web user interface and the ASM socket until a new value in the group object overwrites it.

The value range is dependent on the data point type set.

# ABB i-bus® KNX

## Parameters

### *KNX to ASM output socket*

Using this template, the value received in the group object is output on the ASM output socket for linking to other modules. This value is also output on the web user interface.

The settings for the ASM socket, web user interface, KNX and BACnet are set automatically as follows:

ASM socket:	Output
WebUI:	Display
KNX:	Input from KNX
BACnet:	None

### **Main data point type**

#### **Data point type**

Definition of the data point type that is transferred between the interfaces.

You will find further information on the data point types in [chapter 4.7 Data point types](#).

### **Use value after restart**

Options:        Last value  
                  Initial value

This parameter defines which value is output on the web user interface and the ASM socket after starting the application controller until a new value is received in the group object.

- *Last value*: The last value before device start is saved and reused. The value parameterized further down in *Initial value* is used after the first download of the module to the application controller.
- *Initial value*: The value described further down in *Initial value* is used.

# ABB i-bus<sup>®</sup> KNX Parameters

## **Read value at startup**

Options:            No (checkbox cleared)  
                      Yes (checkbox selected)

- *No (checkbox cleared)*: The module behaves passively after the start and waits until it receives a new value in the group object.
- *Yes (checkbox selected)*: After a start, the module actively requests the current value via the group object using a KNX Value Read telegram.

## **Initial values**

### **Initial value**

This parameter defines the value that is output after downloading the module. This value is output on the web user interface and the ASM socket until a new value in the group object overwrites it.

The value range is dependent on the data point type set.

# ABB i-bus<sup>®</sup> KNX

## Parameters

### *WebUI to KNX*

A value entered on the web user interface is sent by the group object using this template. The value displayed on the web user interface cannot be changed via KNX. This value is also output on the ASM output socket for linking to other modules.

The settings for the ASM socket, web user interface, KNX and BACnet are set automatically as follows:

ASM socket:	Output
WebUI:	Display + Set
KNX:	Output to KNX
BACnet:	None

### **Main data point type**

#### **Data point type**

Definition of the data point type that is transferred between the interfaces.

You will find further information on the data point types in [chapter 4.7 Data point types](#).

### **Use value after restart**

Options:      Last value  
                 Initial value

This parameter defines which value is output in the group object after starting the application controller until a new value is entered on the web user interface.

- *Last value*: The last value before device start is saved and reused. The value parameterized further down in *Initial value* is used after the first download of the module to the application controller.
- *Initial value*: The value described further down in *Initial value* is used.

# ABB i-bus<sup>®</sup> KNX Parameters

## Send value to KNX by a change of

Options: 0...1...670760 °C  
(Value range dependent on the data point type selected)

This parameter changes the send behavior. The value is only sent on the KNX bus if the new value differs from the last value sent by the difference set. The value "0" means that this function is not active and any value change on the web user interface is sent on the bus. This function affects only the output on the KNX bus. The last value set on the web user interface is always output on the ASM output socket.

## Send cyclically values to KNX

Options: No (checkbox cleared)  
Yes (checkbox selected)

This parameter specifies whether the value is to be sent cyclically on the KNX bus.

- *No (checkbox cleared)*: The value is only sent on the KNX bus after a change.
- *Yes (checkbox selected)*: The value is sent on the KNX bus after every change and cyclically. The cycle time is set in the *Send cyclically values to KNX every* parameter below and is restarted each time on sending after a change.

Selection of Yes option:

Dependent parameter(s)

### Send cyclically values to KNX every

Options: 00:10:00...01:00:00...23:59:00 [hh:mm:ss]

## Initial values

### Initial value

This parameter defines the value that is output after downloading the module. This value is output on the web user interface and the ASM socket until a new value in the group object overwrites it.

The value range is dependent on the data point type set.

# ABB i-bus<sup>®</sup> KNX

## Parameters

### *WebUI to KNX with update*

A value entered on the web user interface is sent by the group object using this template. A value received from the KNX bus updates the value on the web user interface. This value is also output on the ASM output socket for linking to other modules.

The settings for the ASM socket, web user interface, KNX and BACnet are set automatically as follows:

ASM socket:	Output
WebUI:	Display + Set
KNX:	Input + output
BACnet:	None

### **Main data point type**

#### **Data point type**

Definition of the data point type that is transferred between the interfaces.

You will find further information on the data point types in [chapter 4.7 Data point types](#).

### **Use value after restart**

Options:        Last value  
                  Initial value

This parameter specifies which value is output on the ASM output socket after starting the application controller until a new value is received in the group object.

- *Last value*: The last value before device start is saved and reused. The value parameterized further down in *Initial value* is used after the first download of the module to the application controller.
- *Initial value*: The value described further down in *Initial value* is used.



# ABB i-bus<sup>®</sup> KNX Parameters

## Send value to KNX by a change of

Options: 0...1...670760 °C  
(Value range dependent on the data point type selected)

This parameter changes the send behavior. The value is only sent on the KNX bus if the new value differs from the last value sent by the difference set. The value "0" means that this function is not active and any value change is sent on the bus. This function affects only the output on the KNX bus. The last value is always output on the ASM output socket.

## Send cyclically values to KNX

Options: No (checkbox cleared)  
Yes (checkbox selected)

This parameter specifies whether the value is to be sent cyclically on the KNX bus.

- *No (checkbox cleared)*: The value is only sent on the KNX bus after a change.
- *Yes (checkbox selected)*: The value is sent on the KNX bus after every change and cyclically. The cycle time is set in the *Send cyclically values to KNX every* parameter below and is restarted each time on sending after a change.

Selection of Yes option:

Dependent parameter(s)

### Send cyclically values to KNX every

Options: 00:10:00...01:00:00...23:59:00 [hh:mm:ss]

# ABB i-bus<sup>®</sup> KNX

## Parameters

### Read value at startup

Options:            No (checkbox cleared)  
                      Yes (checkbox selected)

- *No (checkbox cleared)*: The module behaves passively after the start and waits until it receives a new value in the group object.
- *Yes (checkbox selected)*: After a start, the module actively requests the current value via the group object using a KNX Value Read telegram.

### Initial values

#### Initial value

This parameter defines the value that is output after downloading the module. This value is output on the web user interface and the ASM socket until a new value in the group object overwrites it.

The value range is dependent on the data point type set.

# ABB i-bus<sup>®</sup> KNX Parameters

## *BACnet to KNX*

A value received via the BACnet object is sent by the group object using this template. A value received from the KNX bus is not transmitted back to the BACnet object. The value is also output on the web user interface and on the ASM output socket for linking to other modules.

The settings for the ASM socket, web user interface, KNX and BACnet are set automatically as follows:

ASM socket:	Output
WebUI:	Display
KNX:	Output to KNX
BACnet:	Read + writable by BACnet

## **Main data point type**

### **Data point type**

Definition of the data point type that is transferred between the interfaces.

You will find further information on the data point types in [chapter 4.7 Data point types](#).

## **Use value after restart**

Options:      Last value  
                 Initial value

This parameter defines which value is output in the group object and the ASM output socket after starting the application controller until a new value is entered on the web user interface.

- *Last value*: The last value before device start is saved and reused. The value parameterized further down in *Initial value* is used after the first download of the module to the application controller.
- *Initial value*: The value described further down in *Initial value* is used.

# ABB i-bus<sup>®</sup> KNX Parameters

## Send value to KNX by a change of

Options: 0...1...670760 °C  
(Value range dependent on the data point type selected)

This parameter changes the send behavior. The value is only sent on the KNX bus if the new value differs from the last value sent by the difference set. The value "0" means that this function is not active and any value change is sent on the bus. This function affects only the output on the KNX bus. The last value is always output on the ASM output socket.

## Send cyclically values to KNX

Options: No (checkbox cleared)  
Yes (checkbox selected)

This parameter specifies whether the value is to be sent cyclically on the KNX bus.

- *No (checkbox cleared)*: The value is only sent on the KNX bus after a change.
- *Yes (checkbox selected)*: The value is sent on the KNX bus after every change and cyclically. The cycle time is set in the *Send cyclically values to KNX every* parameter below and is restarted each time on sending after a change.

Selection of Yes option:

Dependent parameter(s)

### Send cyclically values to KNX every

Options: 00:10:00...01:00:00...23:59:00 [hh:mm:ss]

## Initial values

### Initial value

This parameter defines the value that is output after downloading the module. This value is output on the web user interface and the ASM socket until a new value in the group object overwrites it.

The value range is dependent on the data point type set.

# ABB i-bus<sup>®</sup> KNX Parameters

## *BACnet to KNX with update*

A value received via the BACnet object is sent by the group object using this template. A value received from the KNX bus is transmitted back to the BACnet object. The value is also output on the web user interface and on the ASM output socket for linking to other modules.

The settings for the ASM socket, web user interface, KNX and BACnet are set automatically as follows:

ASM socket:	Output
WebUI:	Display
KNX:	Input + output
BACnet:	Read + writable by BACnet

## **Main data point type**

### **Data point type**

Definition of the data point type that is transferred between the interfaces.

You will find further information on the data point types in [chapter 4.7 Data point types](#).

## **Use value after restart**

Options:        Last value  
                  Initial value

This parameter defines which value is output in the group object and on the ASM output socket after starting the application controller until a new value is received in the group object.

- *Last value*: The last value before device start is saved and reused. The value parameterized further down in *Initial value* is used after the first download of the module to the application controller.
- *Initial value*: The value described further down in *Initial value* is used.

# ABB i-bus<sup>®</sup> KNX Parameters

## Send value to KNX by a change of

Options: 0...1...670760 °C  
(Value range dependent on the data point type selected)

This parameter changes the send behavior. The value is only sent on the KNX bus if the new value differs from the last value sent by the difference set. The value "0" means that this function is not active and any value change is sent on the bus. This function affects only the output on the KNX bus. The last value is always output on the ASM output socket.

## Send cyclically values to KNX

Options: No (checkbox cleared)  
Yes (checkbox selected)

This parameter specifies whether the value is to be sent cyclically on the KNX bus.

- *No (checkbox cleared)*: The value is only sent on the KNX bus after a change.
- *Yes (checkbox selected)*: The value is sent on the KNX bus after every change and cyclically. The cycle time is set in the *Send cyclically values to KNX every* parameter below and is restarted each time on sending after a change.

Selection of Yes option:

Dependent parameter(s)

### Send cyclically values to KNX every

Options: 00:10:00...01:00:00...23:59:00 [hh:mm:ss]

# ABB i-bus<sup>®</sup> KNX Parameters

## **Read value at startup**

Options:            No (checkbox cleared)  
                      Yes (checkbox selected)

- *No (checkbox cleared)*: The module behaves passively after the start and waits until it receives a new value in the group object.
- *Yes (checkbox selected)*: After a start, the module actively requests the current value via the group object using a KNX Value Read telegram.

## **Initial values**

### **Initial value**

This parameter defines the value that is output after downloading the module. This value is output on the web user interface and the ASM socket until a new value in the group object overwrites it.

The value range is dependent on the data point type set.

# ABB i-bus<sup>®</sup> KNX

## Parameters

### *ASM input socket to KNX*

The value received on the ASM input socket is sent by the group object using this template. A value from the KNX bus does not update this value. The value is also output on the web user interface.

The settings for the ASM socket, web user interface, KNX and BACnet are set automatically as follows:

ASM socket:	Input
WebUI:	Display
KNX:	Output to KNX
BACnet:	None

### **Aggregate function**

Options:	<u>None</u>
	Max
	Min
	Avg
	Or
	And

Using the Aggregate function it is possible to connect several output sockets to one input socket at the same time. As a result there are several different signals on the input socket. This setting specifies the related calculation function necessary

This function is shown graphically as appropriate on the input socket in the Linking view.

Depending on the selection, the data point types (DPT) available may be restricted. See following parameters.



# ABB i-bus<sup>®</sup> KNX Parameters

- *None*: No Aggregate function. Only one output socket can be connected to the ASM input socket.
- *Max.*: The highest value currently present on the input socket is used.



- *Min.*: The lowest value currently present on the input socket is used.



- *Avg*: The average of all values currently present on the input socket is calculated and used.



- *Or*: The input values are combined using a logical OR operator.

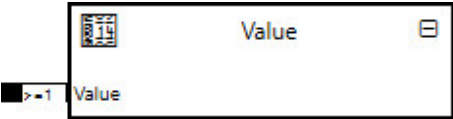

Value 1	Value 2	Value used
0	0	0
1	0	1
0	1	1
1	1	1

# ABB i-bus® KNX Parameters

- *And*: The input values are combined using a logical AND operator.



Value 1	Value 2	Value used
0	0	0
1	0	0
0	1	0
1	1	1

## Main data point type

### Data point type

Definition of the data point type that is transferred between the interfaces.

You will find further information on the data point types in [chapter 4.7 Data point types](#).

The selection available may be restricted depending on the parameters above.

# ABB i-bus<sup>®</sup> KNX Parameters

Data point types available for the *Max*, *Min* and *Avg* options:

- 5.xxx [8-bit unsigned]
  - 5.\*
  - 5.001 [percentage (0..100%)]
  - 5.003 [angle (degrees)]
  - 5.004 [percentage (0..255)]
  - 5.005 [ratio (0..255)]
  - 5.010 [counter pulses (0..255)]
- 9.xxx [2-byte floating point value]
  - 9.\*
  - 9.001 [temperature (°C)]
  - 9.002 [temperature difference (K)]
  - 9.003 [kelvin/hour (K/h)]
  - 9.004 [lux (Lux)]
  - 9.005 [speed (m/s)]
  - 9.006 [pressure (Pa)]
  - 9.007 [humidity (%)]
  - 9.008 [parts/million (ppm)]
  - 9.010 [time (s)]
  - 9.011 [time (ms)]
  - 9.020 [voltage (mV)]
  - 9.021 [current (mA)]
  - 9.022 [power density (W/m<sup>2</sup>)]
  - 9.023 [kelvin/percent (K/%)]
  - 9.024 [power (kW)]
  - 9.025 [volume flow (l/h)]
  - 9.026 [rain amount (l/h)]
  - 9.027 [temperature (°F)]
  - 9.028 [wind speed (km/h)]

# ABB i-bus<sup>®</sup> KNX

## Parameters

Data point types available for the *OR* and *AND* options:

- 1.xxx [1-bit]
  - 1.\*
  - 1.001 [switch]
  - 1.002 [boolean]
  - 1.003 [enable]
  - 1.004 [rise]
  - 1.005 [alarm]
  - 1.006 [binary value]
  - 1.007 [step]
  - 1.008 [up/down]
  - 1.009 [open/close]
  - 1.010 [start/stop]
  - 1.011 [status]
  - 1.012 [inversion]
  - 1.013 [dimming send type]
  - 1.014 [input type]
  - 1.015 [reset]
  - 1.016 [confirm]
  - 1.017 [tripping device]
  - 1.018 [layout]
  - 1.019 [window/door]
  - 1.021 [logic functions]
  - 1.022 [scene]
  - 1.023 [shutter/blind mode]
  - 1.100 [heat/cool]

# ABB i-bus<sup>®</sup> KNX Parameters

## Use value after restart

Options:        Last value  
                  Initial value

This parameter specifies which value is output in the group object and on the web user interface after starting the application controller until a new value is received on the ASM input socket.

- *Last value*: The last value before device start is saved and reused. The value parameterized further down in *Initial value* is used after the first download of the module to the application controller.
- *Initial value*: The value described further down in *Initial value* is used.

## Send value to KNX by a change of

Options:        0...1...670760 °C  
                  (Value range dependent on the data point type selected)

This parameter changes the send behavior. The value is only sent on the KNX bus if the new value differs from the last value sent by the difference set. The value "0" means that this function is not active and any value change is sent on the bus. This function affects only the output on the KNX bus. The last value is always output on the ASM output socket.

## Send cyclically values to KNX

Options:        No (checkbox cleared)  
                  Yes (checkbox selected)

This parameter specifies whether the value is to be sent cyclically on the KNX bus.

- *No (checkbox cleared)*: The value is only sent on the KNX bus after a change.
- *Yes (checkbox selected)*: The value is sent on the KNX bus after every change and cyclically. The cycle time is set in the *Send cyclically values to KNX every* parameter below and is restarted each time on sending after a change.

Selection of Yes option:

Dependent parameter(s)

### Send cyclically values to KNX every

Options:        00:10:00...01:00:00...23:59:00 [hh:mm:ss]

# ABB i-bus<sup>®</sup> KNX

## Parameters

### **Initial values**

#### **Initial value**

This parameter defines the value that is output after downloading the module. This value is output on the web user interface and the ASM socket until a new value in the group object overwrites it.

The value range is dependent on the data point type set.

# ABB i-bus<sup>®</sup> KNX Parameters

## *Freely configurable*

The interfaces can be parameterized as required using this template.

It is possible to parameterize several interfaces (KNX, BACnet, web user interface) as an input at the same time. Independent of the interface, the last value received then applies for all interfaces.

### **ASM socket**

Options:            Input  
                      Output

This parameter specifies whether the ASM has an input socket or an output socket.

- *Input*: The ASM has an input socket. As a consequence the options that can be selected for the other interfaces are restricted to *Output* and *Display*.

For system-related reasons, the values from other ASMs are continuously present on the input socket, while input values from KNX, BACnet and the web user interface are transmitted dependent on the event. As such if several interfaces are active at the same time, the last value cannot be identified unambiguously. For this reason the possible selections for the following interface parameters are restricted.

- *Output*: The ASM has an output socket. The options that can be selected for the other interfaces are not restricted.

Selection of *Input* option:

Dependent parameter(s)

#### **Aggregate function**

Options:            None  
                      Max  
                      Min  
                      Avg  
                      Or  
                      And

# ABB i-bus® KNX Parameters

Using the Aggregate function it is possible to connect several output sockets to one input socket at the same time. As a result there are several different signals on the input socket. This setting specifies the related calculation function necessary

This function is shown graphically as appropriate on the input socket in the Linking view.

Depending on the selection, the data point types (DPT) available may be restricted. See following parameters.

- *None*: No Aggregate function. Only one output socket can be connected to the ASM input socket.
- *Max.*: The highest value currently present on the input socket is used.



- *Min.*: The lowest value currently present on the input socket is used.



- *Avg*: The average of all values currently present on the input socket is calculated and used.





# ABB i-bus<sup>®</sup> KNX Parameters

- Or: The input values are combined using a logical OR operator.



Value 1	Value 2	Value used
0	0	0
1	0	1
0	1	1
1	1	1

- And: The input values are combined using a logical AND operator.



Value 1	Value 2	Value used
0	0	0
1	0	0
0	1	0
1	1	1

## WebUI

Options: Display  
 Display + Set  
 (not available if the *Input* option has been selected for *ASM socket*)

Possible settings for the web user interface.

- *Display*: The value from the other interfaces is displayed on the web user interface and cannot be changed.
- *Display + Set*: The value is displayed on the web user interface and can be changed.

# ABB i-bus<sup>®</sup> KNX

## Parameters

### KNX

Options:            Input from KNX  
                         (not available if the *Input* option has been selected for *ASM socket*)  
                         Input + output  
                         (not available if the *Input* option has been selected for *ASM socket*)  
                         Output to KNX  
                         None

This parameter specifies how the value on KNX is received or sent.

- *Input from KNX*: The ASM has an input group object. Updated values from other interfaces, e.g. web user interface, are not output in the group object.
- *Input + output*: The ASM has a combined group object as input and output. Updated values from other interfaces, e.g. web user interface, are output in the group object.
- *Output to KNX*: The ASM has an output group object. The values from the other interfaces, e.g. web user interface, are output in the group object.
- *None*: The ASM does not have a group object.

Selection of *Input + output* or *Output to KNX* option:

Dependent parameter(s)

#### **Send value to KNX by a change of**

Options:            0...1...670760 °C  
                         (Value range dependent on the data point type selected)

This parameter changes the send behavior. The value is only sent on the KNX bus if the new value differs from the last value sent by the difference set. The value "0" means that this function is not active and any value change is sent on the bus. This function affects only the output on the KNX bus. The last value is always output on the ASM output socket.

# ABB i-bus<sup>®</sup> KNX Parameters

## Send cyclically values to KNX

Options:           No (checkbox cleared)  
                      Yes (checkbox selected)

This parameter specifies whether the value is to be sent cyclically on the KNX bus.

- *No (checkbox cleared)*: The value is only sent on the KNX bus after a change.
- *Yes (checkbox selected)*: The value is sent on the KNX bus after every change and cyclically. The cycle time is set in the *Send cyclically values to KNX every* parameter below and is restarted each time on sending after a change.

Selection of Yes option:

Dependent parameter(s)

### Send cyclically values to KNX every

Options:           00:10:00...01:00:00...23:59:00 [hh:mm:ss]

Selection of *Input* or *Input + output* option:

Dependent parameter(s)

### Read value at startup

Options:           No (checkbox cleared)  
                      Yes (checkbox selected)

- *No (checkbox cleared)*: The value is only sent on the KNX bus after a change.
- *Yes (checkbox selected)*: The value is sent on the KNX bus after every change and cyclically. The cycle time is set in the *Send cyclically values to KNX every* parameter below and is restarted each time on sending after a change.

# ABB i-bus<sup>®</sup> KNX Parameters

## **BACnet**

Options:           Readable by BACnet  
                      Read + writable by BACnet  
                      (not available if the *Input* option has been selected for *ASM socket*)  
                      None

This parameter specifies how the value on BACnet is received or sent.

- *Readable by BACnet*: The value from the other interfaces is output in the BACnet object and cannot be changed via BACnet.
- *Read + writable by BACnet*: The value can be read via BACnet and can also be changed via BACnet.
- *None*: The ASM does not have a BACnet interface.

## **Main data point type**

### **Data point type**

Definition of the data point type that is transferred between the interfaces.

You will find further information on the data point types in [chapter 4.7 Data point types](#).

The selection available may be restricted depending on the parameters above.

# ABB i-bus<sup>®</sup> KNX Parameters

Data point types available for the *Max*, *Min* and *Avg* options:

- 5.xxx [8-bit unsigned]
  - 5.\*
  - 5.001 [percentage (0..100%)]
  - 5.003 [angle (degrees)]
  - 5.004 [percentage (0..255)]
  - 5.005 [ratio (0..255)]
  - 5.010 [counter pulses (0..255)]
- 9.xxx [2-byte floating point value]
  - 9.\*
  - 9.001 [temperature (°C)]
  - 9.002 [temperature difference (K)]
  - 9.003 [kelvin/hour (K/h)]
  - 9.004 [lux (Lux)]
  - 9.005 [speed (m/s)]
  - 9.006 [pressure (Pa)]
  - 9.007 [humidity (%)]
  - 9.008 [parts/million (ppm)]
  - 9.010 [time (s)]
  - 9.011 [time (ms)]
  - 9.020 [voltage (mV)]
  - 9.021 [current (mA)]
  - 9.022 [power density (W/m<sup>2</sup>)]
  - 9.023 [kelvin/percent (K/%)]
  - 9.024 [power (kW)]
  - 9.025 [volume flow (l/h)]
  - 9.026 [rain amount (l/h)]
  - 9.027 [temperature (°F)]
  - 9.028 [wind speed (km/h)]

# ABB i-bus® KNX

## Parameters

Data point types available for the *OR* and *AND* options:

- 1.xxx [1-bit]
  - 1.\*
  - 1.001 [switch]
  - 1.002 [boolean]
  - 1.003 [enable]
  - 1.004 [rise]
  - 1.005 [alarm]
  - 1.006 [binary value]
  - 1.007 [step]
  - 1.008 [up/down]
  - 1.009 [open/close]
  - 1.010 [start/stop]
  - 1.011 [status]
  - 1.012 [inversion]
  - 1.013 [dimming send type]
  - 1.014 [input type]
  - 1.015 [reset]
  - 1.016 [confirm]
  - 1.017 [tripping device]
  - 1.018 [layout]
  - 1.019 [window/door]
  - 1.021 [logic functions]
  - 1.022 [scene]
  - 1.023 [shutter/blind mode]
  - 1.100 [heat/cool]

# ABB i-bus<sup>®</sup> KNX

## Parameters

### **Use value after restart**

Options:        Last value  
                  Initial value

This parameter specifies which value is output in the group object and on the web user interface after starting the application controller until a new value is received on the ASM input socket.

- *Last value*: The last value before device start is saved and reused. The value parameterized further down in *Initial value* is used after the first download of the module to the application controller.
- *Initial value*: The value described further down in *Initial value* is used.

### **Initial values**

#### **Initial value**

This parameter defines the value that is output after downloading the module. This value is output on the web user interface and the ASM socket until a new value in the group object overwrites it.

The value range is dependent on the data point type set.

# ABB i-bus<sup>®</sup> KNX Parameters

## 7.5.3

### Sockets



The ASM has an input socket or an output socket depending on the template set in the parameters. The data point type is dependent on the configuration.

Overview of the ASM sockets for linking to other modules:

Type	Object name	Data type
Input	Value	Configuration-dependent
Output	Value	Configuration-dependent

#### **Input sockets**

Object name	Data type
<b>Value</b>	<b>Configuration-dependent</b>
<p>The module has an input socket if the <a href="#">ASM input socket to KNX</a> template or the <a href="#">Freely configurable</a> template is selected with the <i>ASM socket: Input</i> parameter.</p> <p>Input for outputting a value from another module on one of the interfaces activated.</p> <p>Signal value: Configuration-dependent</p>	

#### **Output sockets**

Object name	Data type
<b>Value</b>	<b>Configuration-dependent</b>
<p>The module has an output socket if the <a href="#">KNX to WebUI</a>, <a href="#">KNX to BACnet</a>, <a href="#">KNX to ASM output socket</a>, <a href="#">WebUI to KNX</a>, <a href="#">WebUI to KNX with update</a>, <a href="#">BACnet to KNX</a>, <a href="#">BACnet to KNX with update</a> template or the <a href="#">Freely configurable</a> template is selected with the <i>ASM socket: Output</i> parameter.</p> <p>The current value is output for the linking to other modules.</p> <p>Signal value: Configuration-dependent</p>	



# ABB i-bus<sup>®</sup> KNX Parameters

## 7.5.4

### Group objects

The ASM can only ever transmit/receive one value and therefore has only one group object. Depending on the template selected, this is an input, output or input/output.

The data point type is also dependent on the parameterization of the ASM.

Object function	Name (can be changed separately)	Data point type (DPT)	Length	Flags						
				C	R	W	T	U	I	
Input: Value	Value	Configuration-dependent	Configuration-dependent	x		x	x			
In-/Output: Value	Value	Configuration-dependent	Configuration-dependent	x	x	x	x			
Output: Value	Value	Configuration-dependent	Configuration-dependent	x		x	x			

Object function	Name (can be changed separately)	Data type	Flags
<b>Input: Value</b>	<b>Value</b>	<b>Configuration-dependent</b>	<b>C, W, T</b>
<p>The module has an input group object if the <a href="#">KNX to WebUI</a>, <a href="#">KNX to BACnet</a>, <a href="#">KNX to ASM output socket</a> template or the <a href="#">Freely configurable</a> template is selected with the <i>KNX: Input</i> parameter.</p> <p>Input for the KNX value for output on the parameterized interfaces.</p> <p>Telegram value: Configuration-dependent</p>			
<b>In-/Output: Value</b>	<b>Value</b>	<b>Configuration-dependent</b>	<b>C, R, W, T</b>
<p>The module has an input/output group object if the <a href="#">WebUI to KNX with update</a>, <a href="#">BACnet to KNX with update</a> template or the <a href="#">Freely configurable</a> template is selected with the <i>KNX: Input + output</i> parameter.</p> <p>Input for the KNX value for output on the parameterized interfaces. Updated values from other interfaces are output again via this group object.</p> <p>Telegram value: Configuration-dependent</p>			
<b>Output: Value</b>	<b>Value</b>	<b>Configuration-dependent</b>	<b>C, R, T</b>
<p>The module has an output group object if the <a href="#">WebUI to KNX</a>, <a href="#">BACnet to KNX</a> template or the <a href="#">Freely configurable</a> template is selected with the <i>KNX: Output</i> parameter.</p> <p>The current value from the parameterized interfaces is output via this group object.</p> <p>Telegram value: Configuration-dependent</p>			

# ABB i-bus<sup>®</sup> KNX Parameters

## 7.5.5 BACnet objects

The ASM can only ever transmit/receive one value and therefore has only one BACnet object. Depending on the template selected, this is an input or output.

The data point type is also dependent on the parameterization of the ASM.

Type	Object name	Object type	Unit	COV send condition
Input	Value: Value	Configuration-dependent	Configuration-dependent	-
Output	Value: Value	Configuration-dependent	Configuration-dependent	1.0

### BACnet input objects

Object name	Object type	Unit	COV send condition
<b>Value: Value</b>	<b>Configuration-dependent</b>	<b>Configuration-dependent</b>	-
<p>The module has a BACnet input object if the <a href="#">KNX to BACnet</a> template or the <a href="#">Freely configurable</a> template is selected with the <i>BACnet: Readable by BACnet</i> parameter.</p> <p>Input for the BACnet value for output on the parameterized interfaces.</p> <p>Signal value: Configuration-dependent</p>			

### BACnet output objects

Object name	Object type	Unit	COV send condition
<b>Value: Value</b>	<b>Configuration-dependent</b>	<b>Configuration-dependent</b>	<b>1.0</b>
<p>The module has a BACnet output object if the <a href="#">BACnet to KNX</a>, <a href="#">BACnet to KNX with update</a> template or the <a href="#">Freely configurable</a> template is selected with the parameter <i>BACnet: Read + writable by BACnet</i>.</p> <p>The current value from the parameterized interfaces is output via this object on BACnet.</p> <p>Signal value: Configuration-dependent</p>			

# ABB i-bus<sup>®</sup> KNX Parameters

## 7.5.6

### WebUI

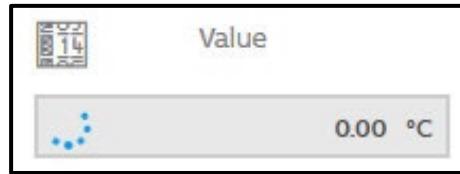

The current value is displayed on the web user interface for all configurations. With the following configurations, the value can also be changed on the web user interface:

- *WebUI to KNX* template
- *WebUI to KNX with update* template
- *Freely configurable* template, *WebUI :Display + Set* parameter

# ABB i-bus<sup>®</sup> KNX Parameters

## 7.6 Link ASM

### 7.6.1 General



This application-specific automation module (ASM) can open other websites, direct IP addresses or URLs from the web user interface. The module can also be used to save an e-mail address.

The module indication in ETS is static. The indication "http://..." in the tile does not change.

### 7.6.2 Settings



#### General

You will find descriptions of the global settings (Name, Description, Reinstall, BACnet, WebUI) in [chapter 7.3, Global ASM settings](#).

This module does not need a reinstall function and therefore does not have a corresponding option in the settings, at variance with the global settings described for modules.

# ABB i-bus<sup>®</sup> KNX Parameters

## **Interfaces**

### **URL**

Information on the destination address for the reference. It is possible to specify both IP addresses and also domains (e.g. <http://www.ABB.com/KNX>). The URL must always start with the information on the protocol. For example "http://" for web sites or "mailto:" for e-mail addresses. The specification of the protocol in compliance with the standards is validated and errors indicated with a red marking.

The protocols that can be used are dependent on the device used by the user and are not restricted by the application controller.

Destination addresses with up to 600 characters are supported.

### **7.6.3**

#### **Sockets**



The module does not have any ASM sockets and can therefore not be linked to other modules. No inputs or outputs are displayed.

### **7.6.4**

#### **Group objects**

No objects available

### **7.6.5**

#### **BACnet objects**

No objects available

# ABB i-bus<sup>®</sup> KNX Parameters

## 7.6.6

### WebUI

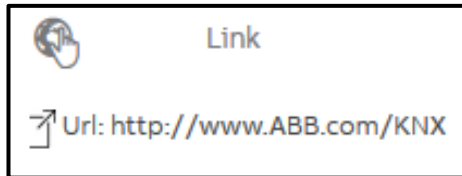

Click the ASM to open the destination of the link.

With long destination addresses, the end is truncated in the ASM tile. However it will still function correctly.

# ABB i-bus<sup>®</sup> KNX Parameters

## 7.7 Room ASM

### 7.7.1 General

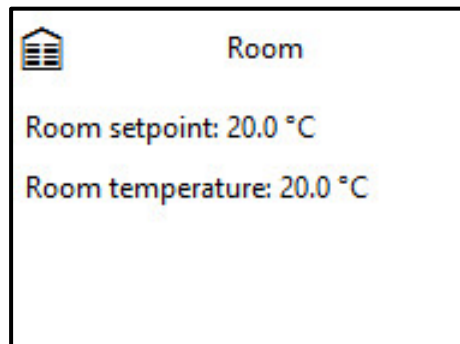

Using this application-specific automation module (ASM), all KNX HVAC automation devices in a room can be displayed and operated on the web user interface. The room display on the web user interface is generated automatically based on the ASM configuration.

This module also outputs the current states and values on ASM output sockets and in BACnet objects.

# ABB i-bus<sup>®</sup> KNX Parameters

7.7.2

## Settings

General	
Name	Room
Description	
Reinstall	<input type="checkbox"/>
Interfaces	
Room setpoint temperature	Display ▼
Controller On/Off	None ▼
Heating/cooling operating type	None ▼
Operating mode	None ▼
Window status	<input type="checkbox"/>
Presence detector	<input type="checkbox"/>
Rel. humidity	<input type="checkbox"/>
CO2 value	<input type="checkbox"/>
Fan coil unit	None ▼
Radiator	None ▼
Floor heating	None ▼
Cooling ceiling	None ▼
Split unit	<input type="checkbox"/>

### General

You will find descriptions of the global settings (Name, Description, Reinstall, BACnet, WebUI) in [chapter 7.3. Global ASM settings](#).



# ABB i-bus<sup>®</sup> KNX

## Parameters

### **Interfaces**

In the following parameters, activate the functions available in the KNX HVAC room automation devices. In this way the related group objects for linking to the KNX HVAC room automation objects are shown in the module. Furthermore, the web user interface for the module is generated and the ASM output sockets and BACnet objects are activated based on these settings.

### **Room setpoint temperature**

Options:            Display  
                      Display+set (slave) DPT 9.001/DPT 9.002  
                      Display+set (slave) DPT 6.010

This parameter specifies whether the room setpoint temperature from the room thermostat received via KNX is only to be displayed on the web user interface, or it can also be changed by the user. The current value is output on the ASM output socket and in a BACnet object.

- *Display*: The room setpoint temperature is only displayed on the web user interface and cannot be changed.
- *Display+set (slave) DPT 9.001/DPT 9.002*: The room setpoint temperature can be changed on the web user interface.  
This setting functions only with ABB and Busch-Jaeger devices with the new master/slave interface with group objects of type DPT 9.001 (absolute temperature) / DPT 9.002 (relative temperature).
- *Display+set (slave) DPT 6.010*: The room setpoint temperature can be changed on the web user interface.  
This setting functions only with ABB and Busch-Jaeger devices with the old master/slave interface with a group object of type DPT 6.010 (counter pulses).

# ABB i-bus<sup>®</sup> KNX

## Parameters

Selection of all options except *Display*:

Dependent parameter(s):

### Room setpoint temperature type

Options:            Absolute setpoint temperatures  
                      Relative setpoint temperatures

This parameter specifies whether the room thermostat uses absolute or relative room setpoint temperatures. This setting does not affect the indication on the web user interface.

- *Absolute setpoint temperatures*: The room thermostat uses absolute room setpoint temperatures e.g. 23 °C.  
For the new master/slave interface a group object of type DPT 9.001 is used.  
For the old master/slave interface a group object of type DPT 6.010 is used.
- *Relative setpoint temperatures*: The room thermostat uses relative room setpoint temperatures e.g. +3 K.  
For the new master/slave interface a group object of type DPT 9.002 is used.  
For the old master/slave interface a group object of type DPT 6.010 is used.

# ABB i-bus<sup>®</sup> KNX

## Parameters

### Controller On/Off

Options: None  
Display  
Display+set (slave)

This parameter specifies whether the On/Off status of the room thermostat received via KNX is only to be displayed on the web user interface, or it can also be changed by the user. The current value is output on the ASM output socket and in a BACnet object.

- *None*: The On/Off status of the room thermostat is not used in the module and can therefore not be displayed on the web user interface.
- *Display*: The On/Off status of the room thermostat from KNX is displayed on the web user interface. The current value is output on the ASM output socket and in a BACnet object
- *Display+set (slave)*: The room thermostat can be switched on or off via the web user interface. The command is sent via KNX to the room thermostat. The current value is output on the ASM output socket and in a BACnet object.  
This setting functions only with ABB and Busch-Jaeger devices with the old master/slave interface

### Heating/cooling operating type

Options: None  
Display  
Display+set (slave)

This parameter specifies whether the heating/cooling operating type from the room thermostat received via KNX is only to be displayed on the web user interface, or it can also be changed by the user. The current value is output on the ASM output socket and in a BACnet object.

- *None*: The heating/cooling operating type is not used in the module; this operating type is therefore not displayed on the web user interface.
- *Display*: The heating/cooling operating type from KNX is displayed on the web user interface. The current value is output on the ASM output socket and in a BACnet object.
- *Display+set (slave)*: The heating/cooling operating type can be changed on the web user interface and is sent via KNX. The current value is output on the ASM output socket and in a BACnet object.  
This setting functions only with ABB and Busch-Jaeger devices with the old master/slave interface

# ABB i-bus<sup>®</sup> KNX

## Parameters

### Operating mode

Options: None  
Display  
Display+set (slave)

This parameter specifies whether the room thermostat outputs the operating mode (Comfort, Standby, Economy, Building Protection) and whether this information is only to be output on the web user interface or can also be changed by the user.

- *None*: The operating mode is not used in the Room ASM and therefore not displayed on the web user interface.
- *Display*: The operating mode is displayed on the web user interface. The current value is output on the ASM output socket and in a BACnet object.
- *Display+set (slave)*: The operating mode can be changed on the web user interface. The current value is output on the ASM output socket and in a BACnet object. This setting functions only with ABB and Busch-Jaeger devices with the old master/slave interface.

### Window status

Options: No (checkbox cleared)  
Yes (checkbox selected)

This parameter specifies whether the room's window status is displayed on the web user interface and is to be output in the BACnet object and on the ASM output socket.

### Presence detector

Options: No (checkbox cleared)  
Yes (checkbox selected)

This parameter specifies whether the room's presence status is displayed on the web user interface and is to be output in the BACnet object and on the ASM output socket.

# ABB i-bus<sup>®</sup> KNX Parameters

## Rel. humidity

Options:            No (checkbox cleared)  
                         Yes (checkbox selected)

This parameter specifies whether the value measured for the relative humidity in the room is displayed on the web user interface and is to be output in the BACnet object and on the ASM output socket.

## CO2 value

Options:            No (checkbox cleared)  
                         Yes (checkbox selected)

This parameter specifies whether the value measured for the air quality in the room is displayed on the web user interface as a CO<sub>2</sub> value and is to be output in the BACnet object and on the ASM output socket.

## Fan coil unit

Options:            None  
                         2-pipe heating  
                         2-pipe cooling  
                         2-pipe heating/cooling  
                         4-pipe heating + cooling

Selects the fan coil unit (blower convector). The type selected affects the depiction on the web user interface and the number of valve control values.

- *None*: A fan coil unit is not used in the room.
- *2-pipe heating*: The fan coil unit can only heat
- *2-pipe cooling*: The fan coil unit can only cool
- *2-pipe heating/cooling*: The fan coil unit can heat and cool. It is only connected via 2 pipes that contain hot or cold water depending on the central operating type. It is therefore only ever possible to heat or cool; a central changeover is necessary to change.
- *4-pipe heating + cooling*: The fan coil unit can heat and cool. In a 4-pipe system, separate pipes are used for the hot and cold water supply. It is therefore possible to change between heating and cooling at any time. As such the room thermostat can select the heating/cooling operating type as required.

# ABB i-bus<sup>®</sup> KNX Parameters

Selection of all options except *None*:

Dependent parameter(s):

## **Fan coil unit, additional-stage heating**

Options:        None  
                  On/Off  
                  0...100%

Selection of the additional heating stage for peak load, e.g. an additional electrical heater.

- *None*: An additional heating stage is not used in the room.
- *On/Off*: The additional heating stage does not have multiple settings. KNX DPT 1.001 is used.
- *0...100%*: The additional heating stage has multiple settings. KNX DPT 5.001 is used.

## **Fan coil unit, fresh air damper**

Options:        None  
                  Open/Closed  
                  0...100%

Selects the fresh air damper. This can also be the status of a VAV box (Variable Air Volume).

- *None*: A fresh air damper is not used
- *Open/Closed*: The fresh air damper only has the two positions, open or closed. KNX DPT 1.001 is used.
- *0...100%*: The position of the fresh air damper can be controlled. KNX DPT 5.001 is used.

# ABB i-bus<sup>®</sup> KNX Parameters

## Fan coil unit, fan speed

Options:        Display  
                  Display+set (slave) DPT 5.001  
                  Display+set (slave) 5.010

This parameter specifies whether the fan speed set by the room thermostat is only to be displayed on the web user interface, or it can also be changed by the user. The current value is output on the ASM output socket and in a BACnet object.

- *Display*: The fan speed is only displayed on the web user interface and cannot be changed.
- *Display+set (slave) DPT 5.001*: The fan speed can be changed on the web user interface. This setting functions only with ABB and Busch-Jaeger devices with the new master/slave interface with group objects of type DPT 5.001
- *Display+set (slave) DPT 5.010*: The fan speed can be changed on the web user interface. This setting functions only with ABB and Busch-Jaeger devices with the old master/slave interface with group objects of type DPT 5.010.

Selection of *Display* or *Display+set (slave) DPT 5.001* option:

Dependent parameter(s):

### Fan coil unit, type of fan

Options:        On/Off  
                  3 stages  
                  5 stages  
                  Continuous fan 0...100%

Setting for the fan type. This setting must match the settings in the room thermostat.

- *On/Off*: Not a multiple stage fan type. The fan can only be switched on and off
- *3 stages*: Fan with 3 stages (0,1,2,3)
- *5 stages*: Fan with 5 stages (0,1,2,3,4,5)
- *Continuous fan 0...100%*: Continuous fan

# ABB i-bus<sup>®</sup> KNX Parameters

Selection of *Display+set (slave) DPT 5.010* option:

Dependent parameter(s):

### Fan coil unit, type of fan

Options:        3 stages  
                    5 stages

Setting for the fan type. This setting must match the settings in the room thermostat.

- 3 stages: Fan with 3 stages (0,1,2,3)
- 5 stages: Fan with 5 stages (0,1,2,3,4,5)

### Fan coil unit, dew point sensor

Options:        No (checkbox cleared)  
                    Yes (checkbox selected)

This parameter specifies whether the status of the fan coil unit's dew point sensor is displayed on the web user interface and is to be output in the BACnet object and on the ASM output socket.

### Fan coil unit, level sensor

Options:        No (checkbox cleared)  
                    Yes (checkbox selected)

This parameter specifies whether the status of the fan coil unit's level sensor is displayed on the web user interface and is to be output in the BACnet object and on the ASM output socket.



# ABB i-bus<sup>®</sup> KNX Parameters

## Radiator

Options:        None  
                  On/Off  
                  0...100%

Selects the radiator.

- *None*: A radiator is not used in the room
- *On/Off*: The radiator has a valve with the two settings open/closed, e.g. a solenoid valve. KNX DPT 1.001 is used.
- *0...100%*: The radiator has a continuous valve, e.g. a thermal or motorized valve. KNX DPT 5.001 is used.

## Floor heating

Options:        None  
                  On/Off  
                  0...100%

Selects the floor heating.

- *None*: Floor heating is not used in the room.
- *On/Off*: The floor heating has a valve with the two settings open/closed, e.g. a solenoid valve. KNX DPT 1.001 is used.
- *0...100%*: The floor heating has a continuous valve, e.g. a thermal or motorized valve. KNX DPT 5.001 is used.

Selection of *On/Off* and *0...100%* option:

Dependent parameter(s):

### Floor temperature sensor

Options:        No (checkbox cleared)  
                  Yes (checkbox selected)

This parameter specifies whether the value measured by the floor temperature sensor is displayed on the web user interface and is to be output in the BACnet object and on the ASM output socket.

# ABB i-bus® KNX Parameters

## Cooling ceiling

Options: None  
On/Off  
0...100%

Selects the cooling ceiling.

- *None*: A cooling ceiling is not used.
- *On/Off*: The cooling ceiling has a valve with the two settings open/closed, e.g. a solenoid valve. KNX DPT 1.001 is used.
- *0...100%*: The cooling ceiling has a continuous valve, e.g. a thermal or motorized valve. KNX DPT 5.001 is used.

Selection of *On/Off* and *0...100%* option:

Dependent parameter(s):

### Cooling ceiling, dew point alarm sensor

Options: No (checkbox cleared)  
Yes (checkbox selected)

This parameter specifies whether the status of the dew point alarm sensor is displayed on the web user interface and is to be output in the BACnet object and on the ASM output socket.

## Split unit

Options: No (checkbox cleared)  
Yes (checkbox selected)

This parameter specifies whether the status of a split unit (the usual terms are for example: split unit, air conditioner, AC) in the room is displayed on the web user interface and is to be output in the BACnet object and on the ASM output socket.

# ABB i-bus<sup>®</sup> KNX Parameters

## 7.7.3

### Sockets



Overview of the ASM sockets for linking to other modules:

Type	Object name	Data type
Output	Actual room temperature	9.001
Output	Room setpoint temperature	9.001
Output	Controller On/Off	1.001
Output	Heating/cooling operating type	1.100
Output	Operating mode	20.102
Output	Operating mode override (slave)	20.102
Output	Window status	1.019
Output	Presence detector	1.018
Output	Rel. humidity	5.001
Output	CO2 value	9.008
Output	Fan coil unit, valve heating	5.001
Output	Fan coil unit, valve cooling	5.001
Output	Fan coil unit, valve	5.001
Output	Fan coil unit, additional-stage heating	1.001
		5.001
Output	Fan coil unit, fresh air damper	1.019
		5.001
Output	Fan coil unit, fan speed	5.001
		5.010
Output	Fan coil unit, fan manual	1.011
Output	Fan coil unit, dew point sensor	1.001
Output	Fan coil unit, level sensor	1.001
Output	Radiator, valve	1.001
		5.001
Output	Floor heating, valve	1.001
		5.001
Output	Floor temperature sensor	9.001
Output	Cooling ceiling, valve	1.001
		5.001
Output	Cooling ceiling, dew point alarm sensor	1.001
Output	Split unit, On/Off	1.001
Output	Split unit, fan speed	5.001
Output	Split unit, status	20.105

#### Input sockets

None

# ABB i-bus<sup>®</sup> KNX

## Parameters

### Output sockets

Object name	Data type
<b>Actual room temperature</b>	<b>DPT 9.001</b>
Outputs the actual room temperature	
Signal value:       -273...670760 °C	
<b>Room setpoint temperature</b>	<b>DPT 9.001</b>
Outputs the current room setpoint temperature.	
Signal value:       -273...670760 °C	
<b>Controller On/Off</b>	<b>DPT 1.001</b>
The module has this output socket if any option except <i>None</i> is selected for the <a href="#">Controller On/Off</a> parameter.	
Outputs whether the room thermostat is switched on or off.	
Signal value:       0 = Off 1 = On	
<b>Heating/cooling operating type</b>	<b>DPT 1.100</b>
The module has this output socket if any option except <i>None</i> is selected for the <a href="#">Heating/cooling operating type</a> parameter.	
Outputs the current heating/cooling operating type.	
Signal value:       0 = Cooling 1 = Heating	
<b>Operating mode</b>	<b>DPT 20.102</b>
The module has this output socket if any option except <i>None</i> is selected for the <a href="#">Operating mode</a> parameter.	
Outputs the current HVAC operating mode.	
Signal value:       0 = Auto 1 = Comfort 2 = Standby 3 = Economy 4 = Building Protection	

# ABB i-bus<sup>®</sup> KNX Parameters

Object name	Data type
<b>Operating mode override (slave)</b>	<b>DPT 20.102</b>
<p>The module has this output socket if the <i>Display+set (slave)</i> option is selected for the <a href="#">Operating mode</a> parameter.</p> <p>Outputs the current overridden HVAC operating mode that can be overridden by a higher operating mode.</p> <p>Signal value:</p> <ul style="list-style-type: none"> <li>0 = Auto</li> <li>1 = Comfort</li> <li>2 = Standby</li> <li>3 = Economy</li> <li>4 = Building Protection</li> </ul>	
<b>Window status</b>	<b>DPT 1.019</b>
<p>The module has this output socket if the Yes option is selected for the <a href="#">Window status</a> parameter.</p> <p>Outputs the window status.</p> <p>Signal value:</p> <ul style="list-style-type: none"> <li>0 = Closed</li> <li>1 = Open</li> </ul>	
<b>Presence detector</b>	<b>DPT 1.018</b>
<p>The module has this output socket if the Yes option is selected for the <a href="#">Presence detector</a> parameter.</p> <p>Outputs the presence status.</p> <p>Signal value:</p> <ul style="list-style-type: none"> <li>0 = Not occupied</li> <li>1 = Occupied</li> </ul>	
<b>Rel. humidity</b>	<b>DPT 5.001</b>
<p>The module has this output socket if the Yes option is selected for the <a href="#">Rel. humidity</a> parameter.</p> <p>Outputs the relative humidity.</p> <p>Signal value:</p> <ul style="list-style-type: none"> <li>0...100%</li> </ul>	

# ABB i-bus<sup>®</sup> KNX Parameters

Object name	Data type
<b>CO2 value</b>	<b>DPT 9.008</b>
<p>The module has this output socket if the <i>Yes</i> option is selected for the <a href="#">CO2 value</a> parameter.</p> <p>Outputs the air quality (CO<sub>2</sub>)</p> <p>Signal value: 0...670760 ppm</p>	
<b>Fan coil unit, valve heating</b>	<b>DPT 5.001</b>
<p>The module has this output socket if the <i>2-pipe heating</i> option or the <i>4-pipe heating + cooling</i> option is selected for the <a href="#">Fan coil unit</a> parameter.</p> <p>Outputs the valve position (control value) on the fan coil unit for heating.</p> <p>Signal value: 0...100%</p>	
<b>Fan coil unit, valve cooling</b>	<b>DPT 5.001</b>
<p>The module has this output socket if the <i>2-pipe cooling</i> option or the <i>4-pipe heating + cooling</i> option is selected for the <a href="#">Fan coil unit</a> parameter.</p> <p>Outputs the valve position (control value) on the fan coil unit for cooling.</p> <p>Signal value: 0...100%</p>	
<b>Fan coil unit, valve</b>	<b>DPT 5.001</b>
<p>The module has this output socket if the <i>2-pipe heating/cooling</i> option is selected for the <a href="#">Fan coil unit</a> parameter.</p> <p>Outputs the valve position (control value) on the fan coil unit. This is for either heating or cooling depending on the heating/cooling operating type.</p> <p>Signal value: 0...100%</p>	

# ABB i-bus<sup>®</sup> KNX Parameters

Object name	Data type
<b>Fan coil unit, additional-stage heating</b>	<b>DPT 1.001</b> <b>DPT 5.001</b>
<p>The data point type for the output socket is dependent on the settings in the module:</p> <ul style="list-style-type: none"> <li>• If any option except <i>None</i> is selected for the <a href="#">Fan coil unit</a> parameter and the <i>On/Off</i> option is selected for the <a href="#">Fan coil unit, additional-stage heating</a> parameter: DPT 1.001 Signal value: 0 = Off, 1 = On</li> <li>• If any option except <i>None</i> is selected for the <a href="#">Fan coil unit</a> parameter and the <i>0...100%</i> option is selected for the <a href="#">Fan coil unit, Fan coil unit, additional-stage heating</a> parameter: DPT 5.001 Signal value: 0...100%</li> </ul> <p>Outputs the status of the additional-stage heating</p>	
<b>Fan coil unit, fresh air damper</b>	<b>DPT 1.019</b> <b>DPT 5.001</b>
<p>The data point type for the output socket is dependent on the settings in the module:</p> <ul style="list-style-type: none"> <li>• If any option except <i>None</i> is selected for the <a href="#">Fan coil unit</a> parameter and the <i>Open/Closed</i> option is selected for the <a href="#">Fan coil unit, fresh air damper</a> parameter: DPT 1.019 Signal value: 0 = Closed, 1 = Open</li> <li>• If any option except <i>None</i> is selected for the <a href="#">Fan coil unit</a> parameter and the <i>0...100%</i> option is selected for the <a href="#">Fan coil unit, fresh air damper</a> parameter: DPT 5.001 Signal value: 0...100%</li> </ul> <p>Outputs the position of the fresh air damper.</p>	
<b>Fan coil unit, fan speed</b>	<b>DPT 5.001</b> <b>DPT 5.010</b>
<p>The data point type for the output socket is dependent on the settings in the module.</p> <ul style="list-style-type: none"> <li>• If any option except <i>None</i> is selected for the <a href="#">Fan coil unit</a> parameter and the <i>Display</i> or <i>Display+set (slave)</i> <a href="#">DPT 5.001</a> option is selected for the <a href="#">Fan coil unit, fan speed</a> parameter: DPT 5.001 Signal value: 0...100%</li> <li>• If any option except <i>None</i> is selected for the <a href="#">Fan coil unit</a> parameter and the <i>Display+set (slave)</i> <a href="#">DPT 5.010</a> option is selected for the <a href="#">Fan coil unit, fan speed</a> parameter: DPT 5.010 Signal value: 0...5</li> </ul> <p>Outputs the current fan speed.</p>	

# ABB i-bus<sup>®</sup> KNX Parameters

Object name	Data type
<b>Fan coil unit, fan manual</b>	<b>DPT 1.011</b>
<p>The module has this output socket if any option except <i>None</i> is selected for the <a href="#">Fan coil unit</a> parameter.</p> <p>Outputs whether the current fan speed has been adjusted manually by a user or it was calculated automatically by the room thermostat.</p> <p>Signal value:        0 = Automatic                           1 = Manual</p>	
<b>Fan coil unit, dew point sensor</b>	<b>DPT 1.001</b>
<p>The module has this output socket if any option except <i>None</i> is selected for the <a href="#">Fan coil unit</a> parameter and the <i>Yes</i> option is selected for the <a href="#">Fan coil unit, dew point sensor</a> parameter.</p> <p>Outputs the signal value from the dew point sensor in the fan coil unit.</p> <p>Signal value:        0 = Off                           1 = On</p>	
<b>Fan coil unit, level sensor</b>	<b>DPT 1.001</b>
<p>The module has this output socket if any option except <i>None</i> is selected for the <a href="#">Fan coil unit</a> parameter and the <i>Yes</i> option is selected for the <a href="#">Fan coil unit, level sensor</a> parameter.</p> <p>Outputs the signal value from the level sensor in the fan coil unit.</p> <p>Signal value:        0 = Off                           1 = On</p>	
<b>Radiator, valve</b>	<b>DPT 1.001 DPT 5.001</b>
<p>The data point type for the output socket is dependent on the settings in the module.</p> <ul style="list-style-type: none"> <li>• If the <i>On/Off</i> option is selected for the <a href="#">Radiator</a> parameter: DPT 1.001 Signal value: 0 = Off, 1 = On</li> <li>• If the <i>0...100 %</i> option is selected for the <a href="#">Radiator</a> parameter: DPT 5.001 Signal value: 0...100 %</li> </ul> <p>Outputs the position of the radiator valve.</p>	



# ABB i-bus<sup>®</sup> KNX Parameters

Object name	Data type
<b>Floor heating, valve</b>	<b>DPT 1.001</b> <b>DPT 5.001</b>
<p>The data point type for the output socket is dependent on the settings in the module.</p> <ul style="list-style-type: none"> <li>If the <i>On/Off</i> option is selected for the <a href="#">Floor heating</a> parameter: DPT 1.001 Signal value: 0 = Off, 1 = On</li> <li>If the <i>0...100 %</i> option is selected for the <a href="#">Floor heating</a> parameter: DPT 5.001 Signal value: 0...100 %</li> </ul> <p>Outputs the position of the floor heating valve.</p>	
<b>Floor temperature sensor</b>	<b>DPT 9.001</b>
<p>The module has this output socket if the <i>On/Off</i> option or the <i>0...100 %</i> option is selected for the <a href="#">Floor heating</a> parameter and the <i>Yes</i> option is selected for the <a href="#">Floor temperature sensor</a> parameter.</p> <p>Outputs the floor temperature.</p> <p>Signal value:           -273...670760 °C</p>	
<b>Cooling ceiling, valve</b>	<b>DPT 1.001</b> <b>DPT 5.001</b>
<p>The data point type for the output socket is dependent on the settings in the module.</p> <ul style="list-style-type: none"> <li>If the <i>On/Off</i> option is selected for the <a href="#">Cooling ceiling</a> parameter: DPT 1.001 Signal value: 0 = Off, 1 = On</li> <li>If the <i>0...100 %</i> option is selected for the <a href="#">Cooling ceiling</a> parameter: DPT 5.001 Signal value: 0...100 %</li> </ul> <p>Outputs the position of the cooling ceiling valve.</p>	
<b>Cooling ceiling, dew point alarm sensor</b>	<b>DPT 1.001</b>
<p>The module has this output socket if the <i>On/Off</i> option or the <i>0...100 %</i> option is selected for the <a href="#">Cooling ceiling</a> parameter and the <i>Yes</i> option is selected for the <a href="#">Cooling ceiling, dew point alarm sensor</a> parameter.</p> <p>Outputs the signal value from the dew point sensor in the cooling ceiling.</p> <p>Signal value:           0 = Off                               1 = On</p>	

# ABB i-bus<sup>®</sup> KNX Parameters

Object name	Data type
<b>Split unit, On/Off</b>	<b>DPT 1.001</b>
<p>The module has this output socket if the Yes option is selected for the <a href="#">Split unit</a> parameter.</p> <p>Outputs the operating status of the split unit.</p> <p>Signal value:        0 = Off                           1 = On</p>	
<b>Split unit, fan speed</b>	<b>DPT 5.001</b>
<p>The module has this output socket if the Yes option is selected for the <a href="#">Split unit</a> parameter.</p> <p>Outputs the fan speed in the split unit.</p> <p>Signal value:        0...100 %</p>	
<b>Split unit, status</b>	<b>DPT 20.105</b>
<p>The module has this output socket if the Yes option is selected for the <a href="#">Split unit</a> parameter.</p> <p>Outputs the status of the split unit.</p> <p>Signal value:        0 = Auto                           1 = Heat                           2 = Morning Warmup                           3 = Cool                           4 = Night Purge                           5 = Precool                           6 = Off                           7 = Test                           8 = Emergency Heat                           9 = Fan only                           0A = Free Cool                           0B = Ice                           0C = Maximum Heat Mode                           0D = Economic Heat/Cool Mode                           0E = Dehumidification                           0F = Calibration Mode                           10 = Emergency Cool Mode                           11 = Emergency Steam Mode                           14 = No Dem</p>	

# ABB i-bus<sup>®</sup> KNX Parameters

## 7.7.4

### Group objects

Object function	Name (can be changed separately)	Data point type (DPT)	Length	Flags					
				C	R	W	T	U	I
Input: Actual room temperature	Room	9.001	2 bytes	x	x	x	x		
Input: Room setpoint temperature	Room	9.001	2 bytes	x	x	x	x	x	
Output: Setpoint temperature request (slave)	Room	9.001	2 bytes	x		x			
		9.002	2 bytes						
		6.010	1 byte						
Input: Setpoint temperature confirm (slave)	Room	9.001	2 bytes	x	x	x	x	x	
		9.002	2 bytes						
		6.010	1 byte						
Input: On/Off	Room	1.001	1 bit	x	x	x	x		
Input: On/Off confirm (slave)	Room	1.001	1 bit	x	x	x	x		
Output: On/Off request (slave)	Room	1.001	1 bit	x		x			
Input: Heating/cooling operating type	Room	1.100	1 bit	x	x	x	x		
Output: Heating/cooling request (slave)	Room	1.100	1 bit	x		x			
Input: Operating mode	Room	20.102	1 byte	x	x	x	x		
Input: Controller Status HVAC (slave)	Room	5.010	1 byte	x	x	x	x		
Output: Operating mode normal (slave)		20.102	1 byte	x		x			
Input: Operating mode override (slave)	Room	20.102	1 byte	x	x	x	x		
Input: Window status	Room	1.019	1 bit	x	x	x	x		
Input: Presence (slave)	Room	1.018	1 bit	x	x	x	x		
Input: Rel. humidity	Room	5.001	1 byte	x	x	x	x		
Input: CO2 value	Room	9.008	2 bytes	x	x	x	x		
Input: Fan coil unit, valve heating	Room	5.001	1 byte	x	x	x	x		
Input: Fan coil unit, valve cooling	Room	5.001	1 byte	x	x	x	x		
Input: Fan coil unit, valve	Room	5.001	1 byte	x	x	x	x		
Input: Fan coil unit, fan speed	Room	5.001	1 byte	x	x	x	x		
Input: Fan coil unit, fan manual	Room	1.011	1 bit	x	x	x	x		
Input: Fan coil unit, fan speed confirm (slave)	Room	5.001	1 byte	x	x	x	x		
		5.010	1 byte						
Input: Fan coil unit, fan manual confirm (slave)	Room	1.011	1 bit	x	x	x	x		
Output: Fan coil unit, fan speed request (slave)	Room	5.001	1 byte	x		x			
		5.010	1 byte						
Output: Request fan manually (slave)	Room	1.011	1 bit	x		x			

# ABB i-bus® KNX Parameters

Object function	Name (can be changed separately)	Data point type (DPT)	Length	Flags					
				C	R	W	T	U	I
Input: Fan coil unit, additional-stage heating	Room	1.001	1 bit	x	x	x	x		
		5.001	1 byte						
Input: Fan coil unit, fresh air damper	Room	1.019	1 bit	x	x	x	x		
		5.001	1 byte						
Input: Fan coil unit, dew point sensor	Room	1.001	1 bit	x	x	x	x		
Input: Fan coil unit, level sensor	Room	1.001	1 bit	x	x	x	x		
Input: Radiator, valve	Room	1.001	1 bit	x	x	x	x		
		5.001	1 byte						
Input: Floor heating, valve	Room	1.001	1 bit	x	x	x	x		
		5.001	1 byte						
Input: Floor temperature sensor	Room	9.001	2 bytes	x	x	x	x		
Input: Cooling ceiling, valve	Room	1.001	1 bit	x	x	x	x		
		5.001	1 byte						
Input: Cooling ceiling, dew point alarm sensor	Room	9.001	2 bytes	x	x	x	x		
Input: Split unit, On/Off	Room	1.001	1 bit	x	x	x	x		
Input: Split unit, fan speed	Room	5.001	1 byte	x	x	x	x		
Input: Split unit, status	Room	20.105	1 byte	x	x	x	x		

# ABB i-bus<sup>®</sup> KNX Parameters

Object function	Name (can be changed separately)	Data type	Flags
<b>Input: Actual room temperature</b>	<b>Room</b>	<b>2 bytes DPT 9.001</b>	<b>C, W, T, U</b>
Input for the connection of the room temperature from the room thermostat.  Telegram value:     -273...670760 °C			
<b>Input: Room setpoint temperature</b>	<b>Room</b>	<b>2 bytes DPT 9.001</b>	<b>C, W, T, U, I</b>
The module has this group object if the <i>Display</i> option is selected for the <a href="#">Room setpoint temperature</a> parameter.  Input for the connection of the setpoint temperature from the room thermostat.  Telegram value:     -273...670760 °C			
<b>Output: Setpoint temperature request (slave)</b>	<b>Room</b>	<b>2 bytes DPT 9.001 2 bytes DPT 9.002 1 byte DPT 6.010</b>	<b>C, T</b>
This group object is used to transmit a setpoint change between the Room ASM slave and the room thermostat (master). The data point type for the group object is dependent on the settings in the module: <ul style="list-style-type: none"> <li>• If the <i>Display+set (slave) DPT 9.001/DPT 9.002</i> option is selected for the <a href="#">Room setpoint temperature</a> parameter and the <i>Absolute setpoint temperatures</i> option is selected for the <a href="#">Room setpoint temperature type</a> parameter: DPT 9.001 Signal value 273...670760 °C An absolute setpoint adjustment is transmitted, e.g. 22 °C</li> <li>• If the <i>Display+set (slave) DPT 9.001/DPT 9.002</i> option is selected for the <a href="#">Room setpoint temperature</a> parameter and the <i>Relative setpoint temperatures</i> option is selected for the <a href="#">Room setpoint temperature type</a> parameter: DPT 9.002 Signal value -67760...670760 K A relative setpoint adjustment is transmitted, e.g. -2 K</li> <li>• If the <i>Display+set (slave) DPT 6.010</i> option is selected for the <a href="#">Room setpoint temperature</a> parameter: DPT 6.010 Signal value -128...127 With this method, the temperature is converted to an integer value before it is sent and the adjustment is transmitted in steps.</li> </ul>			

# ABB i-bus<sup>®</sup> KNX Parameters

Object function	Name (can be changed separately)	Data type	Flags
<b>Input: Setpoint temperature confirm (slave)</b>	<b>Room</b>	<b>2 bytes DPT 9.001 2 bytes DPT 9.002 1 byte DPT 6.010</b>	<b>C, W, T, U, I</b>
<p>This group object is used to transmit a setpoint change between the Room ASM slave and the room thermostat (master). The data point type for the group object is dependent on the settings in the module:</p> <ul style="list-style-type: none"> <li>• If the <i>Display+set (slave) DPT 9.001/DPT 9.002</i> option is selected for the <a href="#">Room setpoint temperature</a> parameter and the <i>Absolute setpoint temperatures</i> option is selected for the <a href="#">Room setpoint temperature type</a> parameter: DPT 9.001 Signal value 273...670760 °C An absolute setpoint adjustment is transmitted, e.g. 22 °C</li> <li>• If the <i>Display+set (slave) DPT 9.001/DPT 9.002</i> option is selected for the <a href="#">Room setpoint temperature</a> parameter and the <i>Relative setpoint temperatures</i> option is selected for the <a href="#">Room setpoint temperature type</a> parameter: DPT 9.002 Signal value -67760...670760 K A relative setpoint adjustment is transmitted, e.g. -2 K</li> <li>• If the <i>Display+set (slave) DPT 6.010</i> option is selected for the <a href="#">Room setpoint temperature</a> parameter: DPT 6.010 Signal value -128...127 With this method, the temperature is converted to an integer value before it is sent and the adjustment is transmitted in steps.</li> </ul>			
<b>Input: On/Off</b>	<b>Room</b>	<b>1 bit DPT 1.001</b>	<b>C, W, T, U</b>
<p>The module has this group object if the <i>Display</i> option is selected for the <a href="#">Controller On/Off</a> parameter.</p> <p>Input for the connection of the on/off status of the room thermostat.</p> <p>Telegram value:       0 = Off                           1 = On</p>			

# ABB i-bus<sup>®</sup> KNX Parameters

Object function	Name (can be changed separately)	Data type	Flags
<b>Input: On/Off confirm (slave)</b>	<b>Room</b>	<b>1 bit DPT 1.001</b>	<b>C, W, T, U</b>
<p>The module has this group object if the <i>Display+set (slave)</i> option is selected for the <a href="#">Controller On/Off</a> parameter.</p> <p>This group object is used for synchronization between the Room ASM (slave) and the room thermostat (master). For this purpose the group object must be connected to the controller's (master's) group object of the same name. In this group object the room thermostat (master) confirms to the Room ASM (slave) whether it is currently switched on or off</p> <p>Telegram value:     0 = Off                       1 = On</p>			
<b>Output: On/Off request (slave)</b>	<b>Room</b>	<b>1 bit DPT 1.001</b>	<b>C, T</b>
<p>The module has this group object if the <i>Display+set (slave)</i> option is selected for the <a href="#">Controller On/Off</a> parameter.</p> <p>This group object is used for synchronization between the Room ASM (slave) and the room thermostat (master). For this purpose the group object must be connected to the controller's (master's) group object of the same name. The Room ASM sends the switch on or switch off request to the controller in this group object.</p> <p>Telegram value:     0 = Off                       1 = On</p>			
<b>Input: Heating/cooling operating type</b>	<b>Room</b>	<b>1 bit DPT 1.100</b>	<b>C, W, T, U</b>
<p>The module has this group object if the <i>Display</i> option is selected for the <a href="#">Heating/cooling operating type</a> parameter.</p> <p>Input for the connection of the heating/cooling operating type from the room thermostat.</p> <p>Telegram value:     0 = Cooling                       1 = Heating</p>			

# ABB i-bus<sup>®</sup> KNX Parameters

Object function	Name (can be changed separately)	Data type	Flags
<b>Output: Heating/cooling request (slave)</b>	<b>Room</b>	<b>1 bit DPT 1.100</b>	<b>C, T</b>
<p>The module has this group object if the <i>Display+set (slave)</i> option is selected for the <a href="#">Heating/cooling operating type</a> parameter.</p> <p>This group object is used for synchronization of the heating/cooling status between the Room ASM (slave) and the room thermostat (master). For this purpose the group object must be connected to the controller's (master's) group object of the same name. The Room ASM sends the changeover request to the controller in this group object.</p> <p>Telegram value:      0 = Cooling                           1 = Heating</p>			
<b>Input: Operating mode</b>	<b>Room</b>	<b>1 byte DPT 20.102</b>	<b>C, W, T, U</b>
<p>The module has this group object if the <i>Display</i> option is selected for the <a href="#">Operating mode</a> parameter.</p> <p>Input for the connection of the operating mode from the room thermostat.</p> <p>Telegram value:      0 = Auto                           1 = Comfort                           2 = Standby                           3 = Economy                           4 = Building Protection</p>			
<b>Input: Controller Status HVAC (slave)</b>	<b>Room</b>	<b>1 byte DPT 5.001</b>	<b>C, W, T, U</b>
<p>The module has this group object if the <i>Display+set (slave)</i> option is selected for the <a href="#">Operating mode</a> parameter.</p> <p>Input for the connection of the controller status HVAC from the room thermostat. The information contained in this status is required by the module to display and set the operating mode.</p> <p>Telegram value:      non-DPT</p>			



# ABB i-bus<sup>®</sup> KNX Parameters

Object function	Name (can be changed separately)	Data type	Flags
<b>Output: Operating mode normal (slave)</b>	<b>Room</b>	<b>1 byte DPT 20.102</b>	<b>C, T</b>
<p>The module has this group object if the <i>Display+set (slave)</i> option is selected for the <a href="#">Operating mode</a> parameter.</p> <p>This group object is used for synchronization of the operating mode between the Room ASM (slave) and the room thermostat (master). For this purpose the group object must be connected to the controller's (master's) group object of the same name. The Room ASM sends the operating mode to the controller in this group object.</p> <p>Telegram value:      0 = Auto                                    1 = Comfort                                    2 = Standby                                    3 = Economy                                    4 = Building Protection</p>			
<b>Input: Operating mode override (slave)</b>	<b>Room</b>	<b>1 byte DPT 20.102</b>	<b>C, W, T, U</b>
<p>The module has this group object if the <i>Display+set (slave)</i> option is selected for the <a href="#">Operating mode</a> parameter.</p> <p>This group object is used for synchronization of the overridden operating mode between the Room ASM (slave) and the room thermostat (master). For this purpose the group object must be connected to the controller's (master's) group object of the same name. The Room ASM receives the current overridden operating mode from the controller in this group object.</p> <p>Telegram value:      0 = Auto                                    1 = Comfort                                    2 = Standby                                    3 = Economy                                    4 = Building Protection</p>			
<b>Input: Window status</b>	<b>Room</b>	<b>1 bit DPT 1.019</b>	<b>C, W, T, U</b>
<p>The module has this group object if the Yes option is selected for the <a href="#">Window status</a> parameter.</p> <p>Input for the connection of the window status.</p> <p>Telegram value:      0 = Closed                                    1 = Open</p>			

# ABB i-bus® KNX Parameters

Object function	Name (can be changed separately)	Data type	Flags
<b>Input: Presence (slave)</b>	<b>Room</b>	<b>1 bit DPT 1.018</b>	<b>C, W, T, U</b>
<p>The module has this group object if the Yes option is selected for the <a href="#">Presence detector</a> parameter.</p> <p>Input for the connection of the presence status, e.g. from a presence detector.</p> <p>Telegram value:      0 = Not occupied                           1 = Occupied</p>			
<b>Input: Rel. humidity</b>	<b>Room</b>	<b>1 byte DPT 5.001</b>	<b>C, W, T, U</b>
<p>The module has this group object if the Yes option is selected for the <a href="#">Rel. humidity</a> parameter.</p> <p>Input for the connection of the relative humidity from the sensor.</p> <p>Telegram value:      0...100%</p>			
<b>Input: CO2 value</b>	<b>Room</b>	<b>2 bytes DPT 9.008</b>	<b>C, W, T, U</b>
<p>The module has this group object if the Yes option is selected for the <a href="#">CO2 value</a> parameter.</p> <p>Input for the connection of the CO<sub>2</sub> value from the air quality sensor.</p> <p>Telegram value:      0...670760</p>			
<b>Input: Fan coil unit, valve heating</b>	<b>Room</b>	<b>1 byte DPT 5.001</b>	<b>C, W, T, U</b>
<p>The module has this group object if the <i>2-pipe heating</i> option or the <i>4-pipe heating + cooling</i> option is selected for the <a href="#">Fan coil unit</a> parameter.</p> <p>Input for the valve position (control value) on the fan coil unit for heating.</p> <p>Telegram value:      0...100%</p>			

# ABB i-bus<sup>®</sup> KNX Parameters

Object function	Name (can be changed separately)	Data type	Flags
<b>Input: Fan coil unit, valve cooling</b>	<b>Room</b>	<b>1 byte DPT 5.001</b>	<b>C, W, T, U</b>
<p>The module has this group object if the <i>2-pipe cooling</i> option or the <i>4-pipe heating + cooling</i> option is selected for the <a href="#">Fan coil unit</a> parameter.</p> <p>Input for the valve position (control value) on the fan coil unit for cooling.</p> <p>Telegram value: 0...100%</p>			
<b>Input: Fan coil unit, valve</b>	<b>Room</b>	<b>1 byte DPT 5.001</b>	<b>C, W, T, U</b>
<p>The module has this group object if the <i>2-pipe heating/cooling</i> option is selected for the <a href="#">Fan coil unit</a> parameter.</p> <p>Input for the valve position (control value) on the fan coil unit. This is for either heating or cooling depending on the heating/cooling operating type.</p> <p>Telegram value: 0...100%</p>			
<b>Input: Fan coil unit, fan speed</b>	<b>Room</b>	<b>1 byte DPT 5.001</b>	<b>C, W, T, U</b>
<p>The module has this group object if any option except <i>None</i> is selected for the <a href="#">Fan coil unit</a> parameter and the <i>Display</i> option is selected for the <a href="#">Fan coil unit, fan speed</a> parameter.</p> <p>Input for the fan speed on the fan coil unit.</p> <p>Telegram value: 0...100%</p>			
<b>Input: Fan coil unit, fan manual</b>	<b>Room</b>	<b>1 bit DPT 1.011</b>	<b>C, W, T, U</b>
<p>The module has this group object if any option except <i>None</i> is selected for the <a href="#">Fan coil unit</a> parameter and the <i>Display</i> option is selected for the <a href="#">Fan coil unit, fan speed</a> parameter.</p> <p>Input for the connection of the status from the room thermostat as to whether the current fan speed has been adjusted manually by a user or it was calculated automatically by the room thermostat.</p> <p>Telegram value: 0 = Automatic 1 = Manual</p>			

# ABB i-bus<sup>®</sup> KNX Parameters

Object function	Name (can be changed separately)	Data type	Flags
<b>Input: Fan coil unit, fan speed confirm (slave)</b>	<b>Room</b>	<b>1 byte DPT 5.001 1 byte DPT 5.010</b>	<b>C, W, T, U</b>
<p>This group object is used for synchronization of the fan speed status between the Room ASM (slave) and the room thermostat (master). For this purpose the group object must be connected to the controller's (master's) group object of the same name. In this group object the room thermostat (master) confirms the change in the fan speed to the Room ASM (slave).</p> <p>The data point type for the group object is dependent on the settings in the module:</p> <ul style="list-style-type: none"> <li>• If any option except <i>None</i> is selected for the <a href="#">Fan coil unit</a> parameter and the <i>Display+set (slave) DPT 5.001</i> option is selected for the <a href="#">Fan coil unit, fan speed</a> parameter: DPT 5.001 Telegram value 0...100 % The fan speed in percent is transmitted, e.g. 50 %. Fan speeds are converted into the corresponding percentage.</li> <li>• If any option except <i>None</i> is selected for the <a href="#">Fan coil unit</a> parameter and the <i>Display+set (slave) DPT 5.010</i> option is selected for the <a href="#">Fan coil unit, fan speed</a> parameter: DPT 5.010 Telegram value 0 ... 5 The fan speed is transmitted</li> </ul>			
<b>Input: Fan coil unit, fan manual confirm (slave)</b>	<b>Room</b>	<b>1 bit DPT 1.011</b>	<b>C, W, T, U</b>
<p>The module has this group object if any option except <i>None</i> is selected for the <a href="#">Fan coil unit</a> parameter and the <i>Display+set (slave) DPT 5.001</i> option or <i>Display+Set (Slave) DPT 5.010</i> option is selected for the <a href="#">Fan coil unit, fan speed</a> parameter.</p> <p>This group object is used for synchronization of the fan speed status between the Room ASM (slave) and the room thermostat (master). For this purpose the group object must be connected to the controller's (master's) group object of the same name. In this group object the room thermostat (master) confirms to the Room ASM (slave) whether the current fan speed has been adjusted manually by a user or it was calculated automatically by the room thermostat.</p> <p>Telegram value:    0 = Automatic                       1 = Manual</p>			

# ABB i-bus<sup>®</sup> KNX Parameters

Object function	Name (can be changed separately)	Data type	Flags
<b>Output: Fan coil unit, fan speed request (slave)</b>	<b>Room</b>	<b>1 byte DPT 5.001 1 Byte DPT 5.010</b>	<b>C, T</b>
<p>This group object is used for synchronization of the fan speed status between the Room ASM (slave) and the room thermostat (master). For this purpose the group object must be connected to the controller's (master's) group object of the same name. The Room ASM (slave) sends the request to change the fan speed to the controller (master) in this group object.</p> <p>The data point type for the group object is dependent on the settings in the module:</p> <ul style="list-style-type: none"> <li>• If any option except <i>None</i> is selected for the <a href="#">Fan coil unit</a> parameter and the <i>Display+set (slave) DPT 5.001</i> option is selected for the <a href="#">Fan coil unit, fan speed</a> parameter: DPT 5.001 Telegram value 0...100 % The fan speed in percent is transmitted, e.g. 50 %. Fan speeds are converted into the corresponding percentage.</li> <li>• If any option except <i>None</i> is selected for the <a href="#">Fan coil unit</a> parameter and the <i>Display+set (slave) DPT 5.010</i> option is selected for the <a href="#">Fan coil unit, fan speed</a> parameter: DPT 5.010 Telegram value 0 ... 5 The fan speed is transmitted</li> </ul>			
<b>Output: Request fan manually (slave)</b>	<b>Room</b>	<b>1 bit DPT 1.011</b>	<b>C, T</b>
<p>The module has this group object if any option except <i>None</i> is selected for the <a href="#">Fan coil unit</a> parameter and the <i>Display+set (slave) DPT 5.001</i> option or <i>Display+Set (Slave) DPT 5.010</i> option is selected for the <a href="#">Fan coil unit, fan speed</a> parameter.</p> <p>This group object is used for synchronization of the fan speed status between the Room ASM (slave) and the room thermostat (master). For this purpose the group object must be connected to the controller's (master's) group object of the same name. The Room ASM (slave) sends the request to change the fan speed manually to the controller (master) in this group object.</p> <p>Telegram value:     0 = Automatic                           1 = Manual</p>			

# ABB i-bus<sup>®</sup> KNX Parameters

Object function	Name (can be changed separately)	Data type	Flags
<b>Input: Fan coil unit, additional-stage heating</b>	<b>Room</b>	<b>1 bit DPT 1.001 1 byte DPT 5.001</b>	<b>C, W, T, U</b>
<p>Input for the control value for the additional-stage heating on the fan coil unit.</p> <p>The data point type for the group object is dependent on the settings in the module:</p> <ul style="list-style-type: none"> <li>• If any option except <i>None</i> is selected for the <a href="#">Fan coil unit</a> parameter and the <i>On/Off</i> option is selected for the <a href="#">Fan coil unit, additional-stage heating</a> parameter: DPT 1.001 Telegram value 0 = Off, 1 = On</li> <li>• If any option except <i>None</i> is selected for the <a href="#">Fan coil unit</a> parameter and the <i>0...100 %</i> option is selected for the <a href="#">Fan coil unit, additional-stage heating</a> parameter: DPT 5.001 Telegram value 0...100 %</li> </ul>			
<b>Input: Fan coil unit, fresh air damper</b>	<b>Room</b>	<b>1 bit DPT 1.019 1 byte DPT 5.001</b>	<b>C, W, T, U</b>
<p>Input for the position of the fresh air damper.</p> <p>The data point type for the group object is dependent on the settings in the module:</p> <ul style="list-style-type: none"> <li>• If any option except <i>None</i> is selected for the <a href="#">Fan coil unit</a> parameter and the <i>Open/Closed</i> option is selected for the <a href="#">Fan coil unit, fresh air damper</a> parameter: DPT 1.019 Telegram value 0 = Closed, 1 = Opened</li> <li>• If any option except <i>None</i> is selected for the <a href="#">Fan coil unit</a> parameter and the <i>0...100 %</i> option is selected for the <a href="#">Fan coil unit, fresh air damper</a> parameter: DPT 5.001 Telegram value 0...100 %</li> </ul>			
<b>Input: Fan coil unit, dew point sensor</b>	<b>Room</b>	<b>1 bit DPT 1.001</b>	<b>C, W, T, U</b>
<p>The module has this group object if any option except <i>None</i> is selected for the <a href="#">Fan coil unit</a> parameter and the <i>Yes</i> option is selected for the <a href="#">Fan coil unit, dew point sensor</a> parameter.</p> <p>Input for the signal value from the dew point sensor in the fan coil unit.</p> <p>Telegram value:       0 = Off                           1 = On</p>			

# ABB i-bus<sup>®</sup> KNX Parameters

Object function	Name (can be changed separately)	Data type	Flags
<b>Input: Fan coil unit, level sensor</b>	<b>Room</b>	<b>1 bit DPT 1.001</b>	<b>C, W, T, U</b>
<p>The module has this group object if any option except <i>None</i> is selected for the <a href="#">Fan coil unit</a> parameter and the <i>Yes</i> option is selected for the <i>Fan coil unit, level sensor</i> parameter.</p> <p>Input for the signal value from the level sensor in the fan coil unit.</p> <p>Telegram value:      0 = Off                              1 = On</p>			
<b>Input: Radiator, valve</b>	<b>Room</b>	<b>1 bit DPT 1.001 1 byte DPT 5.001</b>	<b>C, W, T, U</b>
<p>Input for the position (control value) of the radiator valve.</p> <p>The data point type for the group object is dependent on the settings in the module:</p> <ul style="list-style-type: none"> <li>• If the <i>On/Off</i> option is selected for the <a href="#">Radiator</a> parameter: DPT 1.001 Telegram value 0 = Off, 1 = On</li> <li>• If the <i>0...100 %</i> option is selected for the <a href="#">Radiator</a> parameter: DPT 5.001 Telegram value 0...100 %</li> </ul>			
<b>Input: Floor heating, valve</b>	<b>Room</b>	<b>1 bit DPT 1.001 1 byte DPT 5.001</b>	<b>C, W, T, U</b>
<p>Input for the position (control value) of the floor heating valve.</p> <p>The data point type for the group object is dependent on the settings in the module:</p> <ul style="list-style-type: none"> <li>• If the <i>On/Off</i> option is selected for the <a href="#">Floor heating</a> parameter: DPT 1.001 Telegram value 0 = Off, 1 = On</li> <li>• If the <i>0...100 %</i> option is selected for the <a href="#">Floor heating</a> parameter: DPT 5.001 Telegram value 0...100 %</li> </ul>			

# ABB i-bus<sup>®</sup> KNX Parameters

Object function	Name (can be changed separately)	Data type	Flags
<b>Input: Floor temperature sensor</b>	<b>Room</b>	<b>2 bytes DPT 9.001</b>	<b>C, W, T, U</b>
<p>The module has this group object if the <i>On/Off</i> option or the <i>0...100 %</i> option is selected for the <a href="#">Floor heating</a> parameter and the <i>Yes</i> option is selected for the <i>Floor temperature sensor</i> parameter.</p> <p>Input for the floor temperature.</p> <p>Telegram value:     -273...670760 °C</p>			
<b>Input: Cooling ceiling, valve</b>	<b>Room</b>	<b>1 bit DPT 1.001 1 byte DPT 5.001</b>	<b>C, W, T, U</b>
<p>Input for the position (control value) of the cooling ceiling valve.</p> <p>The data point type for the group object is dependent on the settings in the module:</p> <ul style="list-style-type: none"> <li>• If the <i>On/Off</i> option is selected for the <a href="#">Cooling ceiling</a> parameter: DPT 1.001 Telegram value 0 = Off, 1 = On</li> <li>• If the <i>0...100 %</i> option is selected for the <a href="#">Cooling ceiling</a> parameter: DPT 5.001 Telegram value 0...100 %</li> </ul>			
<b>Input: Cooling ceiling, dew point alarm sensor</b>	<b>Room</b>	<b>2 bytes DPT 9.001</b>	<b>C, W, T, U</b>
<p>The module has this group object if the <i>On/Off</i> option or the <i>0...100 %</i> option is selected for the <a href="#">Cooling ceiling</a> parameter and the <i>Yes</i> option is selected for the <i>Cooling ceiling, dew point alarm sensor</i> parameter.</p> <p>Input for the signal value from the dew point sensor in the cooling ceiling.</p> <p>Telegram value:     -273...670760 °C</p>			
<b>Input: Split unit, On/Off</b>	<b>Room</b>	<b>1 bit DPT 1.001</b>	<b>C, W, T, U</b>
<p>The module has this group object if the <i>Yes</i> option is selected for the <a href="#">Split unit</a> parameter.</p> <p>Input for the operating status of the split unit.</p> <p>Telegram value:     0 = Off                       1 = On</p>			



# ABB i-bus<sup>®</sup> KNX Parameters

Object function	Name (can be changed separately)	Data type	Flags
<b>Input: Split unit, fan speed</b>	<b>Room</b>	<b>1 byte DPT 5.001</b>	<b>C, W, T, U</b>
<p>The module has this group object if the Yes option is selected for the <a href="#">Split unit</a> parameter.</p> <p>Input for the fan speed in the split unit.</p> <p>Telegram value: 0...100%</p>			
<b>Input: Split unit, status</b>	<b>Room</b>	<b>1 byte DPT 20.105</b>	<b>C, W, T, U</b>
<p>The module has this group object if the Yes option is selected for the <a href="#">Split unit</a> parameter.</p> <p>Input for the status of the split unit.</p> <p>Telegram value:</p> <ul style="list-style-type: none"> <li>0 = Auto</li> <li>1 = Heat</li> <li>2 = Morning Warmup</li> <li>3 = Cool</li> <li>4 = Night Purge</li> <li>5 = Precool</li> <li>6 = Off</li> <li>7 = Test</li> <li>8 = Emergency Heat</li> <li>9 = Fan only</li> <li>0A = Free Cool</li> <li>0B = Ice</li> <li>0C = Maximum Heat Mode</li> <li>0D = Economic Heat/Cool Mode</li> <li>0E = Dehumidification</li> <li>0F = Calibration Mode</li> <li>10 = Emergency Cool Mode</li> <li>11 = Emergency Steam Mode</li> <li>14 = No Dem</li> </ul>			

# ABB i-bus® KNX Parameters

## 7.7.5

### BACnet objects

Type	Object name	Object type	Unit	COV send condition
Output	Room: Actual room temperature	Analog value	°C (62)	1.0
Output	Room: Room setpoint temperature	Analog value	°C (62)	1.0
Output	Room: Controller On/Off	Binary value	-	-
Output	Room: Heating/cooling operating type	Binary value	-	-
Output	Room: Operating mode	Positive integer value	No unit (95)	1.0
Output	Room: Operating mode override (slave)	Positive integer value	No unit (95)	1.0
Output	Room: Window status	Binary value	-	-
Output	Room: Presence (slave)	Binary value	-	-
Output	Room: Rel. humidity value	Analog value	% (98)	1.0
Output	Room: CO2 value	Analog value	ppm (96)	1.0
Output	Room: Fan coil unit, valve heating	Analog value	% (98)	1.0
Output	Room: Fan coil unit, valve cooling	Analog value	% (98)	1.0
Output	Room: Fan coil unit, valve	Analog value	% (98)	1.0
Output	Room: Fan coil unit, fan speed	Analog value	% (98)	1.0
Output	Room: Fan coil unit, fan manual	Binary value	-	-
Output	Room: Fan coil unit, additional-stage heating	Binary value	-	-
Output	Room: Fan coil unit, fresh air damper	Binary value	-	-
Output	Room: Fan coil unit, dew point sensor	Binary value	-	-
Output	Room: Fan coil unit, level sensor	Binary value	-	-
Output	Room: Radiator, valve	Binary value	-	-
Output	Room: Radiator, valve	Analog value	% (98)	1.0
Output	Room: Floor heating, valve	Binary value	-	-
Output	Room: Floor heating, valve	Analog value	% (98)	1.0
Output	Room: Floor temperature sensor	Analog value	°C (62)	1.0
Output	Room: Cooling ceiling, valve	Binary value	-	-
Output	Room: Cooling ceiling, valve	Analog value	% (98)	1.0
Output	Room: Cooling ceiling, dew point alarm sensor	Binary value	-	-
Output	Room: Split unit, On/Off	Binary value	-	-
Output	Room: Split unit, fan speed	Analog value	% (98)	1.0
Output	Room: Split unit, status	Positive integer value	No unit (95)	1.0

### BACnet input objects

None

# ABB i-bus<sup>®</sup> KNX Parameters

## BACnet output objects

Object name	Object type	Unit	COV send condition
<b>Room: Actual room temperature</b>	<b>Analog value</b>	<b>°C (62)</b>	<b>1.0</b>
Outputs the actual room temperature. Signal value: -273...670760 °C			
<b>Room: Room setpoint temperature</b>	<b>Analog value</b>	<b>°C (62)</b>	<b>1.0</b>
Outputs the current room setpoint temperature. Signal value: -273...670760 °C			
<b>Room: Controller On/Off</b>	<b>Binary value</b>	-	-
The module has this BACnet output object if the <i>Display</i> or <i>Display+set (slave)</i> option is selected for the <a href="#">Controller On/Off</a> parameter. Outputs whether the room thermostat is switched on or off. Signal value: 0 = Off 1 = On			
<b>Room: Heating/cooling operating type</b>	<b>Binary value</b>	-	-
The module has this BACnet output object if any option except <i>None</i> is selected for the <a href="#">Heating/cooling operating type</a> parameter. Outputs the current heating/cooling operating type. Signal value: 0 = Cooling 1 = Heating			
<b>Room: Operating mode</b>	<b>Positive integer value</b>	<b>No unit (95)</b>	<b>1.0</b>
The module has this BACnet output object if any option except <i>None</i> is selected for the <a href="#">Operating mode</a> parameter. Outputs the current HVAC operating mode. Signal value: 0 = Auto 1 = Comfort 2 = Standby 3 = Economy 4 = Building Protection			

# ABB i-bus<sup>®</sup> KNX Parameters

Object name	Object type	Unit	COV send condition
<b>Room: Operating mode override (slave)</b>	<b>Positive integer value</b>	<b>No unit (95)</b>	<b>1.0</b>
<p>The module has this BACnet output object if the <i>Display+set (slave)</i> option is selected for the <a href="#">Operating mode</a> parameter.</p> <p>Outputs the current overridden HVAC operating mode that can be overridden by a higher operating mode.</p> <p>Signal value:      0 = Auto                                1 = Comfort                                2 = Standby                                3 = Economy                                4 = Building Protection</p>			
<b>Room: Window status</b>	<b>Binary value</b>	-	-
<p>The module has this BACnet output object if the <i>Yes</i> option is selected for the <a href="#">Window status</a> parameter.</p> <p>Outputs the window status.</p> <p>Signal value:      0 = Closed                                1 = Open</p>			
<b>Room: Presence (slave)</b>	<b>Binary value</b>	-	-
<p>The module has this BACnet output object if the <i>Yes</i> option is selected for the <a href="#">Presence detector</a> parameter.</p> <p>Outputs the presence status.</p> <p>Signal value:      0 = Not occupied                                1 = Occupied</p>			
<b>Room: Rel. humidity value</b>	<b>Analog value</b>	<b>% (98)</b>	<b>1.0</b>
<p>The module has this BACnet output object if the <i>Yes</i> option is selected for the <a href="#">Rel. humidity</a> parameter.</p> <p>Outputs the relative humidity.</p> <p>Signal value:      0...100%</p>			

# ABB i-bus<sup>®</sup> KNX Parameters

Object name	Object type	Unit	COV send condition
<b>Room: CO2 value</b>	<b>Analog value</b>	<b>ppm (96)</b>	<b>1.0</b>
<p>The module has this BACnet output object if the Yes option is selected for the <a href="#">CO2 value</a> parameter.</p> <p>Outputs the air quality (CO<sub>2</sub>)</p> <p>Signal value: 0...670760</p>			
<b>Room: Fan coil unit, valve heating</b>	<b>Analog value</b>	<b>% (98)</b>	<b>1.0</b>
<p>The module has this BACnet output object if the <i>2-pipe heating</i> option or the <i>4-pipe heating + cooling</i> option is selected for the <a href="#">Fan coil unit</a> parameter.</p> <p>Outputs the valve position (control value) on the fan coil unit for heating.</p> <p>Signal value: 0...100%</p>			
<b>Room: Fan coil unit, valve cooling</b>	<b>Analog value</b>	<b>% (98)</b>	<b>1.0</b>
<p>The module has this BACnet output object if the <i>2-pipe cooling</i> option or the <i>4-pipe heating + cooling</i> option is selected for the <a href="#">Fan coil unit</a> parameter.</p> <p>Outputs the valve position (control value) on the fan coil unit for cooling.</p> <p>Signal value: 0...100%</p>			
<b>Room: Fan coil unit, valve</b>	<b>Analog value</b>	<b>% (98)</b>	<b>1.0</b>
<p>The module has this BACnet output object if the <i>2-pipe heating/cooling</i> option is selected for the <a href="#">Fan coil unit</a> parameter.</p> <p>Outputs the valve position (control value) on the fan coil unit. This is for either heating or cooling depending on the heating/cooling operating type.</p> <p>Signal value: 0...100%</p>			
<b>Room: Fan coil unit, fan speed</b>	<b>Analog value</b>	<b>% (98)</b>	<b>1.0</b>
<p>The module has this BACnet output object if any option except <i>None</i> is selected for the <a href="#">Fan coil unit</a> parameter.</p> <p>Outputs the current fan speed.</p> <p>Signal value: 0...100%</p>			

# ABB i-bus<sup>®</sup> KNX Parameters

Object name	Object type	Unit	COV send condition
<b>Room: Fan coil unit, fan manual</b>	<b>Binary value</b>	-	-
<p>The module has this BACnet output object if any option except <i>None</i> is selected for the <a href="#">Fan coil unit</a> parameter.</p> <p>Outputs whether the current fan speed has been adjusted manually by a user or it was calculated automatically by the room thermostat.</p> <p>Signal value:      0 = Automatic                          1 = Manual</p>			
<b>Room: Fan coil unit, additional-stage heating</b>	<b>Binary value</b> <b>Analog value</b>	- % (98)	- 1.0
<p>Outputs the status of the additional-stage heating</p> <p>The object type for the object is dependent on the settings in the module:</p> <ul style="list-style-type: none"> <li>• If any option except <i>None</i> is selected for the <a href="#">Fan coil unit</a> parameter and the <i>On/Off</i> option is selected for the <a href="#">Fan coil unit, additional-stage heating</a> parameter: Object type binary value Unit – Send condition – Signal value 0 = Off, 1 = On</li> <li>• If any option except <i>None</i> is selected for the <a href="#">Fan coil unit</a> parameter and the <i>0...100 %</i> option is selected for the <a href="#">Fan coil unit, additional-stage heating</a> parameter: Object type analog value Unit % (98) Send condition 1.0 Signal value 0...100 %</li> </ul>			
<b>Room: Fan coil unit, fresh air damper</b>	<b>Binary value</b> <b>Analog value</b>	- % (98)	- 1.0
<p>Outputs the position of the fresh air damper.</p> <p>The object type for the object is dependent on the settings in the module:</p> <ul style="list-style-type: none"> <li>• If any option except <i>None</i> is selected for the <a href="#">Fan coil unit</a> parameter and the <i>Open/Closed</i> option is selected for the <a href="#">Fan coil unit, fresh air damper</a> parameter: Object type binary value Unit – Send condition – Signal value 0 = Closed, 1 = Open</li> <li>• If any option except <i>None</i> is selected for the <a href="#">Fan coil unit</a> parameter and the <i>0...100 %</i> option is selected for the <a href="#">Fan coil unit, fresh air damper</a> parameter: Object type analog value Unit % (98) Send condition 1.0 Signal value 0...100 %</li> </ul>			

# ABB i-bus<sup>®</sup> KNX Parameters

Object name	Object type	Unit	COV send condition
<b>Room: Fan coil unit, dew point sensor</b>	<b>Binary value</b>	-	-
<p>The module has this BACnet output object if any option except <i>None</i> is selected for the <a href="#">Fan coil unit</a> parameter and the <i>Yes</i> option is selected for the <i>Fan coil unit, dew point sensor</i> parameter.</p> <p>Outputs the signal value from the dew point sensor in the fan coil unit.</p> <p>Signal value:     0 = Off                     1 = On</p>			
<b>Fan coil unit, level sensor</b>	<b>Binary value</b>	-	-
<p>The module has this BACnet output object if any option except <i>None</i> is selected for the <a href="#">Fan coil unit</a> parameter and the <i>Yes</i> option is selected for the <i>Fan coil unit, level sensor</i> parameter.</p> <p>Outputs the signal value from the level sensor in the fan coil unit.</p> <p>Signal value:     0 = Off                     1 = On</p>			
<b>Room: Radiator, valve</b>	<b>Binary value</b> <b>Analog value</b>	- % (98)	- 1.0
<p>Outputs the position of the radiator valve.</p> <p>The object type for the object is dependent on the settings in the module:</p> <ul style="list-style-type: none"> <li>• If the <i>On/Off</i> option is selected for the <a href="#">Radiator</a> parameter: <ul style="list-style-type: none"> <li>Object type binary value</li> <li>Unit –</li> <li>Send condition –</li> <li>Signal value 0 = Off, 1 = On</li> </ul> </li> <li>• If the <i>0...100 %</i> option is selected for the <a href="#">Radiator</a> parameter: <ul style="list-style-type: none"> <li>Object type analog value</li> <li>Unit % (98)</li> <li>Send condition 1.0</li> <li>Signal value 0...100 %</li> </ul> </li> </ul>			

# ABB i-bus<sup>®</sup> KNX Parameters

Object name	Object type	Unit	COV send condition
<b>Room: Floor heating, valve</b>	<b>Binary value</b> <b>Analog value</b>	- % (98)	- <b>1.0</b>
<p>Outputs the position of the floor heating valve.</p> <p>The object type for the object is dependent on the settings in the module:</p> <ul style="list-style-type: none"> <li>If the <i>On/Off</i> option is selected for the <a href="#">Floor heating</a> parameter: Object type binary value Unit – Send condition – Signal value 0 = Off, 1 = On</li> <li>If the <i>0...100 %</i> option is selected for the <a href="#">Floor heating</a> parameter: Object type analog value Unit % (98) Send condition 1.0 Signal value 0...100 %</li> </ul>			
<b>Room: Floor temperature sensor</b>	<b>Analog value</b>	<b>°C (62)</b>	<b>1.0</b>
<p>The module has this BACnet output object if the <i>On/Off</i> option or the <i>0...100 %</i> option is selected for the <a href="#">Floor heating</a> parameter and the <i>Yes</i> option is selected for the <a href="#">Floor temperature sensor</a> parameter.</p> <p>Outputs the floor temperature.</p> <p>Signal value:       -273...670760 °C</p>			
<b>Room: Cooling ceiling, valve</b>	<b>Binary value</b> <b>Analog value</b>	- % (98)	- <b>1.0</b>
<p>Outputs the position of the cooling ceiling valve.</p> <p>The object type for the object is dependent on the settings in the module:</p> <ul style="list-style-type: none"> <li>If the <i>On/Off</i> option is selected for the <a href="#">Cooling ceiling</a> parameter: Object type binary value Unit – Send condition – Signal value 0 = Off, 1 = On</li> <li>If the <i>0...100 %</i> option is selected for the <a href="#">Cooling ceiling</a> parameter: Object type analog value Unit % (98) Send condition 1.0 Signal value 0...100 %</li> </ul>			



# ABB i-bus<sup>®</sup> KNX Parameters

Object name	Object type	Unit	COV send condition
<b>Room: Cooling ceiling, dew point alarm sensor</b>	<b>Binary value</b>	-	-
<p>The module has this BACnet output object if the <i>On/Off</i> option or the <i>0...100 %</i> option is selected for the <a href="#">Cooling ceiling</a> parameter and the <i>Yes</i> option is selected for the <i>Cooling ceiling, dew point alarm sensor</i> parameter.</p> <p>Outputs the signal value from the dew point sensor in the cooling ceiling.</p> <p>Signal value:     -273...670760 °C</p>			
<b>Room: Split unit, On/Off</b>	<b>Binary value</b>	-	-
<p>The module has this BACnet output object if the <i>Yes</i> option is selected for the <a href="#">Split unit</a> parameter.</p> <p>Outputs the operating status of the split unit.</p> <p>Signal value:     0 = Off                   1 = On</p>			
<b>Room: Split unit, fan speed</b>	<b>Analog value</b>	<b>% (98)</b>	<b>1.0</b>
<p>Outputs the fan speed in the split unit.</p> <p>The module has this BACnet output object if the <i>Yes</i> option is selected for the <a href="#">Split unit</a> parameter.</p> <p>Signal value:     0...100 %</p>			

# ABB i-bus® KNX Parameters

Object name	Object type	Unit	COV send condition
<b>Room: Split unit, status</b>	<b>Positive integer value</b>	<b>No unit (95)</b>	<b>1.0</b>
<p>Outputs the status of the split unit.</p> <p>The module has this BACnet output object if the Yes option is selected for the <a href="#">Split unit</a> parameter.</p> <p>Signal value:</p> <ul style="list-style-type: none"> <li>0 = Auto</li> <li>1 = Heat</li> <li>2 = Morning Warmup</li> <li>3 = Cool</li> <li>4 = Night Purge</li> <li>5 = Precool</li> <li>6 = Off</li> <li>7 = Test</li> <li>8 = Emergency Heat</li> <li>9 = Fan only</li> <li>0A = Free Cool</li> <li>0B = Ice</li> <li>0C = Maximum Heat Mode</li> <li>0D = Economic Heat/Cool Mode</li> <li>0E = Dehumidification</li> <li>0F = Calibration Mode</li> <li>10 = Emergency Cool Mode</li> <li>11 = Emergency Steam Mode</li> <li>14 = No Dem</li> </ul>			

# ABB i-bus<sup>®</sup> KNX Parameters

7.7.6

WebUI

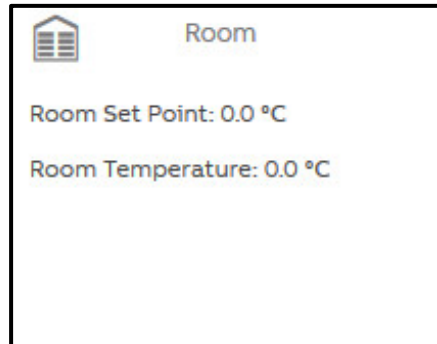

Open the detailed view of the ASM by clicking the ASM's tile.

# ABB i-bus® KNX Parameters

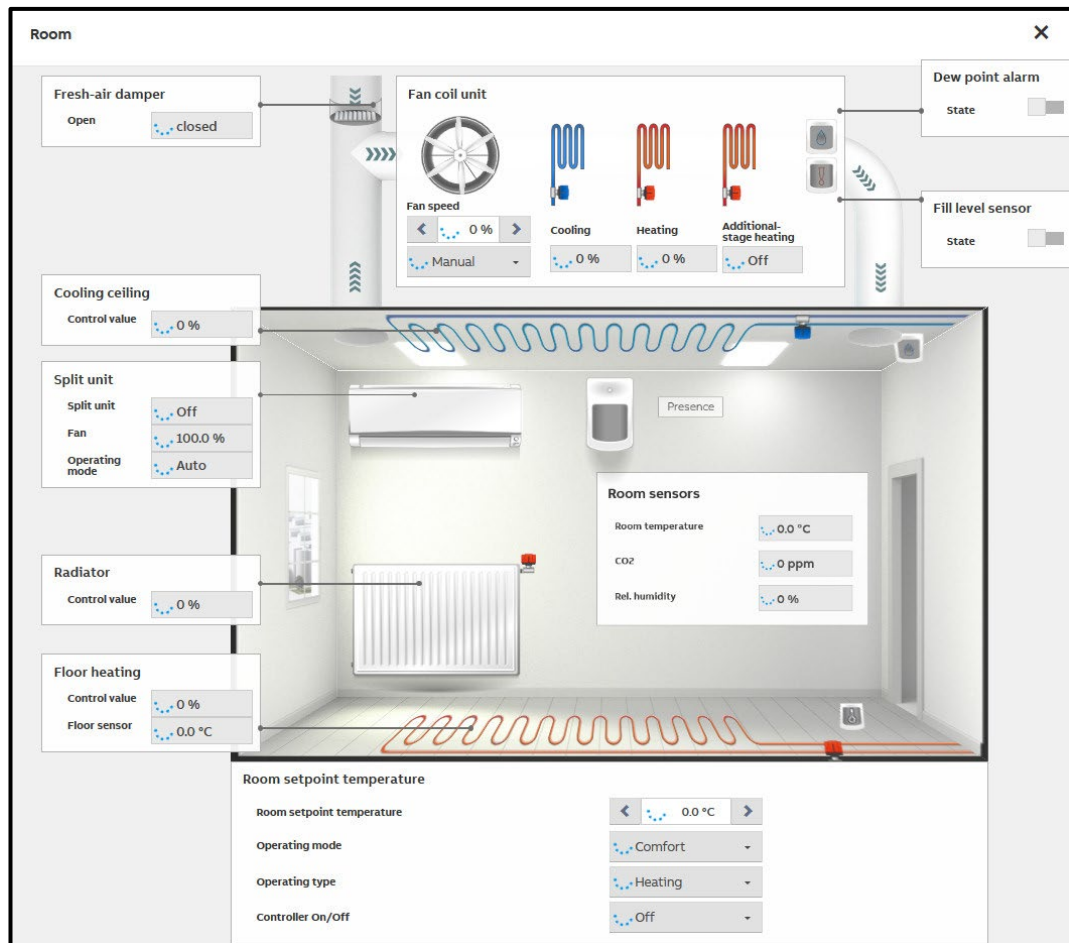

The web user interface for the module displays the HVAC systems in the room and their status based on the settings in the module. Systems and functions not activated are hidden. If activated in the settings for the module, all users except the "Viewer" can operate the systems via the web user interface and, e.g., change the room setpoint temperature or override a valve.

If values are changed, the new value is only displayed once the KNX room thermostat linked has updated this value. Depending on the layout and load on the KNX system, there may be a short delay.

# ABB i-bus<sup>®</sup> KNX Parameters

## 7.8 Room setpoint temperatures ASM

### 7.8.1 General

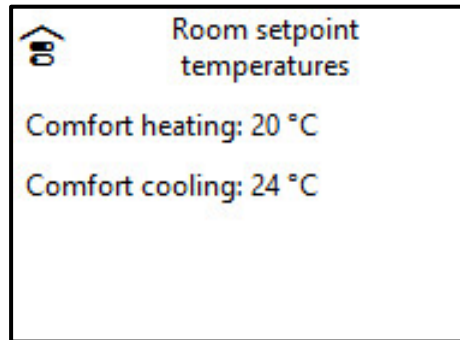

With this application-specific automation module (ASM), room setpoint temperatures for the various room operating modes (Comfort, Standby, Economy and Building Protection) can be set centrally for several rooms via the web user interface. The application controller outputs the room setpoint temperatures set on the KNX bus, on the ASM output socket and on BACnet. If the values are linked to several controllers at the same time, these values can apply to several rooms.

The operating modes for which the setpoint temperatures can be set via the web user interface can be changed in the parameters for the module.

The module has a validation function so that invalid setpoint combinations cannot be set via the web user interface. For information on validation, see [Initial values](#) and [WebUI](#).

# ABB i-bus<sup>®</sup> KNX Parameters

7.8.2

## Settings

General	
Name	Room setpoint temperatures
Description	
Reinstall	<input type="checkbox"/>
Interfaces	
Cooling Building Protection	<input checked="" type="checkbox"/>
Cooling Economy	<input checked="" type="checkbox"/>
Cooling Standby	<input checked="" type="checkbox"/>
Cooling Comfort	<input checked="" type="checkbox"/>
Heating Comfort	<input checked="" type="checkbox"/>
Heating Standby	<input checked="" type="checkbox"/>
Heating Economy	<input checked="" type="checkbox"/>
Heating Building Protection	<input checked="" type="checkbox"/>
Dead band between heating and cool...	3.0 <input type="text"/> °C
Send cyclically values to KNX every	06:00:00 <input type="text"/>
Initial values	
Cooling Building Protection	40.0 <input type="text"/> °C
Cooling Economy	27.0 <input type="text"/> °C
Cooling Standby	25.0 <input type="text"/> °C
Cooling Comfort	24.0 <input type="text"/> °C
Heating Comfort	20.0 <input type="text"/> °C
Heating Standby	19.0 <input type="text"/> °C
Heating Economy	17.0 <input type="text"/> °C
Heating Building Protection	3.0 <input type="text"/> °C

### General

You will find descriptions of the global settings (Name, Description, Reinstall, BACnet, WebUI) in [chapter 7.3. Global ASM settings](#).

# ABB i-bus<sup>®</sup> KNX Parameters

## **Interfaces**

The operating modes necessary for the application can be selected in the following by selecting the checkboxes. For each operating mode activated

- An adjustable room setpoint temperature is displayed on the web user interface
- An initial room setpoint temperature is displayed in the *Initial values* parameter window
- An ASM output socket is displayed
- A group object is displayed
- A BACnet object is displayed

## **Cooling Building Protection**

Options:           No (checkbox cleared)  
                      Yes (checkbox selected)

## **Cooling Economy**

Options:           No (checkbox cleared)  
                      Yes (checkbox selected)

## **Cooling Standby**

Options:           No (checkbox cleared)  
                      Yes (checkbox selected)

## **Cooling Comfort**

Options:           No (checkbox cleared)  
                      Yes (checkbox selected)

## **Heating Comfort**

Options:           No (checkbox cleared)  
                      Yes (checkbox selected)

## **Heating Standby**

Options:           No (checkbox cleared)  
                      Yes (checkbox selected)

## **Heating Economy**

Options:           No (checkbox cleared)  
                      Yes (checkbox selected)

## **Heating Building Protection**

Options:           No (checkbox cleared)  
                      Yes (checkbox selected)

# ABB i-bus<sup>®</sup> KNX

## Parameters

### **Dead band between heating and cooling**

Options: 0...3...10 °C (calculated dynamically)

Using the dead band, a minimum spacing between the room setpoint temperatures can be set for heating and cooling. This value is defined in °C and applies between all room setpoint temperatures for heating and cooling, independent of the operating modes. Using this dead band it can be ensured that a controller does not change continuously between heating and cooling.

If only heating or only cooling is activated, this setting has no effect. If the dead zone is set to 0 °C, this function is deactivated.

The dead zone cannot be set via the web user interface.

### **Send cyclically values to KNX every**

Options: 00:10:00...06:00:00...23:59:00 [hh:mm:ss]

The room setpoint temperatures are sent immediately on the KNX bus after every change on the web user interface. In addition, using this setting all room setpoint temperatures activated can be sent again cyclically on the KNX bus. The cycle time is restarted each time a value change is sent.

It is not possible to deactivate the cyclic sending.



# ABB i-bus<sup>®</sup> KNX

## Parameters

### **Initial values**

Here the initial room setpoint temperatures are set for the related operating modes that are active in the application controller after downloading the ASM. The previous values are restored after a device restart.

There are only settings for the operating modes for which the checkbox is selected in the *Interfaces* parameter.

The room setpoint temperatures can be set in the range from 0 °C - 50 °C. A validation process checks whether the following sequence is maintained:

4. Cooling Building Protection
5. Cooling Economy
6. Cooling Standby
7. Cooling Comfort
8. Dead band
9. Heating Comfort
10. Heating Standby
11. Heating Economy
12. Heating Building Protection

Every room setpoint temperature must equal to or greater than the previous. Furthermore, the dead band set must be respected. Otherwise the incorrect fields are marked with a red frame.

### **Cooling Building Protection**

Options: 0...40...50 °C

### **Cooling Economy**

Options: 0...27...50 °C

### **Cooling Standby**

Options: 0...25...50 °C

### **Cooling Comfort**

Options: 0...20...50 °C

### **Heating Comfort**

Options: 0...20...50 °C

### **Heating Standby**

Options: 0...19...50 °C

### **Heating Economy**

Options: 0...17...50 °C

### **Heating Building Protection**

Options: 0...3...50 °C

# ABB i-bus® KNX Parameters

## 7.8.3

### Sockets

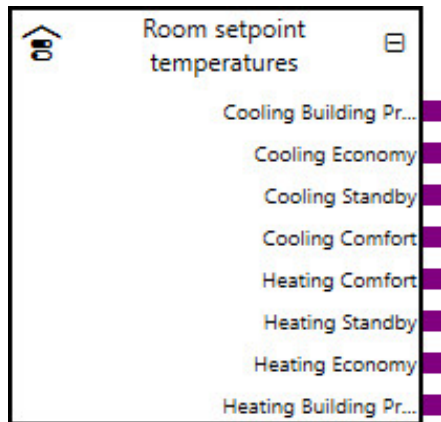

The ASM output sockets are dependent on the operating modes selected in the *Interfaces* parameter; outputs only appear for those operating modes for which the checkbox in the *Interfaces* parameter has not been cleared.

Overview of the ASM sockets for linking to other modules:

Type	Object name	Data type
Output	Cooling Building Protection	9.001
Output	Cooling Economy	9.001
Output	Cooling Standby	9.001
Output	Cooling Comfort	9.001
Output	Heating Comfort	9.001
Output	Heating Standby	9.001
Output	Heating Economy	9.001
Output	Heating Building Protection	9.001

#### Input sockets

None

# ABB i-bus<sup>®</sup> KNX Parameters

## Output sockets

Object name	Data type
<b>Cooling Building Protection</b>	<b>DPT 9.001</b>
The module has this output socket if the Yes option is selected for the <a href="#">Cooling Building Protection</a> parameter.	
Signal value: 0...50 °C	
<b>Cooling Economy</b>	<b>DPT 9.001</b>
The module has this output socket if the Yes option is selected for the <a href="#">Cooling Economy</a> parameter.	
Signal value: 0...50 °C	
<b>Cooling Standby</b>	<b>DPT 9.001</b>
The module has this output socket if the Yes option is selected for the <a href="#">Cooling Standby</a> parameter.	
Signal value: 0...50 °C	
<b>Cooling Comfort</b>	<b>DPT 9.001</b>
The module has this output socket if the Yes option is selected for the <a href="#">Cooling Comfort</a> parameter.	
Signal value: 0...50 °C	
<b>Heating Comfort</b>	<b>DPT 9.001</b>
The module has this output socket if the Yes option is selected for the <a href="#">Heating Comfort</a> parameter.	
Signal value: 0...50 °C	
<b>Heating Standby</b>	<b>DPT 9.001</b>
The module has this output socket if the Yes option is selected for the <a href="#">Heating Standby</a> parameter.	
Signal value: 0...50 °C	
<b>Heating Economy</b>	<b>DPT 9.001</b>
The module has this output socket if the Yes option is selected for the <a href="#">Heating Economy</a> parameter.	
Signal value: 0...50 °C	
<b>Heating Building Protection</b>	<b>DPT 9.001</b>
The module has this output socket if the Yes option is selected for the <a href="#">Heating Building Protection</a> parameter.	
Signal value: 0...50 °C	

# ABB i-bus<sup>®</sup> KNX Parameters

## 7.8.4

### Group objects

Object function	Name (can be changed separately)	Data point type (DPT)	Length	Flags					
				C	R	W	T	U	I
Output: Cooling Building Protection	Room setpoint temperatures	9.001	2 bytes	x	x		x		
Output: Cooling Economy	Room setpoint temperatures	9.001	2 bytes	x	x		x		
Output: Cooling Standby	Room setpoint temperatures	9.001	2 bytes	x	x		x		
Output: Cooling Comfort	Room setpoint temperatures	9.001	2 bytes	x	x		x		
Output: Heating Comfort	Room setpoint temperatures	9.001	2 bytes	x	x		x		
Output: Heating Standby	Room setpoint temperatures	9.001	2 bytes	x	x		x		
Output: Heating Economy	Room setpoint temperatures	9.001	2 bytes	x	x		x		
Output: Heating Building Protection	Room setpoint temperatures	9.001	2 bytes	x	x		x		

Object function	Name (can be changed separately)	Data type	Flags
<b>Output: Cooling Building Protection</b>	<b>Room setpoint temperatures</b>	<b>2 bytes DPT 9.001</b>	<b>C, R, T</b>
The module has this output group object if the Yes option is selected for the <a href="#">Cooling Building Protection</a> parameter.			
Telegram value: 0...50 °C			
<b>Output: Cooling Economy</b>	<b>Room setpoint temperatures</b>	<b>2 bytes DPT 9.001</b>	<b>C, R, T</b>
The module has this output group object if the Yes option is selected for the <a href="#">Cooling Economy</a> parameter.			
Telegram value: 0...50 °C			
<b>Output: Cooling Standby</b>	<b>Room setpoint temperatures</b>	<b>2 bytes DPT 9.001</b>	<b>C, R, T</b>
The module has this output group object if the Yes option is selected for the <a href="#">Cooling Standby</a> parameter.			
Telegram value: 0...50 °C			
<b>Output: Cooling Comfort</b>	<b>Room setpoint temperatures</b>	<b>2 bytes DPT 9.001</b>	<b>C, R, T</b>
The module has this output group object if the Yes option is selected for the <a href="#">Cooling Comfort</a> parameter.			
Telegram value: 0...50 °C			

# ABB i-bus<sup>®</sup> KNX Parameters

Object function	Name (can be changed separately)	Data type	Flags
<b>Output: Heating Comfort</b>	<b>Room setpoint temperatures</b>	<b>2 bytes DPT 9.001</b>	<b>C, R, T</b>
The module has this output group object if the Yes option is selected for the <a href="#">Heating Comfort</a> parameter.			
Telegram value: 0...50 °C			
<b>Output: Heating Standby</b>	<b>Room setpoint temperatures</b>	<b>2 bytes DPT 9.001</b>	<b>C, R, T</b>
The module has this output group object if the Yes option is selected for the <a href="#">Heating Standby</a> parameter.			
Telegram value: 0...50 °C			
<b>Output: Heating Economy</b>	<b>Room setpoint temperatures</b>	<b>2 bytes DPT 9.001</b>	<b>C, R, T</b>
The module has this output group object if the Yes option is selected for the <a href="#">Heating Economy</a> parameter.			
Telegram value: 0...50 °C			
<b>Output: Heating Building Protection</b>	<b>Room setpoint temperatures</b>	<b>2 bytes DPT 9.001</b>	<b>C, R, T</b>
The module has this output group object if the Yes option is selected for the <a href="#">Heating Building Protection</a> parameter.			
Telegram value: 0...50 °C			

# ABB i-bus<sup>®</sup> KNX Parameters

## 7.8.5

### BACnet objects

Type	BACnet name	Object type	Unit	COV send condition
Output	Room setpoint temperatures: Cooling Comfort	Analog value	°C (62)	1.0
Output	Room setpoint temperatures: Cooling Economy	Analog value	°C (62)	1.0
Output	Room setpoint temperatures: Cooling Building Protection	Analog value	°C (62)	1.0
Output	Room setpoint temperatures: Cooling Standby	Analog value	°C (62)	1.0
Output	Room setpoint temperatures: Heating Comfort	Analog value	°C (62)	1.0
Output	Room setpoint temperatures: Heating Economy	Analog value	°C (62)	1.0
Output	Room setpoint temperatures: Heating Building Protection	Analog value	°C (62)	1.0
Output	Room setpoint temperatures: Heating Standby	Analog value	°C (62)	1.0

### BACnet input objects

None

# ABB i-bus<sup>®</sup> KNX Parameters

## **BACnet output objects**

Object name	Object type	Unit	COV send condition
<b>Room setpoint temperatures: Cooling Comfort</b>	<b>Analog value</b>	<b>°C (62)</b>	<b>1.0</b>
The module has this BACnet output object if the Yes option is selected for the <a href="#">Cooling Comfort</a> parameter.			
Signal value: 0...50 °C			
<b>Room setpoint temperatures: Cooling Economy</b>	<b>Analog value</b>	<b>°C (62)</b>	<b>1.0</b>
The module has this BACnet output object if the Yes option is selected for the <a href="#">Cooling Economy</a> parameter.			
Signal value: 0...50 °C			
<b>Room setpoint temperatures: Cooling Building Protection</b>	<b>Analog value</b>	<b>°C (62)</b>	<b>1.0</b>
The module has this BACnet output object if the Yes option is selected for the <a href="#">Cooling Building Protection</a> parameter.			
Signal value: 0...50 °C			
<b>Room setpoint temperatures: Cooling Standby</b>	<b>Analog value</b>	<b>°C (62)</b>	<b>1.0</b>
The module has this BACnet output object if the Yes option is selected for the <a href="#">Cooling Standby</a> parameter.			
Signal value: 0...50 °C			
<b>Room setpoint temperatures: Heating Comfort</b>	<b>Analog value</b>	<b>°C (62)</b>	<b>1.0</b>
The module has this BACnet output object if the Yes option is selected for the <a href="#">Heating Comfort</a> parameter.			
Signal value: 0...50 °C			
<b>Room setpoint temperatures: Heating Economy</b>	<b>Analog value</b>	<b>°C (62)</b>	<b>1.0</b>
The module has this BACnet output object if the Yes option is selected for the <a href="#">Heating Economy</a> parameter.			
Signal value: 0...50 °C			
<b>Room setpoint temperatures: Heating Building Protection</b>	<b>Analog value</b>	<b>°C (62)</b>	<b>1.0</b>
The module has this BACnet output object if the Yes option is selected for the <a href="#">Heating Building Protection</a> parameter.			
Signal value: 0...50 °C			
<b>Room setpoint temperatures: Heating Standby</b>	<b>Analog value</b>	<b>°C (62)</b>	<b>1.0</b>
The module has this BACnet output object if the Yes option is selected for the <a href="#">Heating Standby</a> parameter.			
Signal value: 0...50 °C			

# ABB i-bus<sup>®</sup> KNX Parameters

7.8.6

WebUI

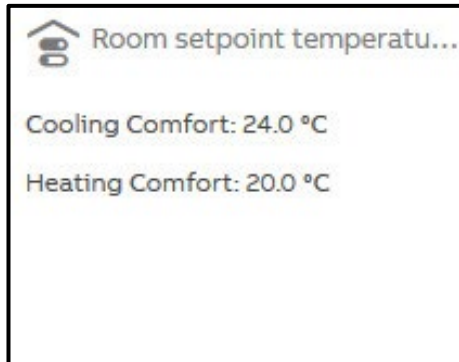

Open the detailed view of the ASM by clicking the ASM's tile.

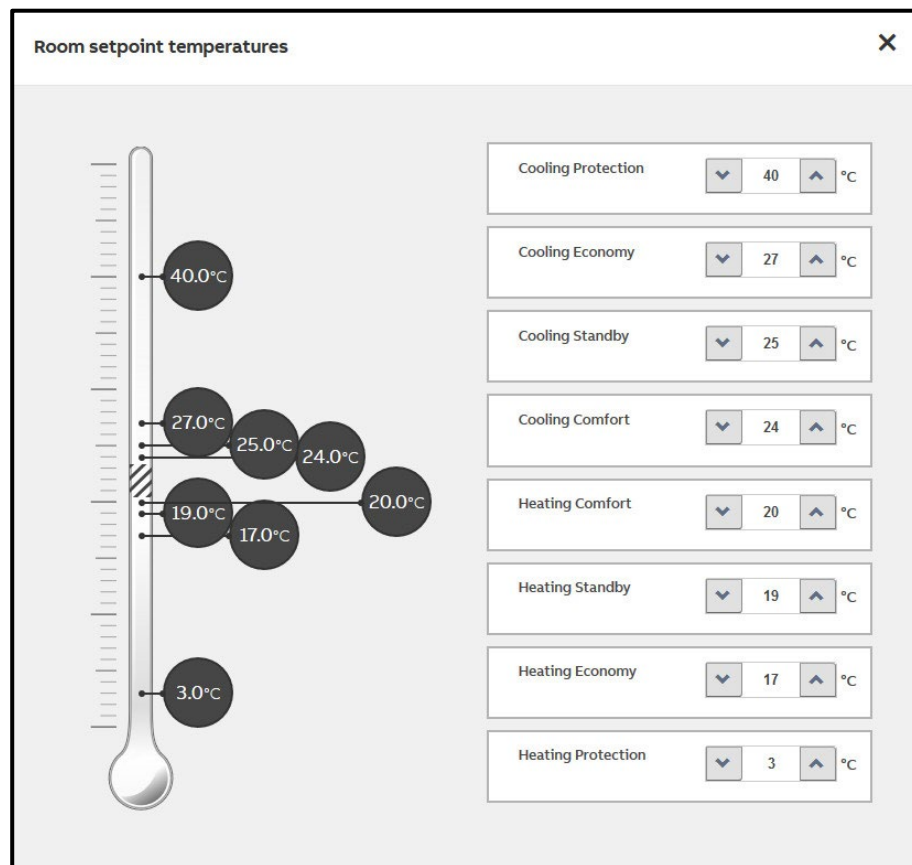



# ABB i-bus<sup>®</sup> KNX

## Parameters

All room setpoint temperatures for the operating modes activated are displayed on the web user interface. Change the related room setpoint temperatures using the ▲ and ▼ buttons or using the keyboard. All users with the exception of the "Viewer" have the right to change these values.

The room setpoint temperatures can be set in the range from 0 °C – 50 °C. A validation process makes sure only the following sequence can be set:

1. Cooling Building Protection
2. Cooling Economy
3. Cooling Standby
4. Cooling Comfort
5. Dead band
6. Heating Comfort
7. Heating Standby
8. Heating Economy
9. Heating Building Protection

Every room setpoint temperature must equal to or greater than the previous. Furthermore, the dead band set must be respected.

# ABB i-bus® KNX Parameters

## 7.9 Heating distribution circuit ASM

### 7.9.1 General

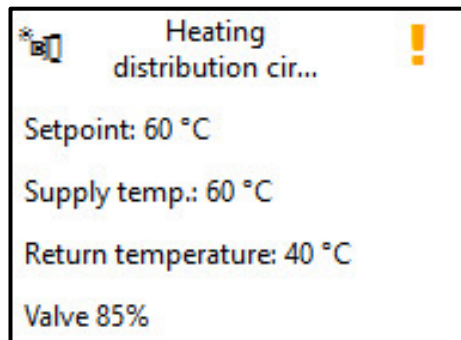

This application-specific automation module (ASM) calculates the supply setpoint temperature and sends the value calculated to a heating distribution circuit controller (heating circuit controller). The module also permits the display and operation, via the module's web user interface, of the heating distribution circuit controller linked via KNX.

# ABB i-bus<sup>®</sup> KNX Parameters

7.9.2

## Settings

General	
Name	Heating distribution circuit
Description	
Reinstall	<input type="checkbox"/>
Supply setpoint temperature	
Supply temperature control	<input checked="" type="checkbox"/>
Supply setpoint temperature source	Calculated weather compe... ▼
Calculation formula	Heating curve ▼
Nominal outside temperature	-14 ▲▼ °C
Nominal room temperature	20 ▲▼ °C
Nominal supply temperature	80 ▲▼ °C
Nominal return temperature	60 ▲▼ °C
Max. supply temperature	80 ▲▼ °C
Radiator exponent	Radiators to DIN 4703 (1.30) ▼
Start supply temperature curve at...	19 ▲▼ °C
Economy mode	Disabled ▼
Room involvement	<input type="checkbox"/>
Switch off if no room demand	<input type="checkbox"/>
Enable heating distribution circuit...	<input type="checkbox"/>
Pump	
Double pump	<input type="checkbox"/>
Override by WebUI	<input type="checkbox"/>
Pump display operating status	<input type="checkbox"/>
Pump display pump fault status	<input type="checkbox"/>
Display pump repair switch status	<input type="checkbox"/>
Valve	
Valve type	3-way valve (mixing valve) ▼
Status Valve purge	<input type="checkbox"/>
Valve override disable/enable	<input type="checkbox"/>

### General

You will find descriptions of the global settings (Name, Description, Reinstall, BACnet, WebUI) in [chapter 7.3, Global ASM settings](#).

# ABB i-bus<sup>®</sup> KNX Parameters

## **Supply setpoint temperature**

In this parameter window it is specified how the supply setpoint temperature for the heating distribution circuit is calculated.

## **Supply temperature control**

Options:            No (checkbox cleared)  
                      Yes (checkbox selected)

On the selection of the Yes option, the ASM calculates the supply setpoint temperature for the heating distribution circuit and sends the value calculated to the heating distribution circuit controller via the group object. Other parameters define how the calculation is undertaken.

Selection of Yes option:

Dependent parameter(s):

### **Supply setpoint temperature source**

Options:            ASM input socket  
                      WebUI Input  
                      BACnet input object  
                      Calculated weather compensated

This parameter determines how the supply setpoint temperature is determined for the heating distribution circuit. This setpoint is sent to the heating distribution circuit controller via the group object.

- *ASM input socket*: The supply setpoint temperature received via the input socket on the ASM is used. This is an ASM multiple socket on which the highest value present is used.
- *WebUI Input*: The supply setpoint temperature is set on the web user interface for the ASM.
- *BACnet input object*: The supply setpoint temperature received via the BACnet object for the ASM is used.
- *Calculated weather compensated*: The module calculates the supply setpoint temperature currently required based on the outside temperature.

# ABB i-bus<sup>®</sup> KNX Parameters

Selection of *ASM input socket* or *BACnet input object* option:

Dependent parameter(s):

### **Supply setpoint temperature offset**

Options:        0...100 °C

An offset can be entered to compensate for the energy losses in the pipes. This value is always added to the supply setpoint temperature and is limited by the *Max. supply temperature* parameter.

Selection of *WebUI Input* or *BACnet input object* option:

Dependent parameter(s):

### **Initial values**

### **Supply setpoint temperature**

Options:        0...80...100 °C

This parameter defines the supply setpoint temperature that is output after downloading the module. This value is output until a new value is entered on the web user interface or is written to the BACnet object. This value is limited by the *Max. supply temperature* parameter.

# ABB i-bus<sup>®</sup> KNX Parameters

Selection of *Calculated weather compensated* option:

Dependent parameter(s):

**Calculation formula**

Options:        Heating curve  
                  Custom

This parameter specifies the method used to determine the currently required supply setpoint temperature based on the outside temperature. The relationship between the outside temperature and the supply temperature is depicted by a curve.

- *Heating curve*: A heating curve based on the nominal values (design values) for the heating is calculated. These nominal values stem from the basic planning for the heating system and are based on the design point. The heating curve can be seen on the web user interface for the module. The values for the curve cannot be changed directly.
- *Custom*: The shape of the curve can be set as required by entering the points.

Selection of *Heating curve* option:

Dependent parameter(s):

**Nominal outside temperature**

Options:        -100...-14...100 °C

The outside temperature at the design point is specified using this parameter. This is normally the lowest outside temperature for which the heating system is designed. This information is used to calculate the heating curve.

**Nominal room temperature**

Options:        0...20...100 °C

The room temperature at the design point is specified using this parameter. This value is used to calculate the heating curve and has no relationship to the actual room setpoint temperature used.

# ABB i-bus<sup>®</sup> KNX Parameters

## **Nominal supply temperature**

Options: 0...80...100 °C

The supply temperature at the design point is specified using this parameter. This is normally the highest supply temperature for the heating system that is set at the lowest outside temperature. This information is used to calculate the heating curve.

## **Nominal return temperature**

Options: 0...60...100 °C

The theoretical return temperature at the design point is specified using this parameter. This information provides the spread between the supply and return temperature. This information is used to calculate the heating curve.

## **Max. supply temperature**

Options: 0...80...100 °C

The supply setpoint temperature output by the module is limited using this parameter. This is a safety function that ensures a supply setpoint temperature too high for the heating system is not output under any circumstances. For example, the supply setpoint temperature for floor heating can be limited to maximum 35 °C.

# ABB i-bus<sup>®</sup> KNX Parameters

## **Radiator exponent**

Options:      None/Linear (1.0)  
                  Floor heating (1.05)  
                  Floor heating (1.10)  
                  Flat radiators (1.20)  
                  Flat radiators (1.25)  
                  Radiator to DIN 4703 (1.30)  
                  Flat radiators (1.33)  
                  Convectors (1.35)  
                  Convectors (1.40)  
                  Convectors (1.45)  
                  Convectors (1.50)

The radiator exponent is dependent on the type and design of the heating element and is normally stated by the manufacturer. The radiator exponent describes the relationship between the increasing supply temperature and the non-proportionally increasing heat dissipation into the room.

This information is used to calculate the heating curve. The higher this value is, the more curved the heating curve is.

## **Start supply temperature curve at outside temperature**

Options:      -100...19...100 °C

The outside temperature at which heating is started is specified using this parameter. This value is the start of the heating curve. The heating limit is dependent on the insulation standards in the building and can be selected lower, the better the building is insulated.



# ABB i-bus<sup>®</sup> KNX Parameters

## Economy mode

Options:     Disabled  
              Based on Scheduler  
              Based on the current room setpoint temperatures

The heating curve, and therefore the supply setpoint temperature, is as standard only a theoretical value that is exclusively dependent on the outside temperature.

This parameter specifies that, in addition to the theoretical nominal room setpoint temperature, the actual room setpoint temperature flows into the calculation and the calculated heating curve is correspondingly lowered in times with low room setpoint temperatures. The term "nighttime reduction" is also used. In this way during times with low heat demand in the rooms, the heat provided is reduced to lower the losses and therefore save energy.

- *Disabled*: The heating curve is static and based only on the parameterized nominal room temperature. There is no dynamic lowering of the heating curve.
- *Based on Scheduler*: The heating curve is adjusted dynamically based on a scheduler. The scheduler switches between the operating modes and the related room setpoint temperatures. A heating curve is displayed for each operating mode and the mode activated is marked on the web user interface for the module. An ASM input socket for connecting an operating mode scheduler is displayed on activating this function. Which operating modes are used can be set using the parameters that follow. An ASM input socket is also displayed for each of these operating modes activated; the related room setpoint temperature is passed to the module using this input socket.
- *Based on the current room setpoint temperatures*: The heating curve is adjusted dynamically based on the room setpoint temperatures currently active in the rooms. An ASM input socket configured for the selection of the maximum is displayed on activating this function. All room setpoint temperatures for the heating circuit are connected to this object; the module selects the highest room setpoint temperature as the basis for the calculation.

# ABB i-bus<sup>®</sup> KNX Parameters

Selection of *Based on Scheduler* option:

Dependent parameter(s):

### **Scheduler operating mode Standby**

Options:        No (checkbox cleared)  
                  Yes (checkbox selected)

The "Standby" operating mode is activated using this parameter and a corresponding ASM input socket displayed.

### **Scheduler operating mode Economy**

Options:        No (checkbox cleared)  
                  Yes (checkbox selected)

The "Economy" operating mode is activated using this parameter and a corresponding ASM input socket displayed.

### **Scheduler operating mode Building Protection**

Options:        No (checkbox cleared)  
                  Yes (checkbox selected)

The "Building Protection" operating mode is activated using this parameter and a corresponding ASM input socket displayed.

# ABB i-bus<sup>®</sup> KNX Parameters

Selection of *Custom* option:

Dependent parameter(s):

## Custom supply temperature curve

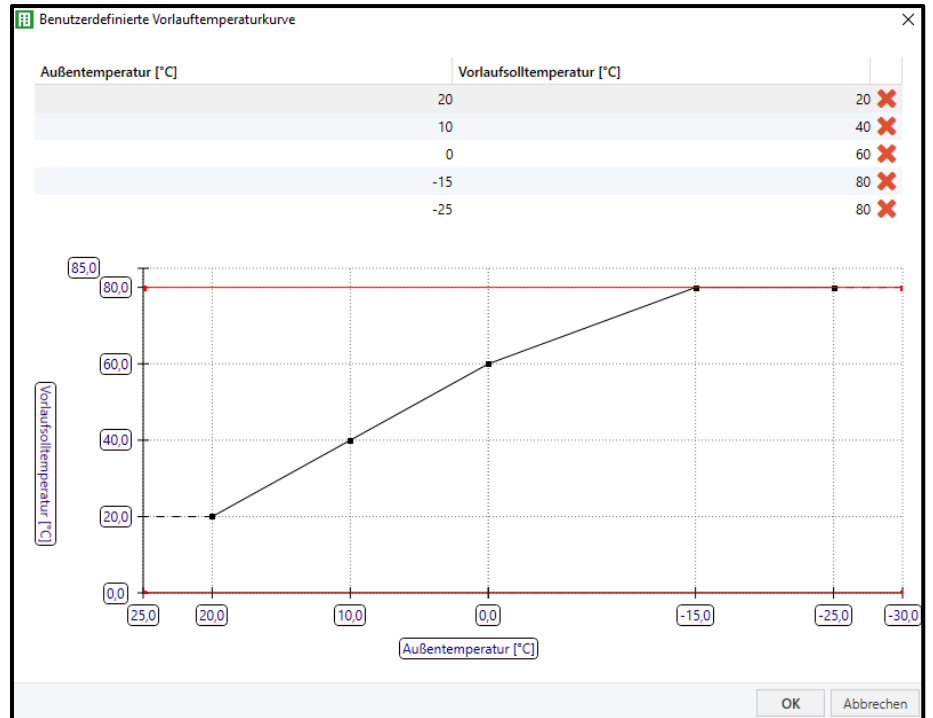

After you click the "Edit" button, a window opens where you can add a custom supply temperature curve by changing the supply setpoint temperature. The shape of the curve can be set as required by entering the points. The limit specified via the *Max. supply temperature* parameter is displayed on the chart as a red line.

This curve is used after downloading the module and can be modified via the web user interface for the module.

## Room involvement

Options: No (checkbox cleared)  
Yes (checkbox selected)

The heating curve, and therefore the supply setpoint temperature, is as standard only a theoretical value that is exclusively dependent on the outside temperature.

By activating the "Economy mode" function the room setpoint temperatures can also flow into the calculation; however the actual heat demand from the rooms connected to the heating distribution circuit is not taken into account. Along with the outside temperature, the actual heat demand is dependent on the sunlight, wind speed and internal heat loads such as people, electrical equipment and lighting.

With room involvement, the heating curve can be raised and lowered dynamically based on the actual room demand.

The advantage here is that at any time the optimum supply setpoint for the heating system is used. In this way during times with low heat demand in the rooms, the heat provided is reduced to lower the losses and therefore save energy. On the other hand, in times with increased heat demand from the rooms, the amount of heat provided is increased. In this way the required comfort temperature is reached more quickly in the rooms.

The current heat demand from the rooms is determined by evaluating the control values from the room thermostats (e.g. radiator valve position). For this purpose an input socket is displayed to link the control values. The module determines the highest value from the control values linked.

Based on the parameters that follow, the module raises or lowers the heating curve and therefore the supply setpoint temperature over a longer period until the optimum control value is reached. Here the highest control value is always taken as the reference. If the control value leaves the optimum value, the adaptation starts again from the beginning.

The current adaptation of the heating curve is displayed on the web user interface for the module. The calculation takes place every 5 minutes.

# ABB i-bus<sup>®</sup> KNX Parameters

Prerequisites for the correct function of room involvement:

- All control values from the room valves in the heating distribution circuit are available and connected to the ASM input socket. There must therefore not be any conventional thermostats in the heating distribution circuit.
- The heating distribution circuit has been balanced hydraulically.
- The following parameters for the room involvement function have been optimized. For this purpose the complete heating system normally needs to be observed and optimized over several weeks.

Selection of Yes option:

Dependent parameter(s)

### **Increase supply temperature**

Options: 0...10...100 K

This parameter specifies the maximum value up to which the supply setpoint temperature is allowed to be increased by the "Room involvement" function. This increase relates to the value specified by the heating curve. A value of 0 K deactivates the increase by the room involvement.

### **Decrease supply temperature**

Options: -100...-10...0 K

This parameter specifies the minimum value up to which the supply setpoint temperature is allowed to be reduced by the "Room involvement" function. This reduction relates to the value specified by the heating curve. A value of 0 K deactivates the reduction by the room involvement.

## **Optimum room control value**

Options: 10...70...90 %

The *Room involvement* function increases and reduces the supply setpoint temperature until the highest of the room control values linked to the ASM input socket reaches this optimum value.

## **Controller proportional factor Xp**

Options: 10...30...90 %

Proportional range of the P controller used for the room involvement. The smaller the value set, the faster the control reacts. However, the value should not be selected too small because otherwise there may be a risk of overshoot.

Example:

The value Xp = 30 % means: If the highest control value on the ASM input socket is 30 % below the *Optimum room control value*, the supply temperature increases by the full value of *Increase supply temperature*.

## **Room involvement calculation delay**

Options: 00:00:00...00.45.00...23:59:00 hh:mm:ss

This parameter delays the calculation of the room involvement (and therefore the increase/reduction of the supply temperature) after starting the device so that the heating system can reach a steady state.

# ABB i-bus<sup>®</sup> KNX Parameters

## **Switch off if no room demand**

Options:           No (checkbox cleared)  
                      Yes (checkbox selected)

With this function the module monitors the room control values and automatically switches on and off the heating distribution circuit controller connected accordingly.

It is a prerequisite for this function that all control values from the room valves in the heating distribution circuit are available and connected to the ASM input socket. There must therefore not be any conventional thermostats in the heating distribution circuit.

This function is affected by the [Enable heating distribution circuit control based on ASM input socket](#) function. If both functions are activated, the *Enable heating distribution circuit control based on ASM input socket* has a higher priority.

Selection of Yes option:

Dependent parameter(s)

### **Switch on if the room demand is higher than**

Options:           0...10...100 %

The module sends a switch-on command to the heating distribution circuit controller if the highest room control value present on the ASM input socket exceeds this value.

### **Switch off if the room demand is equal to or less than**

Options:           0...100 %

The module sends a switch-off command to the heating distribution circuit controller if the highest room control value present on the ASM input socket is the same as or less than this value.

# ABB i-bus<sup>®</sup> KNX Parameters

## Enable heating distribution circuit control based on ASM input socket

Options: No (checkbox cleared)  
Yes (checkbox selected)

If this function is activated, an additional ASM input object for the control (Off/On) is activated; the value of this object is forwarded to the heating distribution circuit controller via a group object that is then displayed.

If the [Switch off if no room demand](#) function is also activated, there is the following relationship:

<b>ASM input socket Control On/Off Heating/cooling distribution circuit controller control</b>	<b>Result of the Switch off if no room demand function</b>	<b>Result and output in the Control On/Off group object</b>
Off	Switched off	Off
On	Switched off	On
Off	Switched on	Off
On	Switched on	On



# ABB i-bus<sup>®</sup> KNX Parameters

## **Pump**

Settings for the heating distribution circuit's pump.

## **Double pump**

Options:            No (checkbox cleared)  
                      Yes (checkbox selected)

This parameter specifies whether a double pump or a single pump is used in the heating distribution circuit. The group objects, BACnet objects, ASM sockets and the depiction on the web user interface are adjusted to suit the setting.

## **Override by WebUI**

Options:            No (checkbox cleared)  
                      Yes (checkbox selected)

If this function is activated, the pump can be overridden via the web user interface. For this purpose additional group objects are displayed that must be connected to the heating distribution circuit controller.

## **Pump display operating status**

Options:            No (checkbox cleared)  
                      Yes (checkbox selected)

If the pump outputs its operating status (Off/On), this status can be received by a group object via this function and output on the web user interface, in a BACnet object and on the ASM socket.

# ABB i-bus<sup>®</sup> KNX

## Parameters

### **Pump display pump fault status**

Options:            No (checkbox cleared)  
                      Yes (checkbox selected)

If the pump outputs its fault status, this status can be received by a group object via this function and output on the web user interface, in a BACnet object and on the ASM socket. The ASM only displays this state, there are no switching actions based on the fault status.

### **Display pump repair switch status**

Options:            No (checkbox cleared)  
                      Yes (checkbox selected)

If the pump has a repair switch and the contact position is output, this status can be received by a group object via this function and output on the web user interface, in a BACnet object and on the ASM socket.

# ABB i-bus<sup>®</sup> KNX Parameters

## **Valve**

Settings for the heating distribution circuit's valve.

### **Valve type**

Options:            3-way valve (mixing valve)  
                         2-way valve  
                         None

Setting for the valve type used in the heating distribution circuit. This parameter affects the depiction on the web user interface.

Selection of *3-way valve (mixing valve)* or *2-way valve* option:

Dependent parameter(s)

### **Status Valve purge**

Options:            No (checkbox cleared)  
                         Yes (checkbox selected)

If this function is activated, the status of the valve purge can be received by a group object and output on the web user interface, in a BACnet object and on the ASM socket.

### **Valve override disable/enable**

Options:            No (checkbox cleared)  
                         Yes (checkbox selected)

If this function is activated, the valve can be overridden via the web user interface. For this purpose additional group objects are displayed that must be connected to the heating distribution circuit controller.

# ABB i-bus® KNX Parameters

## 7.9.3

### Sockets

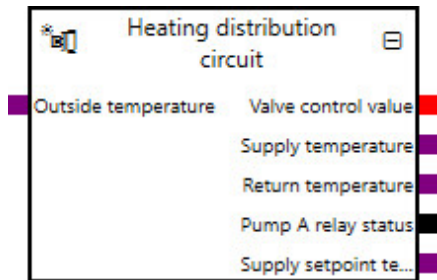

Overview of the ASM sockets for linking to other modules:

Type	Object name	Data type
Input	Control On/Off Heating/cooling distribution circuit controller control	1.001
Input	Supply setpoint temperature External specification	9.001
Input	Outside temperature	9.001
Input	Room setpoint temperature Comfort	9.001
Input	Room setpoint temperature Standby	9.001
Input	Room setpoint temperature Economy	9.001
Input	Room setpoint temperature Building Protection	9.001
Input	Room control values	5.001
Input	Room setpoint temperature	9.001
Input	Operating mode	20.102
Output	Valve control value	5.001
Output	Supply temperature	9.001
Output	Return temperature	9.001
Output	Control On/Off	1.001
Output	Valve override disable/enable	1.003
Output	Valve override control value	5.001
Output	Status Valve purge	1.011
Output	Pump A operating status (Off/On)	1.011
Output	Pump A relay status	1.001
Output	Pump A fault	1.005
Output	Pump A repair switch status	1.011
Output	Pump A override disable/enable	1.003
Output	Pump A override value	1.001
Output	Pump B operating status (Off/On)	1.011
Output	Pump B relay status	1.001
Output	Pump B fault	1.005
Output	Pump B repair switch status	1.011
Output	Pump B override disable/enable	1.003
Output	Pump B override value	1.001
Output	Supply setpoint temperature	9.001
Output	Supply setpoint temperature External specification	9.001
Output	Room involvement	9.002
Output	Max. room setpoint temperature	9.001

# ABB i-bus<sup>®</sup> KNX Parameters

## Input sockets

Object name	Data type
<b>Control On/Off Heating/cooling distribution circuit controller control</b>	<b>DPT 1.001</b>
<p>This module has this input socket if the Yes option is selected for the <a href="#">Supply temperature control</a> parameter and the Yes option is selected for the <a href="#">Enable heating distribution circuit control based on ASM input socket</a> parameter.</p> <p>The heating distribution circuit controller's control connected can be switched on and off by another module via this input. This is a multiple input socket on which the input signals are linked via an OR operator.</p> <p>Signal value:        0 = Off                           1 = On</p>	
<b>Supply setpoint temperature External specification</b>	<b>DPT 9.001</b>
<p>This module has this input socket if the Yes option is selected for the <a href="#">Supply temperature control</a> parameter and the <i>ASM input socket</i> option is selected for the <a href="#">Supply setpoint temperature source</a> parameter.</p> <p>Specification of the supply setpoint temperature by another module. This value is output in the corresponding group objects to the heating distribution circuit controller linked.</p> <div style="background-color: #f0f0f0; padding: 5px;"> <p> <b>Note</b></p> <p>The value can be affected by the <i>Max. supply temperature</i> and <i>Supply setpoint temperature offset</i> parameters in the module.</p> </div> <p>Signal value:        -273...670760 °C</p>	
<b>Outside temperature</b>	<b>DPT 9.001</b>
<p>This module has this input socket if the Yes option is selected for the <a href="#">Supply temperature control</a> parameter and the <i>Calculated weather compensated</i> option is selected for the <a href="#">Supply setpoint temperature source</a> parameter.</p> <p>Input for the outside temperature. The supply setpoint temperature is calculated by the module from the heating curve based on this value.</p> <p>Signal value:        -273...670760 °C</p>	

# ABB i-bus<sup>®</sup> KNX Parameters

Object name	Data type
<b>Room setpoint temperature Comfort</b>	<b>DPT 9.001</b>
<p>This module has this input socket if the Yes option is selected for the <a href="#">Supply temperature control</a> parameter, the <i>Calculated weather compensated</i> option is selected for the <a href="#">Supply setpoint temperature source</a> parameter and the <i>Based on Scheduler</i> option is selected for the <a href="#">Economy mode</a> parameter.</p> <p>Input for the room setpoint temperature in the Comfort operating mode for the heating operating type for the rooms connected to the heating distribution circuit. The module selects the highest value and uses this value for the <i>Economy mode</i> function to adjust the heating curve and therefore the supply setpoint temperature to the current needs.</p> <p>Signal value:            -273...670760 °C</p>	
<b>Room setpoint temperature Standby</b>	<b>DPT 9.001</b>
<p>This module has this input socket if the Yes option is selected for the <a href="#">Supply temperature control</a> parameter, the <i>Calculated weather compensated</i> option is selected for the <a href="#">Supply setpoint temperature source</a> parameter, the <i>Based on Scheduler</i> option is selected for the <a href="#">Economy mode</a> parameter and the Yes option is selected for the <i>Scheduler operating mode Standby</i> parameter.</p> <p>Input for the room setpoint temperature in the Standby operating mode for the heating operating type for the rooms connected to the heating distribution circuit. The module selects the highest value and uses this value for the <i>Economy mode</i> function to adjust the heating curve and therefore the supply setpoint temperature to the current needs.</p> <p>Signal value:            -273...670760 °C</p>	
<b>Room setpoint temperature Economy</b>	<b>DPT 9.001</b>
<p>This module has this input socket if the Yes option is selected for the <a href="#">Supply temperature control</a> parameter, the <i>Calculated weather compensated</i> option is selected for the <a href="#">Supply setpoint temperature source</a> parameter, the <i>Based on Scheduler</i> option is selected for the <a href="#">Economy mode</a> parameter and the Yes option is selected for the <i>Scheduler operating mode Economy</i> parameter.</p> <p>Input for the room setpoint temperature in the Economy operating mode for the heating operating type for the rooms connected to the heating distribution circuit. The module selects the highest value and uses this value for the <i>Economy mode</i> function to adjust the heating curve and therefore the supply setpoint temperature to the current needs.</p> <p>Signal value:            -273...670760 °C</p>	
<b>Room setpoint temperature Building Protection</b>	<b>DPT 9.001</b>
<p>This module has this input socket if the Yes option is selected for the <a href="#">Supply temperature control</a> parameter, the <i>Calculated weather compensated</i> option is selected for the <a href="#">Supply setpoint temperature source</a> parameter, the <i>Based on Scheduler</i> option is selected for the <a href="#">Economy mode</a> parameter and the Yes option is selected for the <i>Scheduler operating mode Building Protection</i> parameter.</p> <p>Input for the room setpoint temperature in the Building Protection operating mode for the heating operating type for the rooms connected to the heating distribution circuit. The module selects the highest value and uses this value for the <i>Economy mode</i> function to adjust the heating curve and therefore the supply setpoint temperature to the current needs.</p> <p>Signal value:            -273...670760 °C</p>	

# ABB i-bus<sup>®</sup> KNX Parameters

Object name	Data type
<b>Room control values</b>	<b>DPT 5.001</b>
<p>The module has this input socket in the following conditions:</p> <ul style="list-style-type: none"> <li>• If the Yes option is selected for the <a href="#">Supply temperature control</a> parameter, the <i>Calculated weather compensated</i> option is selected for the <a href="#">Supply setpoint temperature source</a> parameter and the Yes option is selected for the <a href="#">Room involvement</a> parameter.</li> <li>• If the Yes option is selected for the <a href="#">Switch off if no room demand</a> parameter.</li> </ul> <p>Input for the "heating" control values (valve positions) for all rooms connected to the heating distribution circuit. The module selects the highest value and uses this value for the <i>Room involvement</i> and <i>Switch off if no room demand</i> functions to adjust the heating curve and therefore the supply setpoint temperature to the current needs.</p> <p>Signal value: 0...100%</p>	
<b>Room setpoint temperature</b>	<b>DPT 9.001</b>
<p>This module has this input socket if the Yes option is selected for the <a href="#">Supply temperature control</a> parameter, the <i>Calculated weather compensated</i> option is selected for the <a href="#">Supply setpoint temperature source</a> parameter and the <i>Based on the current room setpoint temperatures</i> option is selected for the <a href="#">Economy mode</a> parameter.</p> <p>Input for the current "heating" room setpoint temperatures for all rooms connected to the heating distribution circuit. The module selects the highest value and uses this value for the <i>Economy mode</i> function to adjust the heating curve and therefore the supply setpoint temperature to the current needs.</p> <p>Signal value: -273...670760 °C</p>	
<b>Operating mode</b>	<b>DPT 20.102</b>
<p>This module has this input socket if the Yes option is selected for the <a href="#">Supply temperature control</a> parameter, the <i>Calculated weather compensated</i> option is selected for the <a href="#">Supply setpoint temperature source</a> parameter and the <i>Based on Scheduler</i> option is selected for the <a href="#">Economy mode</a> parameter.</p> <p>Input for the current "heating" operating mode for the rooms connected to the heating distribution circuit. The module uses this value for the <i>Economy mode</i> function to adjust the heating curve and therefore the supply setpoint temperature to the current needs.</p> <p>Signal value:</p> <ul style="list-style-type: none"> <li>1 = Comfort</li> <li>2 = Standby</li> <li>3 = Economy</li> <li>4 = Building Protection</li> </ul>	

# ABB i-bus<sup>®</sup> KNX Parameters

## Output sockets

Object name	Data type
<b>Valve control value</b>	<b>DPT 5.001</b>
<p>The module has this output socket if the <i>3-way valve (mixing valve)</i> option or the <i>2-way valve</i> option is selected for the <a href="#">Valve type</a> parameter.</p> <p>Outputs the valve control value for the heating distribution circuit. This value is received from the heating distribution circuit controller linked via the related module group object</p> <p>Signal value:           0...100%</p>	
<b>Supply temperature</b>	<b>DPT 9.001</b>
<p>Outputs the current supply temperature that is received via the related group object.</p> <p>Signal value:           -273...670760 °C</p>	
<b>Return temperature</b>	<b>DPT 9.001</b>
<p>Outputs the current return temperature that is received via the related group object.</p> <p>Signal value:           -273...670760 °C</p>	
<b>Control On/Off</b>	<b>DPT 1.001</b>
<p>The module has this output socket in the following conditions:</p> <ul style="list-style-type: none"> <li>• If the Yes option is selected for the <a href="#">Supply temperature control</a> parameter and the Yes option is selected for the <a href="#">Enable heating distribution circuit control based on ASM input socket</a> parameter.</li> <li>• If the Yes option is selected for the <a href="#">Switch off if no room demand</a> parameter.</li> </ul> <p>Outputs the status of the control that is sent to the heating distribution circuit controller via the related group object. The state is dependent on the <a href="#">Enable heating distribution circuit control based on ASM input socket</a> and <a href="#">Switch off if no room demand</a> parameters.</p> <p>Signal value:           0 = Off                               1 = On</p>	



# ABB i-bus<sup>®</sup> KNX Parameters

Object name	Data type
<b>Valve override disable/enable</b>	<b>DPT 1.003</b>
<p>The module has this output socket if the 3-way valve (<i>mixing valve</i>) option or the 2-way valve option is selected for the <a href="#">Valve type</a> parameter and the Yes option is selected for the <a href="#">Valve override disable/enable</a> parameter.</p> <p>Outputs whether the override of the heating distribution circuit's valve is active or inactive.</p> <p>Signal value:        0 = Disabled                           1 = Enabled</p>	
<b>Valve override control value</b>	<b>DPT 5.001</b>
<p>The module has this output socket if the 3-way valve (<i>mixing valve</i>) option or the 2-way valve option is selected for the <a href="#">Valve type</a> parameter and the Yes option is selected for the <a href="#">Valve override disable/enable</a> parameter.</p> <p>Outputs the value used to override the heating distribution circuit's valve if the override is active</p> <p>Signal value:        0...100 %</p>	
<b>Status Valve purge</b>	<b>DPT 1.011</b>
<p>The module has this output socket if the 3-way valve (<i>mixing valve</i>) option or the 2-way valve option is selected for the <a href="#">Valve type</a> parameter and the Yes option is selected for the <a href="#">Status Valve purge</a> parameter.</p> <p>Outputs the status as to whether the heating distribution circuit controller is actually undertaking a valve purge. This value is received from the heating distribution circuit controller linked via the related module group object.</p> <p>Signal value:        0 = Inactive                           1 = Active</p>	
<b>Pump A operating status (Off/On)</b>	<b>DPT 1.011</b>
<p>The module has this output socket if the Yes option is selected for the <a href="#">Pump display operating status</a> parameter.</p> <p>Outputs the operating status (Off/On) provided by the pump. On pumps with their own control, this operating status can differ from the operating status of the heating distribution circuit controller.</p> <p>Signal value:        0 = Inactive                           1 = Active</p>	
<b>Pump A relay status</b>	<b>DPT 1.001</b>
<p>Outputs the status of the pump from the heating distribution circuit controller.</p> <p>Signal value:        0 = Off                           1 = On</p>	

# ABB i-bus<sup>®</sup> KNX Parameters

Object name	Data type
<b>Pump A fault</b>	<b>DPT 1.005</b>
<p>The module has this output socket if the Yes option is selected for the <a href="#">Pump display pump fault status</a> parameter.</p> <p>Outputs the fault status provided by the pump.</p> <p>Signal value:        0 = No alarm                           1 = Alarm</p>	
<b>Pump A repair switch status</b>	<b>DPT 1.011</b>
<p>The module has this output socket if the Yes option is selected for the <a href="#">Display pump repair switch status</a> parameter.</p> <p>Outputs the contact position provided by the pump repair switch.</p> <p>Signal value:        0 = Inactive                           1 = Active</p>	
<b>Pump A override disable/enable</b>	<b>DPT 1.003</b>
<p>The module has this output socket if the Yes option is selected for the <a href="#">Override by WebUI</a> parameter.</p> <p>Outputs whether the heating distribution circuit's pump is overridden.</p> <p>Signal value:        0 = Disabled                           1 = Enabled</p>	
<b>Pump A override value</b>	<b>DPT 1.001</b>
<p>The module has this output socket if the Yes option is selected for the <a href="#">Override by WebUI</a> parameter.</p> <p>Outputs the state with which the heating distribution circuit's pump is overridden if the pump override is active.</p> <p>Signal value:        0 = Off                           1 = On</p>	

# ABB i-bus<sup>®</sup> KNX Parameters

Object name	Data type
<b>Pump B operating status (Off/On)</b>	<b>DPT 1.011</b>
<p>The module has this output socket if the Yes option is selected for the <a href="#">Double pump</a> parameter and the Yes option is selected for the <a href="#">Pump display operating status</a> parameter.</p> <p>Outputs the operating status (Off/On) provided by the second pump. On pumps with their own control, this operating status can differ from the operating status of the heating distribution circuit controller.</p> <p>.</p> <p>Signal value:        0 = Inactive                           1 = Active</p>	
<b>Pump B relay status</b>	<b>DPT 1.001</b>
<p>The module has this output socket if the Yes option is selected for the <a href="#">Double pump</a> parameter.</p> <p>Outputs the status of the second pump from the heating distribution circuit controller.</p> <p>Signal value:        0 = Off                           1 = On</p>	
<b>Pump B fault</b>	<b>DPT 1.005</b>
<p>The module has this output socket if the Yes option is selected for the <a href="#">Double pump</a> parameter and the Yes option is selected for the <a href="#">Pump display pump fault status</a> parameter.</p> <p>Outputs the fault status provided by the second pump.</p> <p>Signal value:        0 = No alarm                           1 = Alarm</p>	
<b>Pump B repair switch status</b>	<b>DPT 1.011</b>
<p>The module has this output socket if the Yes option is selected for the <a href="#">Double pump</a> parameter and the Yes option is selected for the <a href="#">Display pump repair switch status</a> parameter.</p> <p>Outputs the contact position provided by the second pump repair switch.</p> <p>Signal value:        0 = Inactive                           1 = Active</p>	

# ABB i-bus<sup>®</sup> KNX Parameters

Object name	Data type
<b>Pump B override disable/enable</b>	<b>DPT 1.003</b>
<p>The module has this output socket if the Yes option is selected for the <a href="#">Double pump</a> parameter and the Yes option is selected for the <a href="#">Override by WebUI</a> parameter.</p> <p>Outputs whether the heating distribution circuit's second pump is overridden.</p> <p>Signal value:        0 = Disabled                           1 = Enabled</p>	
<b>Pump B override value</b>	<b>DPT 1.001</b>
<p>The module has this output socket if the Yes option is selected for the <a href="#">Double pump</a> parameter and the Yes option is selected for the <a href="#">Override by WebUI</a> parameter.</p> <p>Outputs the state with which the heating distribution circuit's second pump is overridden if the pump override is active.</p> <p>Signal value:        0 = Off                           1 = On</p>	
<b>Supply setpoint temperature</b>	<b>DPT 9.001</b>
<p>The module has this output socket if the Yes option is selected for the <a href="#">Supply temperature control</a> parameter.</p> <p>Outputs the current supply setpoint temperature as is sent by the module to the heating distribution circuit controller via the related group object. The supply setpoint temperature output here is, depending on the setting, either calculated by this module based on the outside temperature, or specified via an ASM input socket or BACnet and also takes into account any possible override of the supply setpoint temperature via the web user interface.</p> <p>Signal value:        -273...670760 °C</p>	
<b>Supply setpoint temperature External specification</b>	<b>DPT 9.001</b>
<p>This module has this output socket if the Yes option is selected for the <a href="#">Supply temperature control</a> parameter and the <i>BACnet input object</i> option is selected for the <a href="#">Supply setpoint temperature source</a> parameter.</p> <p>Outputs the supply setpoint temperature specified via the BACnet object. This status does not take into account any possible override of the supply setpoint temperature via the web user interface.</p> <p>Signal value:        -273...670760 °C</p>	

# ABB i-bus<sup>®</sup> KNX Parameters

Object name	Data type
<b>Room involvement</b>	<b>DPT 9.002</b>
<p>The module has this output socket if the <i>Yes</i> option is selected for the <a href="#">Supply temperature control</a> parameter, the <i>Calculated weather compensated</i> option is selected for the <a href="#">Supply setpoint temperature source</a> parameter and the <i>Yes</i> option is selected for the <a href="#">Room involvement</a> parameter.</p> <p>Outputs of current value by which the supply setpoint temperature is increased or reduced by the <i>Room involvement</i> function.</p> <p>Signal value:           -670760...670760 K</p>	
<b>Max. room setpoint temperature</b>	<b>DPT 9.001</b>
<p>This module has this output socket if the <i>Yes</i> option is selected for the <a href="#">Supply temperature control</a> parameter, the <i>Calculated weather compensated</i> option is selected for the <a href="#">Supply setpoint temperature source</a> parameter and the <i>Based on the current room setpoint temperatures</i> option is selected for the <a href="#">Economy mode</a> parameter.</p> <p>Outputs the highest room setpoint temperature that is present on the ASM input socket and that is used by the <i>Economy mode</i> function.</p> <p>Signal value:           -273...670760 °C</p>	

# ABB i-bus<sup>®</sup> KNX Parameters

## 7.9.4

### Group objects

Object function	Name (can be changed separately)	Data point type (DPT)	Length	Flags						
				C	R	W	T	U	I	
Input: Valve control value	Heating distribution circuit	5.001	1 byte	x		x	x			
Input: Supply temperature	Heating distribution circuit	9.001	2 bytes	x			x	x		
Input: Return temperature	Heating distribution circuit	9.001	2 bytes	x			x	x		
Output: Supply setpoint temperature	Heating distribution circuit	9.001	2 bytes	x	x				x	
Input: Pump A relay status	Heating distribution circuit	1.001	1 bit	x			x	x		
In-/Output: Valve override disable/enable	Heating distribution circuit	1.003	1 bit	x	x		x	x		
In-/Output: Valve override control value	Heating distribution circuit	5.001	1 byte	x	x		x	x		
Input: Status Valve purge	Heating distribution circuit	1.011	1 bit	x			x	x		
Input: Pump A repair switch status	Heating distribution circuit	1.011	1 bit	x			x	x		
Input: Pump A fault	Heating distribution circuit	1.011	1 bit	x			x	x		
Input: Pump A operating status (Off/On)	Heating distribution circuit	1.011	1 bit	x			x	x		
In-/Output: Pump A override disable/enable	Heating distribution circuit	1.003	1 bit	x	x		x	x		
In-/Output: Pump A override value	Heating distribution circuit	1.001	1 bit	x	x		x	x		
Input: Pump B fault	Heating distribution circuit	1.011	1 bit	x			x	x		
In-/Output: Pump B override disable/enable	Heating distribution circuit	1.003	1 bit	x	x		x	x		
In-/Output: Pump B override value	Heating distribution circuit	1.001	1 bit	x	x		x	x		
Input: Pump B repair switch status	Heating distribution circuit	1.011	1 bit	x			x	x		
Input: Pump B operating status (Off/On)	Heating distribution circuit	1.011	1 bit	x			x	x		
Input: Pump B relay status	Heating distribution circuit	1.001	1 bit	x			x	x		
Output: Control On/Off	Heating distribution circuit	1.001	1 bit	x	x				x	

# ABB i-bus<sup>®</sup> KNX Parameters

Object function	Name (can be changed separately)	Data type	Flags
<b>Input: Valve control value</b>	<b>Heating distribution circuit</b>	<b>1 byte DPT 5.001</b>	<b>C, W, T</b>
<p>The module has this group object if the <i>3-way valve (mixing valve)</i> option or the <i>2-way valve</i> option is selected for the <a href="#">Valve type</a> parameter.</p> <p>Input for the valve control value status from the heating distribution circuit.</p> <p>Telegram value: 0...100 %</p>			
<b>Input: Supply temperature</b>	<b>Heating distribution circuit</b>	<b>2 bytes DPT 9.001</b>	<b>C, W, T</b>
<p>Input for supply temperature measured in the heating distribution circuit.</p> <p>Telegram value: -273...670760 °C</p>			
<b>Input: Return temperature</b>	<b>Heating distribution circuit</b>	<b>2 bytes DPT 9.001</b>	<b>C, W, T</b>
<p>Input for return temperature measured in the heating distribution circuit.</p> <p>Telegram value: -273...670760 °C</p>			
<b>Output: Supply setpoint temperature</b>	<b>Heating distribution circuit</b>	<b>2 bytes DPT 9.001</b>	<b>C, R, T</b>
<p>Outputs the supply setpoint temperature calculated by the module as the value specified to the heating distribution circuit controller.</p> <p>Telegram value: -273...670760 °C</p>			
<b>Input: Pump A relay status</b>	<b>Heating distribution circuit</b>	<b>1 bit DPT 1.001</b>	<b>C, W, T</b>
<p>Input for the status of the pump from the heating distribution circuit controller.</p> <p>Telegram value: 0 = Off 1 = On</p>			

# ABB i-bus<sup>®</sup> KNX

## Parameters

Object function	Name (can be changed separately)	Data type	Flags
<b>In-/Output: Valve override disable/enable</b>	<b>Heating distribution circuit</b>	<b>1 bit DPT 1.003</b>	<b>C, R, W, T</b>
<p>The module has this group object if the 3-way valve (<i>mixing valve</i>) option or the 2-way valve option is selected for the <a href="#">Valve type</a> parameter and the Yes option is selected for the <a href="#">Valve override disable/enable</a> parameter.</p> <p>This object activates/deactivates the valve (mixing valve) override for the heating distribution circuit controller.</p> <p>Telegram value:    0 = Disabled                       1 = Enabled</p>			
<b>In-/Output: Valve override control value</b>	<b>Heating distribution circuit</b>	<b>1 byte DPT 5.001</b>	<b>C, R, W, T</b>
<p>The module has this group object if the 3-way valve (<i>mixing valve</i>) option or the 2-way valve option is selected for the <a href="#">Valve type</a> parameter and the Yes option is selected for the <a href="#">Valve override disable/enable</a> parameter.</p> <p>This object specifies the control value (valve position) used to override the valve for the heating distribution circuit if the valve override is active.</p> <p>Telegram value:    0...100 %</p>			
<b>Input: Status Valve purge</b>	<b>Heating distribution circuit</b>	<b>1 bit DPT 1.011</b>	<b>C, W, T</b>
<p>The module has this group object if the 3-way valve (<i>mixing valve</i>) option or the 2-way valve option is selected for the <a href="#">Valve type</a> parameter and the Yes option is selected for the <a href="#">Status Valve purge</a> parameter.</p> <p>Input for the status of the heating distribution circuit controller as to whether a valve purge is currently in progress.</p> <p>Telegram value:    0 = Inactive                       1 = Active</p>			
<b>Input: Pump A repair switch status</b>	<b>Heating distribution circuit</b>	<b>1 bit DPT 1.011</b>	<b>C, W, T</b>
<p>The module has this group object if the Yes option is selected for the <a href="#">Display pump repair switch status</a> parameter.</p> <p>The status of the repair switch for the pump can be received via this group object and evaluated by the device.</p> <p>Telegram value:    0 = Inactive                       1 = Active</p>			



# ABB i-bus<sup>®</sup> KNX Parameters

Object function	Name (can be changed separately)	Data type	Flags
<b>Input: Pump A fault</b>	<b>Heating distribution circuit</b>	<b>1 bit DPT 1.011</b>	<b>C, W, T</b>
<p>The module has this group object if the Yes option is selected for the <a href="#">Pump display pump fault status</a> parameter.</p> <p>The fault state of the pump can be received via this group object and evaluated by the device</p> <p>Telegram value:     0 = Inactive                           1 = Active</p>			
<b>Input: Pump A operating status (Off/On)</b>	<b>Heating distribution circuit</b>	<b>1 bit DPT 1.011</b>	<b>C, W, T</b>
<p>The module has this group object if the Yes option is selected for the <a href="#">Pump display operating status</a> parameter.</p> <p>Input for the operating status (Off/On) provided by the pump. On pumps with their own control, this operating status can differ from the operating status of the heating distribution circuit controller.</p> <p>Telegram value:     0 = Inactive                           1 = Active</p>			
<b>In-/Output: Pump A override disable/enable</b>	<b>Heating distribution circuit</b>	<b>1 bit DPT 1.003</b>	<b>C, R, W, T</b>
<p>The module has this group object if the Yes option is selected for the <a href="#">Override by WebUI</a> parameter.</p> <p>This object activates/deactivates the pump override for the heating distribution circuit controller.</p> <p>Telegram value:     0 = Disabled                           1 = Enabled</p>			
<b>In-/Output: Pump A override value</b>	<b>Heating distribution circuit</b>	<b>1 bit DPT 1.001</b>	<b>C, R, W, T</b>
<p>The module has this group object if the Yes option is selected for the <a href="#">Override by WebUI</a> parameter.</p> <p>This object specifies the state with which the heating distribution circuit's pump is overridden if the pump override is active.</p> <p>Telegram value:     0 = Off                           1 = On</p>			

# ABB i-bus<sup>®</sup> KNX Parameters

Object function	Name (can be changed separately)	Data type	Flags
<b>Input: Pump B fault</b>	<b>Heating distribution circuit</b>	<b>1 bit DPT 1.011</b>	<b>C, W, T</b>
<p>The module has this group object if the Yes option is selected for the <a href="#">Double pump</a> parameter and the Yes option is selected for the <a href="#">Pump display pump fault status</a> parameter.</p> <p>The fault state of the second pump can be received via this group object and evaluated by the device</p> <p>Telegram value:    0 = Inactive                       1 = Active</p>			
<b>In-/Output: Pump B override disable/enable</b>	<b>Heating distribution circuit</b>	<b>1 bit DPT 1.003</b>	<b>C, R, W, T</b>
<p>The module has this group object if the Yes option is selected for the <a href="#">Double pump</a> parameter and the Yes option is selected for the <a href="#">Override by WebUI</a> parameter.</p> <p>This object activates/deactivates the second pump override for the heating distribution circuit controller.</p> <p>Telegram value:    0 = Disabled                       1 = Enabled</p>			
<b>In-/Output: Pump B override value</b>	<b>Heating distribution circuit</b>	<b>1 bit DPT 1.001</b>	<b>C, R, W, T</b>
<p>The module has this group object if the Yes option is selected for the <a href="#">Double pump</a> parameter and the Yes option is selected for the <a href="#">Override by WebUI</a> parameter.</p> <p>This object specifies the state with which the heating distribution circuit's second pump is overridden if the second pump override is active.</p> <p>Telegram value:    0 = Off                       1 = On</p>			
<b>Input: Pump B repair switch status</b>	<b>Heating distribution circuit</b>	<b>1 bit DPT 1.011</b>	<b>C, W, T</b>
<p>The module has this group object if the Yes option is selected for the <a href="#">Double pump</a> parameter and the Yes option is selected for the <a href="#">Display pump repair switch status</a> parameter.</p> <p>The status of the repair switch for the second pump can be received via this group object and evaluated by the device.</p> <p>Telegram value:    0 = Inactive                       1 = Active</p>			

# ABB i-bus<sup>®</sup> KNX Parameters

Object function	Name (can be changed separately)	Data type	Flags
<b>Input: Pump B operating status (Off/On)</b>	<b>Heating distribution circuit</b>	<b>1 bit DPT 1.011</b>	<b>C, W, T</b>
<p>The module has this group object if the Yes option is selected for the <a href="#">Double pump</a> parameter and the Yes option is selected for the <a href="#">Pump display operating status</a> parameter.</p> <p>Input for the operating status (Off/On) provided by the second pump. On pumps with their own control, this operating status can differ from the operating status of the heating distribution circuit controller.</p> <p>Telegram value:     0 = Inactive                           1 = Active</p>			
<b>Input: Pump B relay status</b>	<b>Heating distribution circuit</b>	<b>1 bit DPT 1.001</b>	<b>C, W, T</b>
<p>The module has this group object if the Yes option is selected for the <a href="#">Double pump</a> parameter.</p> <p>Input for the status of the second pump from the heating distribution circuit controller.</p> <p>Telegram value:     0 = Off                           1 = On</p>			
<b>Output: Control On/Off</b>	<b>Heating distribution circuit</b>	<b>1 bit DPT 1.001</b>	<b>C, R, T</b>
<p>The module has this group object in the following conditions:</p> <ul style="list-style-type: none"> <li>• If the Yes option is selected for the <a href="#">Supply temperature control</a> parameter and the Yes option is selected for the <a href="#">Enable heating distribution circuit control based on ASM input socket</a> parameter.</li> <li>• If the Yes option is selected for the <a href="#">Switch off if no room demand</a> parameter.</li> </ul> <p>The heating distribution circuit controller is switched on/off via this group object based on the calculations in the module.</p> <p>Telegram value:     0 = Off                           1 = On</p>			

# ABB i-bus<sup>®</sup> KNX Parameters

## 7.9.5

### BACnet objects

Type	Object name	Object type	Unit	COV send condition
Input	Heating distribution circuit: Supply setpoint temperature External specification	Analog value	°C (62)	-
Output	Heating distribution circuit: Return temperature	Analog value	°C (62)	1.0
Output	Heating distribution circuit: Supply temperature	Analog value	°C (62)	1.0
Output	Heating distribution circuit: Supply setpoint temperature status	Analog value	°C (62)	1.0
Output	Heating distribution circuit: Outside temperature	Analog value	°C (62)	1.0
Output	Heating distribution circuit: Supply setpoint temperature override status	Binary value	-	-
Output	Heating distribution circuit: Supply setpoint temperature External specification	Analog value	°C (62)	1.0
Output	Heating distribution circuit: Operation mode	Positive integer value	No unit (95)	1.0
Output	Heating distribution circuit: Room setpoint temperature Comfort	Analog value	°C (62)	1.0
Output	Heating distribution circuit: Room setpoint temperature Standby	Analog value	°C (62)	1.0
Output	Heating distribution circuit: Room setpoint temperature Economy	Analog value	°C (62)	1.0
Output	Heating distribution circuit: Room setpoint temperature Building Protection	Analog value	°C (62)	1.0
Output	Heating distribution circuit: Max. room setpoint temperature	Analog value	°C (62)	1.0
Output	Heating distribution circuit: Control On/Off	Binary value	-	-
Output	Heating distribution circuit: Room involvement	Analog value	°C (62)	1.0
Output	Heating distribution circuit: Control On/Off override disable/enable	Binary value	-	-
Output	Heating distribution circuit: Room control values	Analog value	% (98)	1.0
Output	Heating distribution circuit: Pump A override disable/enable	Binary value	-	-
Output	Heating distribution circuit: Pump A override value	Binary value	-	-
Output	Heating distribution circuit: Pump A operating status (Off/On)	Binary value	-	-
Output	Heating distribution circuit: Pump A relay status	Binary value	-	-
Output	Heating distribution circuit: Pump A fault	Binary value	-	-
Output	Heating distribution circuit: Pump A repair switch status	Binary value	-	-
Output	Heating distribution circuit: Pump B override disable/enable	Binary value	-	-
Output	Heating distribution circuit: Pump B override value	Binary value	-	-
Output	Heating distribution circuit: Pump B operating status (Off/On)	Binary value	-	-
Output	Heating distribution circuit: Pump B relay status	Binary value	-	-
Output	Heating distribution circuit: Pump B fault	Binary value	-	-
Output	Heating distribution circuit: Pump B repair switch status	Binary value	-	-
Output	Heating distribution circuit: Valve control value	Analog value	% (98)	1.0
Output	Heating distribution circuit: Valve override disable/enable	Binary value	-	-
Output	Heating distribution circuit: Valve override control value	Analog value	% (98)	1.0
Output	Heating distribution circuit: Status Valve purge	Binary value	-	-

# ABB i-bus<sup>®</sup> KNX Parameters

## BACnet input objects

Object name	Object type	Unit	COV send condition
<b>Heating distribution circuit: Supply setpoint temperature External specification</b>	<b>Analog value</b>	<b>°C (62)</b>	<b>-</b>
<p>This module has this BACnet input object if the Yes option is selected for the <a href="#">Supply temperature control</a> parameter and the <i>BACnet input object</i> option is selected for the <a href="#">Supply setpoint temperature source</a> parameter.</p> <p>Input for the specification of the supply setpoint temperature. The value is sent by the module to the heating distribution circuit controller via the related group object. This supply setpoint temperature specified via BACnet can be overridden manually on the web user interface.</p> <p>Signal value: -273...670760 °C</p>			

## BACnet output objects

Object name	Object type	Unit	COV send condition
<b>Heating distribution circuit: Return temperature</b>	<b>Analog value</b>	<b>°C (62)</b>	<b>1.0</b>
<p>Outputs the current return temperature that is received via the related group object.</p> <p>Signal value: -273...670760 °C</p>			
<b>Heating distribution circuit: Supply temperature</b>	<b>Analog value</b>	<b>°C (62)</b>	<b>1.0</b>
<p>Outputs the current supply temperature that is received via the related group object.</p> <p>Signal value: -273...670760 °C</p>			
<b>Heating distribution circuit: Supply setpoint temperature status</b>	<b>Analog value</b>	<b>°C (62)</b>	<b>1.0</b>
<p>The module has this BACnet output object if the Yes option is selected for the <a href="#">Supply temperature control</a> parameter.</p> <p>Outputs the current supply setpoint temperature as is sent by this module to the heating distribution circuit controller via the related group object. The supply setpoint temperature output here is, depending on the settings, either calculated by this module based on the outside temperature, or specified via an ASM input socket or BACnet and also takes into account any possible override of the supply setpoint temperature via the web user interface.</p> <p>Signal value: -273...670760 °C</p>			

# ABB i-bus® KNX Parameters

Object name	Object type	Unit	COV send condition
<b>Heating distribution circuit: Outside temperature</b>	<b>Analog value</b>	<b>°C (62)</b>	<b>1.0</b>
<p>This module has this BACnet output object if the <i>Yes</i> option is selected for the <a href="#">Supply temperature control</a> parameter and the <i>Calculated weather compensated</i> option is selected for the <a href="#">Supply setpoint temperature source</a> parameter.</p> <p>Outputs the current outside temperature that is used by the module for the calculation.</p> <p>Signal value:           -273...670760 °C</p>			
<b>Heating distribution circuit: Supply setpoint temperature override status</b>	<b>Binary value</b>	-	-
<p>This module has this BACnet output object if the <i>Yes</i> option is selected for the <a href="#">Supply temperature control</a> parameter and the <i>ASM input socket</i> option, <i>BACnet input object</i> option or the <i>Calculated weather compensated</i> option is selected for the <a href="#">Supply setpoint temperature source</a> parameter.</p> <p>Outputs whether the supply setpoint temperature has been overridden via the web user interface.</p> <p>Signal value:           0 = Not overridden                               1 = Overridden</p>			
<b>Heating distribution circuit: Supply setpoint temperature External specification</b>	<b>Analog value</b>	<b>°C (62)</b>	<b>1.0</b>
<p>This module has this BACnet input object if the <i>Yes</i> option is selected for the <a href="#">Supply temperature control</a> parameter and the <i>ASM input socket</i> option is selected for the <a href="#">Supply setpoint temperature source</a> parameter.</p> <p>Outputs the supply setpoint temperature specified via the ASM input socket. This status does not take into account any possible override of the supply setpoint temperature via the web user interface.</p> <p>Signal value:           -273...670760 °C</p>			
<b>Heating distribution circuit: Operation mode</b>	<b>Positive integer value</b>	<b>No unit (95)</b>	<b>1.0</b>
<p>This module has this BACnet output object if the <i>Yes</i> option is selected for the <a href="#">Supply temperature control</a> parameter, the <i>Calculated weather compensated</i> option is selected for the <a href="#">Supply setpoint temperature source</a> parameter and the <i>Based on Scheduler</i> option is selected for the <a href="#">Economy mode</a> parameter.</p> <p>Outputs the operating mode that is to be used as the basis for the calculation of the supply setpoint temperature.</p> <p>Signal value:           1 = Comfort                               2 = Standby                               3 = Economy                               4 = Building Protection</p>			

# ABB i-bus<sup>®</sup> KNX Parameters

Object name	Object type	Unit	COV send condition
<b>Heating distribution circuit: Room setpoint temperature Comfort</b>	<b>Analog value</b>	<b>°C (62)</b>	<b>1.0</b>
<p>This module has this BACnet output object if the Yes option is selected for the <a href="#">Supply temperature control</a> parameter, the <i>Calculated weather compensated</i> option is selected for the <a href="#">Supply setpoint temperature source</a> parameter and the <i>Based on Scheduler</i> option is selected for the <a href="#">Economy mode</a> parameter.</p> <p>Outputs the room setpoint temperature that is to be used as the basis for the calculation of the supply setpoint temperature in the <i>Comfort</i> operating mode if this operating mode is active.</p> <p>Signal value: -273...670760 °C</p>			
<b>Heating distribution circuit: Room setpoint temperature Standby</b>	<b>Analog value</b>	<b>°C (62)</b>	<b>1.0</b>
<p>This module has this BACnet output object if the Yes option is selected for the <a href="#">Supply temperature control</a> parameter, the <i>Calculated weather compensated</i> option is selected for the <a href="#">Supply setpoint temperature source</a> parameter, the <i>Based on Scheduler</i> option is selected for the <a href="#">Economy mode</a> parameter and the Yes option is selected for the <i>Scheduler operating mode Standby</i> parameter.</p> <p>Outputs the room setpoint temperature that is to be used as the basis for the calculation of the supply setpoint temperature in the <i>Standby</i> operating mode if this operating mode is active.</p> <p>Signal value: -273...670760 °C</p>			
<b>Heating distribution circuit: Room setpoint temperature Economy</b>	<b>Analog value</b>	<b>°C (62)</b>	<b>1.0</b>
<p>This module has this BACnet output object if the Yes option is selected for the <a href="#">Supply temperature control</a> parameter, the <i>Calculated weather compensated</i> option is selected for the <a href="#">Supply setpoint temperature source</a> parameter, the <i>Based on Scheduler</i> option is selected for the <a href="#">Economy mode</a> parameter and the Yes option is selected for the <i>Scheduler operating mode Economy</i> parameter.</p> <p>Outputs the room setpoint temperature that is to be used as the basis for the calculation of the supply setpoint temperature in the <i>Economy</i> operating mode if this operating mode is active.</p> <p>Signal value: -273...670760 °C</p>			
<b>Heating distribution circuit: Room setpoint temperature Building Protection</b>	<b>Analog value</b>	<b>°C (62)</b>	<b>1.0</b>
<p>This module has this BACnet output object if the Yes option is selected for the <a href="#">Supply temperature control</a> parameter, the <i>Calculated weather compensated</i> option is selected for the <a href="#">Supply setpoint temperature source</a> parameter, the <i>Based on Scheduler</i> option is selected for the <a href="#">Building Protection mode</a> parameter and the Yes option is selected for the <i>Scheduler operating mode Building Protection</i> parameter.</p> <p>Outputs the room setpoint temperature that is to be used as the basis for the calculation of the supply setpoint temperature in the <i>Building Protection</i> operating mode if this operating mode is active.</p> <p>Signal value: -273...670760 °C</p>			

# ABB i-bus<sup>®</sup> KNX Parameters

Object name	Object type	Unit	COV send condition
<b>Heating distribution circuit: Max. room setpoint temperature</b>	<b>Analog value</b>	<b>°C (62)</b>	<b>1.0</b>
<p>This module has this BACnet output object if the Yes option is selected for the <a href="#">Supply temperature control</a> parameter, the <i>Calculated weather compensated</i> option is selected for the <a href="#">Supply setpoint temperature source</a> parameter and the <i>Based on the current room setpoint temperatures</i> option is selected for the <a href="#">Economy mode</a> parameter.</p> <p>Outputs the highest room setpoint temperature that is present on the ASM input socket and that is used by the <i>Economy mode</i> function.</p> <p>Signal value:           -273...670760 °C</p>			
<b>Heating distribution circuit: Control On/Off</b>	<b>Binary value</b>	-	-
<p>The module has this BACnet output object in the following conditions:</p> <ul style="list-style-type: none"> <li>• If the Yes option is selected for the <a href="#">Supply temperature control</a> parameter and the Yes option is selected for the <a href="#">Enable heating distribution circuit control based on ASM input socket</a> parameter.</li> <li>• If the Yes option is selected for the <a href="#">Switch off if no room demand</a> parameter.</li> </ul> <p>Outputs the status (Off/On) of the control that is sent to the heating distribution circuit controller via the related group object. The state is dependent on the <i>Enable heating distribution circuit control based on ASM input socket</i> and <i>Switch off if no room demand</i> functions as well as any override via the web user interface.</p> <p>Signal value:           0 = Off                               1 = On</p>			
<b>Heating distribution circuit: Room involvement</b>	<b>Analog value</b>	<b>°C (62)</b>	<b>1.0</b>
<p>The module has this BACnet output object if the Yes option is selected for the <a href="#">Supply temperature control</a> parameter, the <i>Calculated weather compensated</i> option is selected for the <a href="#">Supply setpoint temperature source</a> parameter and the Yes option is selected for the <a href="#">Room involvement</a> parameter.</p> <p>Outputs of current value by which the supply setpoint temperature is increased or reduced by the <i>Room involvement</i> function.</p> <p>Signal value:           -273...670760 °C</p>			



# ABB i-bus<sup>®</sup> KNX Parameters

Object name	Object type	Unit	COV send condition
<b>Heating distribution circuit: Control On/Off override disable/enable</b>	<b>Binary value</b>	-	-
<p>The module has this BACnet output object in the following conditions:</p> <ul style="list-style-type: none"> <li>If the Yes option is selected for the <a href="#">Supply temperature control</a> parameter and the Yes option is selected for the <a href="#">Enable heating distribution circuit control based on ASM input socket</a> parameter.</li> <li>If the Yes option is selected for the <a href="#">Switch off if no room demand</a> parameter.</li> </ul> <p>Outputs whether the control (Off/On) for the heating distribution circuit controller has been overridden via the web user interface.</p> <p>Signal value:           0 = Not overridden                               1 = Overridden</p>			
<b>Heating distribution circuit: Room control values</b>	<b>Analog value</b>	<b>% (98)</b>	<b>1.0</b>
<p>The module has this BACnet output object in the following conditions:</p> <ul style="list-style-type: none"> <li>If the Yes option is selected for the <a href="#">Supply temperature control</a> parameter, the <i>Calculated weather compensated</i> option is selected for the <a href="#">Supply setpoint temperature source</a> parameter and the Yes option is selected for the <a href="#">Room involvement</a> parameter.</li> <li>If the Yes option is selected for the <a href="#">Switch off if no room demand</a> parameter.</li> </ul> <p>Outputs the highest room setpoint temperature that is present on the ASM input socket and that is used by the <i>Economy mode</i> and <i>Switch off if no room demand</i> functions.</p> <p>Signal value:           0...100 %</p>			
<b>Heating distribution circuit: Pump A override disable/enable</b>	<b>Binary value</b>	-	-
<p>The module has this BACnet output object if the Yes option is selected for the <a href="#">Override by WebUI</a> parameter.</p> <p>Outputs whether the heating distribution circuit's pump is overridden.</p> <p>Signal value:           0 = Disabled                               1 = Enabled</p>			
<b>Heating distribution circuit: Pump A override value</b>	<b>Binary value</b>	-	-
<p>The module has this BACnet output object if the Yes option is selected for the <a href="#">Override by WebUI</a> parameter.</p> <p>This object specifies the state with which the heating distribution circuit's pump is overridden if the pump override is active.</p> <p>Signal value:           0 = Off                               1 = On</p>			

# ABB i-bus<sup>®</sup> KNX Parameters

Object name	Object type	Unit	COV send condition
<b>Heating distribution circuit: Pump A operating status (Off/On)</b>	<b>Binary value</b>	-	-
<p>The module has this BACnet output object if the Yes option is selected for the <a href="#">Pump display operating status</a> parameter.</p> <p>Outputs the operating status (Off/On) provided by the pump. On pumps with their own control, this operating status can differ from the operating status of the heating distribution circuit controller.</p> <p>Signal value:       0 = Inactive                           1 = Active</p>			
<b>Heating distribution circuit: Pump A relay status</b>	<b>Binary value</b>	-	-
<p>Outputs the status of the pump from the heating distribution circuit controller.</p> <p>Signal value:       0 = Off                           1 = On</p>			
<b>Heating distribution circuit: Pump A fault</b>	<b>Binary value</b>	-	-
<p>The module has this BACnet output object if the Yes option is selected for the <a href="#">Pump display pump fault status</a> parameter.</p> <p>Outputs the fault status provided by the pump.</p> <p>Signal value:       0 = Inactive                           1 = Active</p>			
<b>Heating distribution circuit: Pump A repair switch status</b>	<b>Binary value</b>	-	-
<p>The module has this BACnet output object if the Yes option is selected for the <a href="#">Display pump repair switch status</a> parameter.</p> <p>Outputs the contact position provided by the pump repair switch.</p> <p>Signal value:       0 = Inactive                           1 = Active</p>			

# ABB i-bus<sup>®</sup> KNX Parameters

Object name	Object type	Unit	COV send condition
<b>Heating distribution circuit: Pump B override disable/enable</b>	<b>Binary value</b>	-	-
<p>The module has this BACnet output object if the Yes option is selected for the <a href="#">Double pump</a> parameter and the Yes option is selected for the <a href="#">Override by WebUI</a> parameter.</p> <p>Outputs whether the heating distribution circuit's second pump is overridden.</p> <p>Signal value:        0 = Disabled                          1 = Enabled</p>			
<b>Heating distribution circuit: Pump B override value</b>	<b>Binary value</b>	-	-
<p>The module has this BACnet output object if the Yes option is selected for the <a href="#">Double pump</a> parameter and the Yes option is selected for the <a href="#">Override by WebUI</a> parameter.</p> <p>This object specifies the state with which the heating distribution circuit's second pump is overridden if the pump override is active.</p> <p>Signal value:        0 = Off                          1 = On</p>			
<b>Heating distribution circuit: Pump B operating status (Off/On)</b>	<b>Binary value</b>	-	-
<p>The module has this BACnet output object if the Yes option is selected for the <a href="#">Double pump</a> parameter and the Yes option is selected for the <a href="#">Pump display operating status</a> parameter.</p> <p>Outputs the operating status (Off/On) provided by the second pump. On pumps with their own control, this operating status can differ from the operating status of the heating distribution circuit controller.</p> <p>Signal value:        0 = Inactive                          1 = Active</p>			
<b>Heating distribution circuit: Pump B relay status</b>	<b>Binary value</b>	-	-
<p>The module has this BACnet output object if the Yes option is selected for the <a href="#">Double pump</a> parameter.</p> <p>Outputs the status of the second pump from the heating distribution circuit controller.</p> <p>Signal value:        0 = Off                          1 = On</p>			

# ABB i-bus<sup>®</sup> KNX Parameters

Object name	Object type	Unit	COV send condition
<b>Heating distribution circuit: Pump B fault</b>	<b>Binary value</b>	-	-
<p>The module has this BACnet output object if the Yes option is selected for the <a href="#">Double pump</a> parameter and the Yes option is selected for the <a href="#">Pump display pump fault status</a> parameter.</p> <p>Outputs the fault status provided by the second pump.</p> <p>Signal value:       0 = Inactive                           1 = Active</p>			
<b>Heating distribution circuit: Pump B repair switch status</b>	<b>Binary value</b>	-	-
<p>The module has this BACnet output object if the Yes option is selected for the <a href="#">Double pump</a> parameter and the Yes option is selected for the <a href="#">Display pump repair switch status</a> parameter.</p> <p>Outputs the contact position provided by the second pump repair switch.</p> <p>Signal value:       0 = Inactive                           1 = Active</p>			
<b>Heating distribution circuit: Valve control value</b>	<b>Analog value</b>	<b>% (98)</b>	<b>1.0</b>
<p>The module has this BACnet output object if the <i>3-way valve (mixing valve)</i> option or the <i>2-way valve</i> option is selected for the <a href="#">Valve type</a> parameter.</p> <p>Outputs the valve control value for the heating distribution circuit. This value is received from the heating distribution circuit controller linked via the related module group object.</p> <p>Signal value:       0...100%</p>			
<b>Heating distribution circuit: Valve override disable/enable</b>	<b>Binary value</b>	-	-
<p>The module has this BACnet output object if the <i>3-way valve (mixing valve)</i> option or the <i>2-way valve</i> option is selected for the <a href="#">Valve type</a> parameter and the Yes option is selected for the <a href="#">Valve override disable/enable</a> parameter.</p> <p>Outputs whether the override of the heating distribution circuit's valve is active or inactive.</p> <p>Signal value:       0 = Disabled                           1 = Enabled</p>			

# ABB i-bus<sup>®</sup> KNX Parameters

Object name	Object type	Unit	COV send condition
<b>Heating distribution circuit: Valve override control value</b>	<b>Analog value</b>	<b>% (98)</b>	<b>1.0</b>
<p>The module has this BACnet output object if the <i>3-way valve (mixing valve)</i> option or the <i>2-way valve</i> option is selected for the <a href="#">Valve type</a> parameter and the Yes option is selected for the <a href="#">Valve override disable/enable</a> parameter.</p> <p>Outputs the value used to override the heating distribution circuit's valve if the override is active.</p> <p>Signal value:        0...100 %</p>			
<b>Heating distribution circuit: Status Valve purge</b>	<b>Binary value</b>	-	-
<p>The module has this BACnet output object if the <i>3-way valve (mixing valve)</i> option or the <i>2-way valve</i> option is selected for the <a href="#">Valve type</a> parameter and the Yes option is selected for the <a href="#">Status Valve purge</a> parameter.</p> <p>Outputs the status as to whether the heating distribution circuit controller is actually undertaking a valve purge. This value is received from the heating distribution circuit controller linked via the related module group object.</p> <p>Signal value:        0 = Inactive                          1 = Active</p>			

# ABB i-bus<sup>®</sup> KNX Parameters

7.9.6

## WebUI

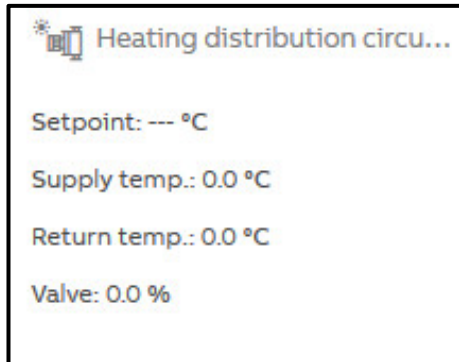

Open the detailed view of the ASM by clicking the ASM's tile.

The detailed view consists of two pages on which you make various settings in the individual sections.

### Distribution circuit page



This section shows the current operating status of the heating distribution circuit controller linked via KNX.

If activated in the settings, the control by the heating distribution circuit controller can be overridden by the "admin" and "expert" users via the web user interface. For this purpose the slider must be dragged to one of the two "Override" positions. The current state of the heating distribution circuit controller continues to be displayed in "Auto" during the override.

# ABB i-bus<sup>®</sup> KNX Parameters

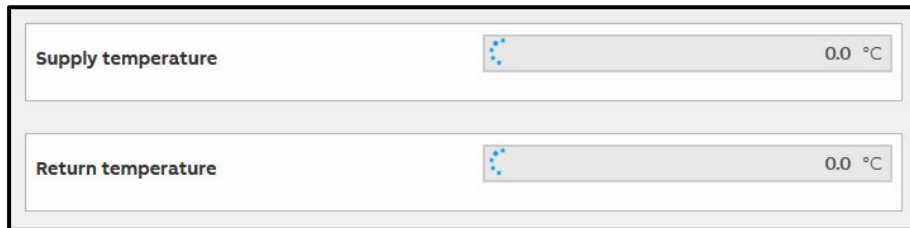

Supply temperature	0.0 °C
Return temperature	0.0 °C

This section displays the current supply and return temperatures from the heating distribution circuit controller linked via KNX.

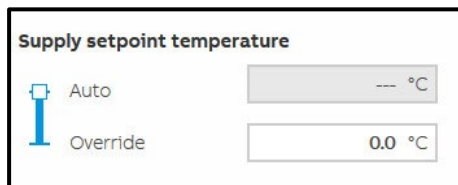

Supply setpoint temperature	
<input type="checkbox"/> Auto	--- °C
<input checked="" type="checkbox"/> Override	0.0 °C

This section displays the current supply setpoint temperature calculated by this module. This temperature is sent via KNX to the heating distribution circuit controller linked.

If activated in the settings, the supply setpoint temperature can be overridden by the "admin" and "expert" users via the web user interface. For this purpose the slider must be dragged to the "Override" position. A supply setpoint temperature continues to be calculated and displayed in "Auto" during the override. In this way you can see the value that will be used after changing the slider.

# ABB i-bus<sup>®</sup> KNX Parameters

The screenshot shows a control panel for "Pump A". On the left, there is a vertical slider with a blue bar. The slider has three positions: "Auto" at the top, "Override: Off" in the middle, and "Override: On" at the bottom. To the right of the slider are four status buttons, each with a blue icon of a gear and a dot. The buttons are: "Status Pump relay: Off", "Pump operating status: Inactive", "Pump fault: No alarm", and "Repair switch: Inactive".

This section displays the state of the pump from the heating distribution circuit controller linked. If a double pump has been activated in the settings, a second section with the label "Pump B" appears. The settings described here for "Pump A" apply correspondingly to the section for "Pump B".

If activated in the settings, the pump for the heating distribution circuit controller can be overridden by the "admin" and "expert" users via the web user interface. For this purpose the slider must be dragged to one of the two "Override" positions.

## Status Pump relay

Outputs the status of the pump from the heating distribution circuit controller linked.

## Pump operating status

Outputs the operating status (Off/On) provided by the pump. On pumps with their own control, this operating status can differ from the operating status of the heating distribution circuit controller.

## Pump fault

Outputs the fault status provided by the pump.

## Repair switch

Outputs the contact position provided by the pump repair switch.



# ABB i-bus<sup>®</sup> KNX Parameters

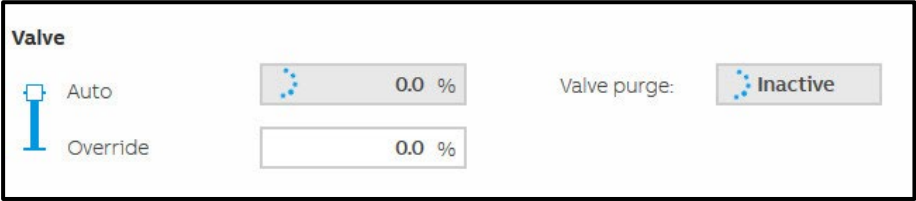

This section displays the valve position from the heating distribution circuit controller linked via KNX. It is also indicated whether a valve purge is in progress.

If activated in the settings, the valve position can be overridden by the "admin" and "expert" users via the web user interface. For this purpose the slider must be dragged to the "Override" position. The status sent by the heating distribution circuit controller continues to be displayed in "Auto" during the override.

# ABB i-bus<sup>®</sup> KNX Parameters

## Supply temperature page

On this page it is shown how the supply setpoint temperature is calculated. The settings on which the calculation is based can be changed.

The information displayed on this page may vary depending on which settings have been selected for the supply setpoint temperature calculation in the ASM settings.

<b>Status</b>	
Outside temperature	-6.5 °C
Room setpoint temperature Comfort	21.0 °C
Room setpoint temperature Standby	16.0 °C
Room setpoint temperature Economy	19.0 °C
Room setpoint temperature Building Protection	8.0 °C
Max. room control value	10.0 %
Room involvement	 0.0 K
Operating mode	Comfort

This section shows the current status of the calculation. These values cannot be changed by the user.

# ABB i-bus<sup>®</sup> KNX

## Parameters

### **Outside temperature**

Outputs the current outside temperature that is used by the module for the calculation.

### **Room setpoint temperature Comfort / Standby / Economy / Building Protection**

Outputs the highest room setpoint temperatures for the related heating operating modes for all rooms connected to the heating distribution circuit. This value is used by the *Economy mode* function.

### **Max. room setpoint temperature**

Outputs the highest room setpoint temperatures for heating for all rooms connected to the heating distribution circuit. This value is used by the *Room involvement* function.

### **Max. room control value**

Outputs the highest heating control values (valve positions) for all rooms connected to the heating distribution circuit. The value is used by the *Room involvement* function to adjust the heating curve and therefore the supply setpoint temperature to the current needs. This value is used by the *Switch off if no room demand* function to switch off the heating distribution circuit controller.

### **Room involvement**

Outputs of current value by which the supply setpoint temperature is increased or reduced by the *Room involvement* function. This value is also shown on the "Heating curve" chart on the web user interface.

# ABB i-bus<sup>®</sup> KNX Parameters

Settings	
Heating curve	
Nominal outside temperature	<input type="text" value="-14.0 °C"/>
Nominal room temperature	<input type="text" value="20.0 °C"/>
Nominal supply temperature	<input type="text" value="80.0 °C"/>
Nominal return temperature	<input type="text" value="60.0 °C"/>
Max. supply temperature	<input type="text" value="80.0 °C"/>
Radiator exponent	<input type="text" value="Radiator to DIN 4703 (1.30)"/>
Start heating curve at outside temperature	<input type="text" value="19.0 °C"/>
Room involvement	
Increase supply temperature	<input type="text" value="10.0 K"/>
Decrease supply temperature	<input type="text" value="-10.0 K"/>
Optimum room control value	<input type="text" value="70.0 %"/>
Controller proportional factor Xp	<input type="text" value="30.0 %"/>

The parameter set in the ASM settings can be changed in this section via the web user interface. This is advantageous so that the settings can be adapted to the local situation during the operating of the system without renewed ETS programming.

The settings on the web user interface always apply. The parameters set in the ASM settings are overwritten and only become active again on the reinstallation of the ASM.

You will find the description of the ASM settings in the chapter [7.15.2 Settings](#).

# ABB i-bus<sup>®</sup> KNX Parameters

## Heating curve chart

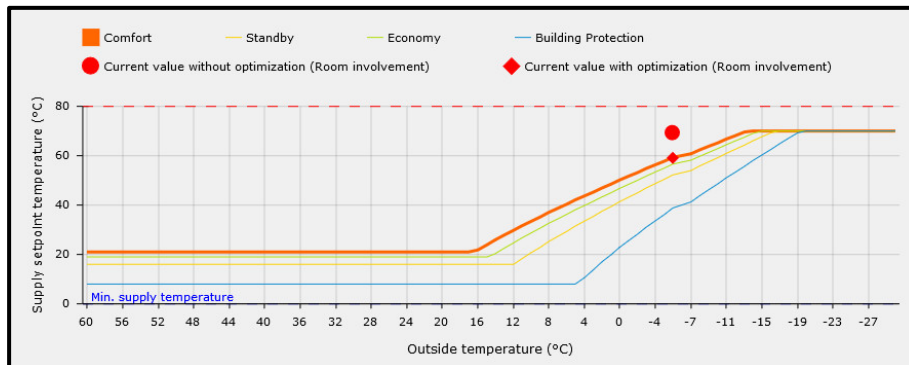

The heating curve for the ASM is shown graphically in this section. The chart shows, on the one hand, the static heating curve based on the ASM settings and, on the other hand, the current values for the *Economy mode* and *Room involvement* functions.

## Custom heating curve chart

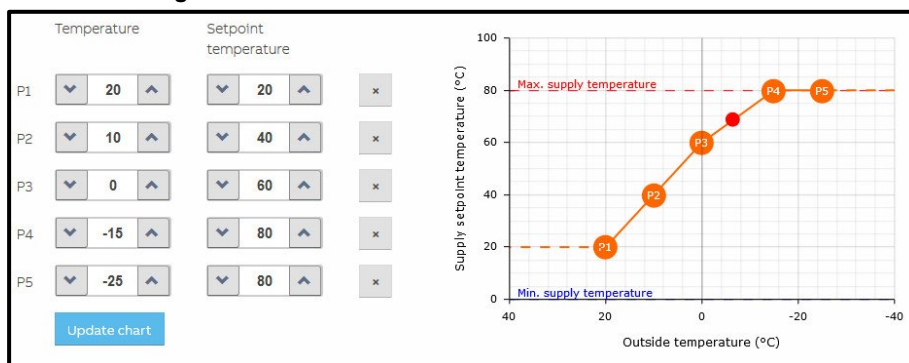

If the supply setpoint temperature is calculated based on the weather and in the ASM settings the *Custom* option is selected for the *Calculation formula* parameter, you can change the curve on the web user interface by specifying the points. The points from the ASM settings parameterized are used as the initial values.

The settings on the web user interface always apply. The parameters set in the ASM settings are overwritten and only become active again on the reinstallation of the ASM.

# ABB i-bus<sup>®</sup> KNX Parameters

## 7.10 Heat generator ASM

### 7.10.1 General

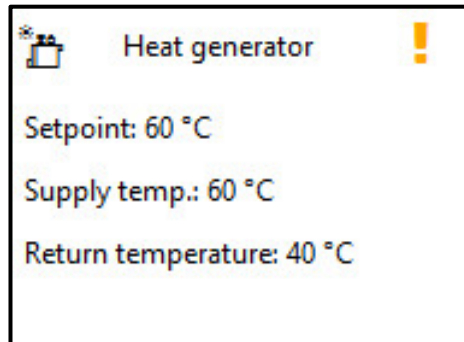

This application-specific automation module (ASM) calculates the supply setpoint temperature and sends the value calculated to a heat generator linked via KNX. The module also allows the heat generator to be displayed and operated via the module's web user interface

# ABB i-bus<sup>®</sup> KNX Parameters

7.10.2

Settings

General	
Name	Heat generator
Description	
Reinstall	<input type="checkbox"/>
Heat generator	
Enable heat generator based on A...	<input type="checkbox"/>
Show operating status	<input type="checkbox"/>
Show fault status	<input type="checkbox"/>
Supply setpoint temperature	
Supply temperature control	<input checked="" type="checkbox"/>
Supply setpoint temperature source	Calculated weather compe... ▼
Calculation formula	Heating curve ▼
Nominal outside temperature	-14 ▲▼ °C
Nominal room temperature	20 ▲▼ °C
Nominal supply temperature	80 ▲▼ °C
Nominal return temperature	60 ▲▼ °C
Max. supply temperature	80 ▲▼ °C
Radiator exponent	Radiators to DIN 4703 (1.30) ▼
Start supply temperature curve at...	19 ▲▼ °C
Economy mode	Disabled ▼
Room involvement	<input type="checkbox"/>
Switch off if no room demand	<input type="checkbox"/>
Pump	
Pump	<input checked="" type="checkbox"/>
Override by WebUI	<input type="checkbox"/>
Pump display operating status	<input type="checkbox"/>
Pump display pump fault status	<input type="checkbox"/>
Display pump repair switch status	<input type="checkbox"/>

### General

You will find descriptions of the global settings (Name, Description, Reinstall, BACnet, WebUI) in [chapter 7.3, Global ASM settings](#).

# ABB i-bus<sup>®</sup> KNX Parameters

## **Heat generator**

### **Enable heat generator based on ASM input socket**

Options:            No (checkbox cleared)  
                      Yes (checkbox selected)

If this function is activated, an additional ASM input object for switching off/on the heat generator is activated; the value of this object is then forwarded to a heat generator via a group object that is then displayed.

If the [Switch off if no room demand](#) function is also activated, there is the following relationship:

<b>ASM input socket Heat generator On/Off</b>	<b>Result of the Switch off if no room demand function</b>	<b>Result and output in the Heat generator On/Off group object</b>
Off	Switched off	Off
On	Switched off	On
Off	Switched on	Off
On	Switched on	On

### **Show operating status**

Options:            No (checkbox cleared)  
                      Yes (checkbox selected)

If the heat generator outputs its operating status (Off/On), this status can be received by a group object via this function and output on the web user interface, in a BACnet object and on the ASM socket.

### **Show fault status**

Options:            No (checkbox cleared)  
                      Yes (checkbox selected)

If the heat generator outputs its fault status, this status can be received by a group object via this function and output on the web user interface, in a BACnet object and on the ASM socket.

The ASM only displays this state, there are no switching actions based on the fault status.



# ABB i-bus<sup>®</sup> KNX Parameters

## **Supply setpoint temperature**

In this parameter window it is specified how the supply setpoint temperature for the heat generator is calculated.

## **Supply temperature control**

Options:            No (checkbox cleared)  
                      Yes (checkbox selected)

On the selection of the Yes option, the ASM calculates the supply setpoint temperature and sends the value calculated to the heat generator via the group object. Other parameters define how the calculation is undertaken.

Selection of Yes option:

Dependent parameter(s):

### **Supply setpoint temperature source**

Options:            ASM input socket  
                      WebUI Input  
                      BACnet input object  
                      Calculated weather compensated

This parameter determines how the supply setpoint temperature is determined for the heat generator. This setpoint is sent to the heat generator via the group object.

- *ASM input socket*: The supply setpoint temperature received via the input socket on the ASM is used. This is an ASM multiple socket on which the highest value present is used.
- *WebUI Input*: The supply setpoint temperature is set on the web user interface for the ASM.
- *BACnet input object*: The supply setpoint temperature received via the BACnet object for the ASM is used.
- *Calculated weather compensated*: The module calculates the supply setpoint temperature currently required based on the outside temperature.

# ABB i-bus<sup>®</sup> KNX

## Parameters

Selection of *ASM input socket* or *BACnet input object* option:

Dependent parameter(s):

### **Supply setpoint temperature offset**

Options: 0...100 °C

An offset can be entered to compensate for the energy losses in the pipes. This value is always added to the supply setpoint temperature and is limited by the *Max. supply temperature* parameter.

Selection of *WebUI Input* or *BACnet input object* option:

Dependent parameter(s):

### **Initial values**

### **Supply setpoint temperature**

Options: 0...80...100 °C

This parameter defines the supply setpoint temperature that is output after downloading the module. This value is output until a new value is entered on the web user interface or is written to the BACnet object. This value is limited by the *Max. supply temperature* parameter.

# ABB i-bus<sup>®</sup> KNX Parameters

Selection of *Calculated weather compensated* option:

Dependent parameter(s):

### Calculation formula

Options:        Heating curve  
                  Custom

This parameter specifies the method used to determine the currently required supply setpoint temperature based on the outside temperature. The relationship between the outside temperature and the supply temperature is depicted by a curve.

- *Heating curve*: A heating curve based on the nominal values (design values) for the heating is calculated. These nominal values stem from the basic planning for the heating system and are based on the design point. The heating curve can be seen on the web user interface for the module. The values for the curve cannot be changed directly.
- *Custom*: The shape of the curve can be set as required by entering the points.

Selection of *Heating curve* option:

Dependent parameter(s):

### Nominal outside temperature

Options:        -100...-14...100 °C

The outside temperature at the design point is specified using this parameter. This is normally the lowest outside temperature for which the heating system is designed. This information is used to calculate the heating curve.

### Nominal room temperature

Options:        0...20...100 °C

The room temperature at the design point is specified using this parameter. This value is used to calculate the heating curve and has no relationship to the actual room setpoint temperature used.

# ABB i-bus<sup>®</sup> KNX Parameters

## **Nominal supply temperature**

Options: 0...80...100 °C

The supply temperature at the design point is specified using this parameter. This is normally the highest supply temperature for the heating system that is set at the lowest outside temperature. This information is used to calculate the heating curve.

## **Nominal return temperature**

Options: 0...60...100 °C

The theoretical return temperature at the design point is specified using this parameter. This information provides the spread between the supply and return temperature. This information is used to calculate the heating curve.

## **Max. supply temperature**

Options: 0...80...100 °C

The supply setpoint temperature output by the module is limited using this parameter. This is a safety function that ensures a supply setpoint temperature too high for the heating system is not output under any circumstances. For example, the supply setpoint temperature for floor heating can be limited to maximum 35 °C.

# ABB i-bus<sup>®</sup> KNX Parameters

## Radiator exponent

Options:      None/Linear (1.0)  
                  Floor heating (1.05)  
                  Floor heating (1.10)  
                  Flat radiators (1.20)  
                  Flat radiators (1.25)  
                  Radiator to DIN 4703 (1.30)  
                  Flat radiators (1.33)  
                  Convectors (1.35)  
                  Convectors (1.40)  
                  Convectors (1.45)  
                  Convectors (1.50)

The radiator exponent is dependent on the type and design of the heating element and is normally stated by the manufacturer. The radiator exponent describes the relationship between the increasing supply temperature and the non-proportionally increasing heat dissipation into the room.

This information is used to calculate the heating curve. The higher this value is, the more curved the heating curve is.

## Start supply temperature curve at outside temperature

Options:      -100...19...100 °C

The outside temperature at which heating is started is specified using this parameter. This value is the start of the heating curve. The heating limit is dependent on the insulation standards in the building and can be selected lower, the better the building is insulated.

## Economy mode

Options:     Disabled  
              Based on Scheduler  
              Based on the current room setpoint temperatures

The heating curve, and therefore the supply setpoint temperature, is as standard only a theoretical value that is exclusively dependent on the outside temperature.

This parameter specifies that, in addition to the theoretical nominal room setpoint temperature, the actual room setpoint temperature flows into the calculation and the calculated heating curve is correspondingly lowered in times with low room setpoint temperatures. The term "nighttime reduction" is also used. In this way during times with low heat demand in the rooms, the heat provided is reduced to lower the losses and therefore save energy.

- *Disabled*: The heating curve is static and based only on the parameterized nominal room temperature. There is no dynamic lowering of the heating curve.
- *Based on Scheduler*: The heating curve is adjusted dynamically based on a scheduler. The scheduler switches between the operating modes and the related room setpoint temperatures. A heating curve is displayed for each operating mode and the mode activated is marked on the web user interface for the module. An ASM input socket for connecting an operating mode scheduler is displayed on activating this function. Which operating modes are used can be set using the parameters that follow. An ASM input socket is also displayed for each of these operating modes activated; the related room setpoint temperature is passed to the module using this input socket.
- *Based on the current room setpoint temperatures*: The heating curve is adjusted dynamically based on the room setpoint temperatures currently active in the rooms. An ASM input socket configured for the selection of the maximum is displayed on activating this function. All room setpoint temperatures for the heating circuit are connected to this object; the module selects the highest room setpoint temperature as the basis for the calculation.

# ABB i-bus<sup>®</sup> KNX Parameters

Selection of *Based on Scheduler* option:

Dependent parameter(s):

### **Scheduler operating mode Standby**

Options:        No (checkbox cleared)  
                  Yes (checkbox selected)

The "Standby" operating mode is activated using this parameter and a corresponding ASM input socket displayed.

### **Scheduler operating mode Economy**

Options:        No (checkbox cleared)  
                  Yes (checkbox selected)

The "Economy" operating mode is activated using this parameter and a corresponding ASM input socket displayed.

### **Scheduler operating mode Building Protection**

Options:        No (checkbox cleared)  
                  Yes (checkbox selected)

The "Building Protection" operating mode is activated using this parameter and a corresponding ASM input socket displayed.

Selection of *Custom* option:

Dependent parameter(s):

## Custom supply temperature curve

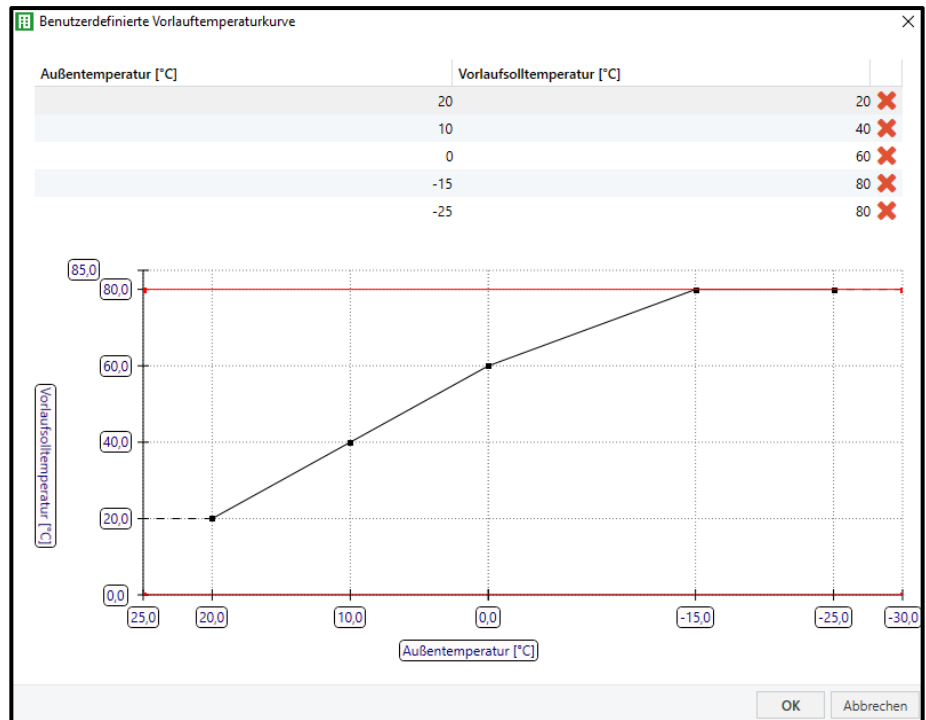

After you click the "Edit" button, a window opens where you can add a custom supply temperature curve by changing the supply setpoint temperature. The shape of the curve can be set as required by entering the points. The limit specified via the *Max. supply temperature* parameter is displayed on the chart as a red line.

This curve is used after downloading the module and can be modified via the web user interface for the module.



# ABB i-bus<sup>®</sup> KNX Parameters

## Room involvement

Options: No (checkbox cleared)  
Yes (checkbox selected)

The heating curve, and therefore the supply setpoint temperature, is as standard only a theoretical value that is exclusively dependent on the outside temperature.

By activating the "Economy mode" function the room setpoint temperatures can also flow into the calculation; however the actual heat demand from the rooms connected to the heat generator is not taken into account. Along with the outside temperature, the actual heat demand is dependent on the sunlight, wind speed and internal heat loads such as people, electrical equipment and lighting.

With room involvement, the heating curve can be raised and lowered dynamically based on the actual room demand.

The advantage here is that at any time the optimum supply setpoint for the heating system is used. In this way during times with low heat demand in the rooms, the heat provided is reduced to lower the losses and therefore save energy. On the other hand, in times with increased heat demand from the rooms, the amount of heat provided is increased. In this way the required comfort temperature is reached more quickly in the rooms.

The current heat demand from the rooms is determined by evaluating the control values from the room thermostats (e.g. radiator valve position). For this purpose an input socket is displayed to link the control values. The module determines the highest value from the control values linked.

Based on the parameters that follow, the module raises or lowers the heating curve and therefore the supply setpoint temperature over a longer period until the optimum control value is reached. Here the highest control value is always taken as the reference. If the control value leaves the optimum value, the adaptation starts again from the beginning.

The current adaptation of the heating curve is displayed on the web user interface for the module. The calculation takes place every 5 minutes.

# ABB i-bus<sup>®</sup> KNX

## Parameters

Prerequisites for the correct function of room involvement:

- All control values from the room valves in the heating circuit are available and connected to the ASM input socket. There must therefore not be any conventional thermostats in the heating circuit.
- The heating circuit has been balanced hydraulically.
- The following parameters for the room involvement function have been optimized. For this purpose the complete heating system normally needs to be observed and optimized over several weeks.

Selection of Yes option:

Dependent parameter(s)

### **Increase supply temperature**

Options: 0...10...100 K

This parameter specifies the maximum value up to which the supply setpoint temperature is allowed to be increased by the "Room involvement" function. This increase relates to the value specified by the heating curve. A value of 0 K deactivates the increase by the room involvement.

### **Decrease supply temperature**

Options: -100...-10...0 K

This parameter specifies the minimum value up to which the supply setpoint temperature is allowed to be reduced by the "Room involvement" function. This reduction relates to the value specified by the heating curve. A value of 0 K deactivates the reduction by the room involvement.

# ABB i-bus<sup>®</sup> KNX Parameters

## **Optimum room control value**

Options: 10...70...90 %

The Room involvement function increases and reduces the supply setpoint temperature until the highest of the room control values linked to the ASM input socket reaches this optimum value.

## **Controller proportional factor Xp**

Options: 10...30...90 %

Proportional range of the P controller used for the room involvement. The smaller the value set, the faster the control reacts. However, the value should not be selected too small because otherwise there may be a risk of overshoot.

Example:

The value Xp = 30 % means: If the highest control value on the ASM input socket is 30 % below the *Optimum room control value*, the supply temperature increases by the full value of *Increase supply temperature*.

## **Room involvement calculation delay**

Options: 00:00:00...00.45.00...23:59:00 hh:mm:ss

This parameter delays the calculation of the room involvement (and therefore the increase/reduction of the supply temperature) after starting the device so that the heating system can reach a steady state.

# ABB i-bus<sup>®</sup> KNX

## Parameters

### Switch off if no room demand

Options:            No (checkbox cleared)  
                      Yes (checkbox selected)

With this function the module monitors the room control values and automatically switches on and off the heat generator connected accordingly.

It is a prerequisite for this function that all control values from the room valves in the heating system are available and connected to the ASM input socket. There must therefore not be any conventional thermostats in the heating system.

This function is affected by the [Enable heat generator based on ASM input socket](#) function. If both functions are activated, the [Enable heat generator based on ASM input socket](#) has a higher priority.

Selection of Yes option:

Dependent parameter(s)

### Switch on if the room demand is higher than

Options:            0...10...100 %

The module sends a switch-on command to the heat generator if the highest room control value present on the ASM input socket exceeds this value.

### Switch off if the room demand is equal to or less than

Options:            0...100 %

The module sends a switch-off command to the heat generator if the highest room control value present on the ASM input socket is the same as or less than this value.

# ABB i-bus<sup>®</sup> KNX Parameters

## **Pump**

Settings for the heat generator's pump.

## **Pump**

Options:            No (checkbox cleared)  
                      Yes (checkbox selected)

This parameter specifies whether a pump is used in the heating system. The group objects, BACnet objects, ASM sockets and the depiction on the web user interface are adjusted to suit the setting.

## **Override by WebUI**

Options:            No (checkbox cleared)  
                      Yes (checkbox selected)

If this function is activated, the pump can be overridden via the web user interface. For this purpose additional group objects are displayed that must be connected to the heat generator's pump.

## **Pump display operating status**

Options:            No (checkbox cleared)  
                      Yes (checkbox selected)

If the pump outputs its operating status (Off/On), this status can be received by a group object via this function and output on the web user interface, in a BACnet object and on the ASM socket.

# ABB i-bus<sup>®</sup> KNX

## Parameters

### **Pump display pump fault status**

Options:            No (checkbox cleared)  
                      Yes (checkbox selected)

If the pump outputs its fault status, this status can be received by a group object via this function and output on the web user interface, in a BACnet object and on the ASM socket. The ASM only displays this state, there are no switching actions based on the fault status.

### **Display pump repair switch status**

Options:            No (checkbox cleared)  
                      Yes (checkbox selected)

If the pump has a repair switch and the contact position is output, this status can be received by a group object via this function and output on the web user interface, in a BACnet object and on the ASM socket.

# ABB i-bus<sup>®</sup> KNX Parameters

## 7.10.3

### Sockets

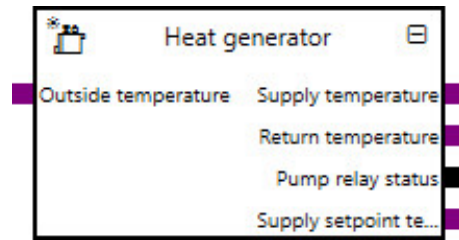

Overview of the ASM sockets for linking to other modules:

Type	Object name	Data type
Input	Heat generator operating status	1.001
Input	Supply setpoint temperature External specification	9.001
Input	Outside temperature	9.001
Input	Room setpoint temperature Comfort	9.001
Input	Room setpoint temperature Standby	9.001
Input	Room setpoint temperature Economy	9.001
Input	Room setpoint temperature Building Protection	9.001
Input	Room control values	5.001
Input	Room setpoint temperature	9.001
Input	Operating mode	20.102
Output	Supply temperature	9.001
Output	Return temperature	9.001
Output	Heat generator On/Off	1.001
Output	Pump operating status (Off/On)	1.011
Output	Pump relay status	1.001
Output	Pump fault	1.005
Output	Pump repair switch status	1.011
Output	Pump override disable/enable	1.003
Output	Pump override value	1.001
Output	Supply setpoint temperature	9.001
Output	Supply setpoint temperature External specification	9.001
Output	Room involvement	9.002
Output	Max. room setpoint temperature	9.001
Output	Heat generator operating status	1.001
Output	Heat generator failure status	1.001

# ABB i-bus<sup>®</sup> KNX

## Parameters

### Input sockets

Object name	Data type
<b>Heat generator operating status</b>	<b>DPT 1.001</b>
<p>This module has this input socket if the <b>Yes</b> option is selected for the <a href="#">Supply temperature control</a> parameter and the <b>Yes</b> option is selected for the <a href="#">Enable heat generator based on ASM input socket</a> parameter.</p> <p>The heat generator connected can be switched on and off by another module via this input. This is a multiple input socket on which the input signals are linked via an OR operator.</p> <p>Signal value:        0 = Off                           1 = On</p>	
<b>Supply setpoint temperature External specification</b>	<b>DPT 9.001</b>
<p>This module has this input socket if the <b>Yes</b> option is selected for the <a href="#">Supply temperature control</a> parameter and the <i>ASM input socket</i> option is selected for the <a href="#">Supply setpoint temperature source</a> parameter.</p> <p>Specification of the supply setpoint temperature by another module. This value is output in the corresponding group objects to the heat generator linked.</p> <div style="background-color: #f0f0f0; padding: 5px;"> <p> <b>Note</b></p> <p>The value can be affected by the <i>Max. supply temperature</i> and <i>Supply setpoint temperature offset</i> parameters in the module.</p> </div> <p>Signal value:        -273...670760 °C</p>	
<b>Outside temperature</b>	<b>DPT 9.001</b>
<p>This module has this input socket if the <b>Yes</b> option is selected for the <a href="#">Supply temperature control</a> parameter and the <i>Calculated weather compensated</i> option is selected for the <a href="#">Supply setpoint temperature source</a> parameter.</p> <p>Input for the outside temperature. The supply setpoint temperature is calculated by the module from the heating curve based on this value.</p> <p>Signal value:        -273...670760 °C</p>	



# ABB i-bus<sup>®</sup> KNX Parameters

Object name	Data type
<b>Room setpoint temperature Comfort</b>	<b>DPT 9.001</b>
<p>This module has this input socket if the Yes option is selected for the <a href="#">Supply temperature control</a> parameter, the <i>Calculated weather compensated</i> option is selected for the <a href="#">Supply setpoint temperature source</a> parameter and the <i>Based on Scheduler</i> option is selected for the <a href="#">Economy mode</a> parameter.</p> <p>Input for the room setpoint temperature in the Comfort operating mode for the heating operating type for the rooms connected to the heating system. The module selects the highest value and uses this value for the <i>Economy mode</i> function to adjust the heating curve and therefore the supply setpoint temperature to the current needs.</p> <p>Signal value: -273...670760 °C</p>	
<b>Room setpoint temperature Standby</b>	<b>DPT 9.001</b>
<p>This module has this input socket if the Yes option is selected for the <a href="#">Supply temperature control</a> parameter, the <i>Calculated weather compensated</i> option is selected for the <a href="#">Supply setpoint temperature source</a> parameter, the <i>Based on Scheduler</i> option is selected for the <a href="#">Economy mode</a> parameter and the Yes option is selected for the <i>Scheduler operating mode Standby</i> parameter.</p> <p>Input for the room setpoint temperature in the Standby operating mode for the heating operating type for the rooms connected to the heating system. The module selects the highest value and uses this value for the <i>Economy mode</i> function to adjust the heating curve and therefore the supply setpoint temperature to the current needs.</p> <p>Signal value: -273...670760 °C</p>	
<b>Room setpoint temperature Economy</b>	<b>DPT 9.001</b>
<p>This module has this input socket if the Yes option is selected for the <a href="#">Supply temperature control</a> parameter, the <i>Calculated weather compensated</i> option is selected for the <a href="#">Supply setpoint temperature source</a> parameter, the <i>Based on Scheduler</i> option is selected for the <a href="#">Economy mode</a> parameter and the Yes option is selected for the <i>Scheduler operating mode Economy</i> parameter.</p> <p>Input for the room setpoint temperature in the Economy operating mode for the heating operating type for the rooms connected to the heating system. The module selects the highest value and uses this value for the <i>Economy mode</i> function to adjust the heating curve and therefore the supply setpoint temperature to the current needs.</p> <p>Signal value: -273...670760 °C</p>	
<b>Room setpoint temperature Building Protection</b>	<b>DPT 9.001</b>
<p>This module has this input socket if the Yes option is selected for the <a href="#">Supply temperature control</a> parameter, the <i>Calculated weather compensated</i> option is selected for the <a href="#">Supply setpoint temperature source</a> parameter, the <i>Based on Scheduler</i> option is selected for the <a href="#">Economy mode</a> parameter and the Yes option is selected for the <i>Scheduler operating mode Building Protection</i> parameter.</p> <p>Input for the room setpoint temperature in the Building Protection operating mode for the heating operating type for the rooms connected to the heating system. The module selects the highest value and uses this value for the <i>Economy mode</i> function to adjust the heating curve and therefore the supply setpoint temperature to the current needs.</p> <p>Signal value: -273...670760 °C</p>	

# ABB i-bus<sup>®</sup> KNX

## Parameters

Object name	Data type
<b>Room control values</b>	<b>5.001</b>
<p>The module has this input socket in the following conditions:</p> <ul style="list-style-type: none"> <li>• If the Yes option is selected for the <a href="#">Supply temperature control</a> parameter, the <i>Calculated weather compensated</i> option is selected for the <a href="#">Supply setpoint temperature source</a> parameter and the Yes option is selected for the <a href="#">Room involvement</a> parameter.</li> <li>• If the Yes option is selected for the <a href="#">Switch off if no room demand</a> parameter.</li> </ul> <p>Input for the "heating" control values (valve positions) for all rooms connected to the heating system. The module selects the highest value and uses this value for the <i>Room involvement</i> and <i>Switch off if no room demand</i> functions to adjust the heating curve and therefore the supply setpoint temperature to the current needs.</p> <p>Signal value: 0...100%</p>	
<b>Room setpoint temperature</b>	<b>DPT 9.001</b>
<p>This module has this input socket if the Yes option is selected for the <a href="#">Supply temperature control</a> parameter, the <i>Calculated weather compensated</i> option is selected for the <a href="#">Supply setpoint temperature source</a> parameter and the <i>Based on the current room setpoint temperatures</i> option is selected for the <a href="#">Economy mode</a> parameter.</p> <p>Input for the current "heating" room setpoint temperatures for all rooms connected to the heating system. The module selects the highest value and uses this value for the <i>Economy mode</i> function to adjust the heating curve and therefore the supply setpoint temperature to the current needs.</p> <p>Signal value: -273...670760 °C</p>	
<b>Operating mode</b>	<b>DPT 20.102</b>
<p>This module has this input socket if the Yes option is selected for the <a href="#">Supply temperature control</a> parameter, the <i>Calculated weather compensated</i> option is selected for the <a href="#">Supply setpoint temperature source</a> parameter and the <i>Based on Scheduler</i> option is selected for the <a href="#">Economy mode</a> parameter.</p> <p>Input for the current "heating" operating mode for the rooms connected to the heating system. The module uses this value for the <i>Economy mode</i> function to adjust the heating curve and therefore the supply setpoint temperature to the current needs.</p> <p>Signal value: 1 = Comfort 2 = Standby 3 = Economy 4 = Building Protection</p>	

# ABB i-bus<sup>®</sup> KNX Parameters

## Output sockets

Object name	Data type
<b>Supply temperature</b>	<b>DPT 9.001</b>
Outputs the current supply temperature that is received via the related group object.	
Signal value:           -273...670760 °C	
<b>Return temperature</b>	<b>DPT 9.001</b>
Outputs the current return temperature that is received via the related group object.	
Signal value:           -273...670760 °C	
<b>Heat generator On/Off</b>	<b>DPT 1.001</b>
The module has this output socket in the following conditions:	
<ul style="list-style-type: none"> <li>• If the Yes option is selected for the <a href="#">Supply temperature control</a> parameter and the Yes option is selected for the <a href="#">Enable heat generator based on ASM input socket</a> parameter.</li> <li>• If the Yes option is selected for the <a href="#">Switch off if no room demand</a> parameter.</li> </ul>	
Outputs the on/off status of the heat generator that is sent to the heat generator via the related group object. The state is dependent on the <a href="#">Enable heat generator based on ASM input socket</a> and <a href="#">Switch off if no room demand</a> parameters.	
Signal value:           0 = Off 1 = On	
<b>Pump operating status (Off/On)</b>	<b>DPT 1.011</b>
The module has this output socket if the Yes option is selected for the <a href="#">Pump display operating status</a> parameter.	
Outputs the operating status (Off/On) provided by the pump. On pumps with their own control, this operating status can differ from the operating status of the heat generator.	
Signal value:           0 = Inactive 1 = Active	
<b>Pump relay status</b>	<b>DPT 1.001</b>
Outputs the status of the pump from the heat generator.	
Signal value:           0 = Off 1 = On	

# ABB i-bus® KNX Parameters

Object name	Data type
<b>Pump fault</b>	<b>DPT 1.005</b>
<p>The module has this output socket if the Yes option is selected for the <a href="#">Pump display pump fault status</a> parameter.</p> <p>Outputs the fault status provided by the pump.</p> <p>Signal value:        0 = No alarm                           1 = Alarm</p>	
<b>Pump repair switch status</b>	<b>DPT 1.011</b>
<p>The module has this output socket if the Yes option is selected for the <a href="#">Display pump repair switch status</a> parameter.</p> <p>Outputs the contact position provided by the pump repair switch.</p> <p>Signal value:        0 = Inactive                           1 = Active</p>	
<b>Pump override disable/enable</b>	<b>DPT 1.003</b>
<p>The module has this output socket if the Yes option is selected for the <a href="#">Override by WebUI</a> parameter.</p> <p>Outputs whether the heat generator's pump is overridden.</p> <p>Signal value:        0 = Disabled                           1 = Enabled</p>	
<b>Pump override value</b>	<b>DPT 1.001</b>
<p>The module has this output socket if the Yes option is selected for the <a href="#">Override by WebUI</a> parameter.</p> <p>Outputs the state with which the heat generator's pump is overridden if the pump override is active.</p> <p>Signal value:        0 = Off                           1 = On</p>	
<b>Supply setpoint temperature</b>	<b>DPT 9.001</b>
<p>The module has this output socket if the Yes option is selected for the <a href="#">Supply temperature control</a> parameter.</p> <p>Outputs the current supply setpoint temperature as is sent by the module to the heat generator via the related group object. The supply setpoint temperature output here is, depending on the setting, either calculated by this module based on the outside temperature, or specified via an ASM input socket or BACnet and also takes into account any possible override of the supply setpoint temperature via the web user interface.</p> <p>Signal value:        -273...670760 °C</p>	
<b>Supply setpoint temperature External specification</b>	<b>DPT 9.001</b>
<p>This module has this output socket if the Yes option is selected for the <a href="#">Supply temperature control</a> parameter and the <i>BACnet input object</i> option is selected for the <a href="#">Supply setpoint temperature source</a> parameter.</p> <p>Outputs the supply setpoint temperature specified via the BACnet object. This status does not take into account any possible override of the supply setpoint temperature via the web user interface.</p> <p>Signal value:        -273...670760 °C</p>	

# ABB i-bus<sup>®</sup> KNX Parameters

Object name	Data type
<b>Room involvement</b>	<b>DPT 9.002</b>
<p>The module has this output socket if the Yes option is selected for the <a href="#">Supply temperature control</a> parameter, the <i>Calculated weather compensated</i> option is selected for the <a href="#">Supply setpoint temperature source</a> parameter and the Yes option is selected for the <a href="#">Room involvement</a> parameter.</p> <p>Outputs of current value by which the supply setpoint temperature is increased or reduced by the <i>Room involvement</i> function.</p> <p>Signal value:           -670760...670760 K</p>	
<b>Max. room setpoint temperature</b>	<b>DPT 9.001</b>
<p>This module has this output socket if the Yes option is selected for the <a href="#">Supply temperature control</a> parameter, the <i>Calculated weather compensated</i> option is selected for the <a href="#">Supply setpoint temperature source</a> parameter and the <i>Based on the current room setpoint temperatures</i> option is selected for the <a href="#">Economy mode</a> parameter.</p> <p>Outputs the highest room setpoint temperature that is present on the ASM input socket and that is used by the <i>Economy mode</i> function.</p> <p>Signal value:           -273...670760 °C</p>	
<b>Heat generator operating status</b>	<b>DPT 1.001</b>
<p>The module has this output socket if the Yes option is selected for the <a href="#">Show operating status</a> parameter.</p> <p>Outputs the operating status (Off/On) provided by the heat generator. Due to the control integrated into the heat generator, this status may differ from the operating status specified by this module.</p> <p>Signal value:           0 = Off                               1 = On</p>	
<b>Heat generator failure status</b>	<b>DPT 1.001</b>
<p>The module has this output socket if the Yes option is selected for the <a href="#">Show fault status</a> parameter.</p> <p>Outputs the fault status provided by the heat generator.</p> <p>Signal value:           0 = Off                               1 = On</p>	

# ABB i-bus<sup>®</sup> KNX Parameters

## 7.10.4

### Group objects

Object function	Name (can be changed separately)	Data point type (DPT)	Length	Flags						
				C	R	W	T	U	I	
Input: Supply temperature	Heat generator	9.001	2 bytes	x		x	x			
Input: Return temperature	Heat generator	9.001	2 bytes	x		x	x			
Output: Supply setpoint temperature	Heat generator	9.001	2 bytes	x	x		x			
Input: Pump relay status	Heat generator	1.001	1 bit	x		x	x			
Output: Heat generator On/Off	Heat generator	1.001	1 bit	x	x		x			
Input: Heat generator operating status	Heat generator	1.011	1 bit	x		x	x			
Input: Heat generator failure status	Heat generator	1.011	1 bit	x		x	x			
In-/Output: Pump override disable/enable	Heat generator	1.003	1 bit	x	x	x	x			
In-/Output: Pump override value	Heat generator	1.001	1 bit	x	x	x	x			
Input: Pump operating status (Off/On)	Heat generator	1.011	1 bit	x		x	x			
Input: Pump fault	Heat generator	1.011	1 bit	x		x	x			
Input: Pump repair switch status	Heat generator	1.011	1 bit	x		x	x			

# ABB i-bus<sup>®</sup> KNX Parameters

Object function	Name (can be changed separately)	Data type	Flags
<b>Input: Supply temperature</b>	<b>Heat generator</b>	<b>2 bytes DPT 9.001</b>	<b>C, W, T</b>
Input for supply temperature measured in the heat generator. Telegram value: -273...670760 °C			
<b>Input: Return temperature</b>	<b>Heat generator</b>	<b>2 bytes DPT 9.001</b>	<b>C, W, T</b>
Input for return temperature measured in the heat generator. Telegram value: -273...670760 °C			
<b>Output: Supply setpoint temperature</b>	<b>Heat generator</b>	<b>2 bytes DPT 9.001</b>	<b>C, R, T</b>
Outputs the supply setpoint temperature calculated by the module as the value specified to the heat generator. Telegram value: -273...670760 °C			
<b>Input: Pump relay status</b>	<b>Heat generator</b>	<b>1 bit DPT 1.001</b>	<b>C, W, T</b>
The module has this group object if the Yes option is selected for the <a href="#">Pump</a> parameter. Input for the status of the heat generator's pump. Telegram value: 0 = Off 1 = On			
<b>Output: Heat generator On/Off</b>	<b>Heat generator</b>	<b>1 bit DPT 1.001</b>	<b>C, R, T</b>
The module has this group object in the following conditions: <ul style="list-style-type: none"> <li>• If the Yes option is selected for the <a href="#">Supply temperature control</a> parameter and the Yes option is selected for the <a href="#">Enable heat generator based on ASM input socket</a> parameter.</li> <li>• If the Yes option is selected for the <a href="#">Switch off if no room demand</a> parameter.</li> </ul> Output for switching on/off the heat generator. Telegram value: 0 = Off 1 = On			

# ABB i-bus<sup>®</sup> KNX Parameters

Object function	Name (can be changed separately)	Data type	Flags
<b>Input: Heat generator operating status</b>	<b>Heat generator</b>	<b>1 bit DPT 1.011</b>	<b>C, W, T</b>
<p>The module has this group object if the <b>Yes</b> option is selected for the <a href="#">Show operating status</a> parameter.</p> <p>Input for the operating status (Off/On) provided by the heat generator. Due to the control integrated into the heat generator, this status may differ from the operating status specified by this module.</p> <p>Telegram value:    0 = Inactive                       1 = Active</p>			
<b>Input: Heat generator failure status</b>	<b>Heat generator</b>	<b>1 bit DPT 1.011</b>	<b>C, W, T</b>
<p>The module has this group object if the <b>Yes</b> option is selected for the <a href="#">Show fault status</a> parameter.</p> <p>Input for the fault status provided by the heat generator.</p> <p>Signal value:       0 = Inactive                       1 = Active</p>			
<b>In-/Output: Pump override disable/enable</b>	<b>Heat generator</b>	<b>1 bit DPT 1.003</b>	<b>C, R, W, T</b>
<p>The module has this group object if the <b>Yes</b> option is selected for the <a href="#">Override by WebUI</a> parameter.</p> <p>This object activates/deactivates the override of the heat generator's pump.</p> <p>Telegram value:    0 = Disabled                       1 = Enabled</p>			
<b>In-/Output: Pump override value</b>	<b>Heat generator</b>	<b>1 bit DPT 1.001</b>	<b>C, R, W, T</b>
<p>The module has this group object if the <b>Yes</b> option is selected for the <a href="#">Override by WebUI</a> parameter.</p> <p>This object specifies the state with which the heat generator's pump is overridden if the pump override is active.</p> <p>Telegram value:    0 = Off                       1 = On</p>			



# ABB i-bus<sup>®</sup> KNX Parameters

Object function	Name (can be changed separately)	Data type	Flags
<b>Input: Pump operating status (Off/On)</b>	<b>Heat generator</b>	<b>1 bit DPT 1.011</b>	<b>C, W, T</b>
<p>The module has this group object if the Yes option is selected for the <a href="#">Pump display operating status</a> parameter.</p> <p>Input for the operating status (Off/On) provided by the pump.</p> <p>Telegram value:     0 = Inactive                           1 = Active</p>			
<b>Input: Pump fault</b>	<b>Heat generator</b>	<b>1 bit DPT 1.011</b>	<b>C, W, T</b>
<p>The module has this group object if the Yes option is selected for the <a href="#">Pump display pump fault status</a> parameter.</p> <p>Input for the fault status provided by the pump.</p> <p>Telegram value:     0 = Inactive                           1 = Active</p>			
<b>Input: Pump repair switch status</b>	<b>Heat generator</b>	<b>1 bit DPT 1.011</b>	<b>C, W, T</b>
<p>The module has this group object if the Yes option is selected for the <a href="#">Display pump repair switch status</a> parameter.</p> <p>Input for the contact position provided by the pump repair switch.</p> <p>Telegram value:     0 = Inactive                           1 = Active</p>			

# ABB i-bus<sup>®</sup> KNX Parameters

## 7.10.5

### BACnet objects

Type	Object name	Object type	Unit	COV send condition
Input	Heat generator: Supply setpoint temperature External specification	Analog value	°C (62)	-
Output	Heat generator: Return temperature	Analog value	°C (62)	1.0
Output	Heat generator: Supply temperature	Analog value	°C (62)	1.0
Output	Heat generator: Supply setpoint temperature status	Analog value	°C (62)	1.0
Output	Heat generator: Outside temperature	Analog value	°C (62)	1.0
Output	Heat generator: Supply setpoint temperature override status	Binary value	-	-
Output	Heat generator: Supply setpoint temperature External specification	Analog value	°C (62)	1.0
Output	Heat generator: Operation mode	Positive integer value	No unit (95)	1.0
Output	Heat generator: Room setpoint temperature Comfort	Analog value	°C (62)	1.0
Output	Heat generator: Room setpoint temperature Standby	Analog value	°C (62)	1.0
Output	Heat generator: Room setpoint temperature Economy	Analog value	°C (62)	1.0
Output	Heat generator: Room setpoint temperature Building Protection	Analog value	°C (62)	1.0
Output	Heat generator: Max. room setpoint temperature	Analog value	°C (62)	1.0
Output	Heat generator: Heat generator On/Off	Binary value	-	-
Output	Heat generator: Room involvement	Analog value	°C (62)	1.0
Output	Heat generator: Control On/Off override disable/enable	Binary value	-	-
Output	Heat generator: Heat generator operating status	Binary value	-	-
Output	Heat generator: Heat generator failure status	Binary value	-	-
Output	Heat generator: Room control values	Analog value	% (98)	1.0
Output	Heat generator: Pump override disable/enable	Binary value	-	-
Output	Heat generator: Pump override value	Binary value	-	-
Output	Heat generator: Pump operating status (Off/On)	Binary value	-	-
Output	Heat generator: Pump relay status	Binary value	-	-
Output	Heat generator: Pump fault	Binary value	-	-
Output	Heat generator: Pump repair switch status	Binary value	-	-

# ABB i-bus<sup>®</sup> KNX Parameters

## BACnet input objects

Object name	Object type	Unit	COV send condition
<b>Heat generator: Supply setpoint temperature External specification</b>	<b>Analog value</b>	<b>°C (62)</b>	<b>-</b>
<p>This module has this BACnet input object if the Yes option is selected for the <a href="#">Supply temperature control</a> parameter and the <i>BACnet input object</i> option is selected for the <a href="#">Supply setpoint temperature source</a> parameter.</p> <p>Input for the specification of the supply setpoint temperature. The value is sent by the module to the heat generator via the related group object. This supply setpoint temperature specified via BACnet can be overridden manually on the web user interface.</p> <p>Signal value: -273...670760 °C</p>			

## BACnet output objects

Object name	Object type	Unit	COV send condition
<b>Heat generator: Return temperature</b>	<b>Analog value</b>	<b>°C (62)</b>	<b>1.0</b>
<p>Outputs the current return temperature that is received via the related group object.</p> <p>Signal value: -273...670760 °C</p>			
<b>Heat generator: Supply temperature</b>	<b>Analog value</b>	<b>°C (62)</b>	<b>1.0</b>
<p>Outputs the current supply temperature that is received via the related group object.</p> <p>Signal value: -273...670760 °C</p>			
<b>Heat generator: Supply setpoint temperature status</b>	<b>Analog value</b>	<b>°C (62)</b>	<b>1.0</b>
<p>The module has this BACnet output object if the Yes option is selected for the <a href="#">Supply temperature control</a> parameter.</p> <p>Outputs the current supply setpoint temperature as is sent by this module to the heat generator via the related group object. The supply setpoint temperature output here is, depending on the settings, either calculated by this module based on the outside temperature, or specified via an ASM input socket or BACnet and also takes into account any possible override of the supply setpoint temperature via the web user interface.</p> <p>Signal value: -273...670760 °C</p>			

# ABB i-bus<sup>®</sup> KNX Parameters

Object name	Object type	Unit	COV send condition
<b>Heat generator: Outside temperature</b>	<b>Analog value</b>	<b>°C (62)</b>	<b>1.0</b>
<p>This module has this BACnet output object if the <i>Yes</i> option is selected for the <a href="#">Supply temperature control</a> parameter and the <i>Calculated weather compensated</i> option is selected for the <a href="#">Supply setpoint temperature source</a> parameter.</p> <p>Outputs the current outside temperature that is used by the module for the calculation.</p> <p>Signal value:           -273...670760 °C</p>			
<b>Heat generator: Supply setpoint temperature override status</b>	<b>Binary value</b>	-	-
<p>This module has this BACnet output object if the <i>Yes</i> option is selected for the <a href="#">Supply temperature control</a> parameter and the <i>ASM input socket</i> option, <i>BACnet input object</i> option or the <i>Calculated weather compensated</i> option is selected for the <a href="#">Supply setpoint temperature source</a> parameter.</p> <p>Outputs whether the supply setpoint temperature has been overridden via the web user interface.</p> <p>Signal value:           0 = Not overridden                             1 = Overridden</p>			
<b>Heat generator: Supply setpoint temperature External specification</b>	<b>Analog value</b>	<b>°C (62)</b>	<b>1.0</b>
<p>This module has this BACnet input object if the <i>Yes</i> option is selected for the <a href="#">Supply temperature control</a> parameter and the <i>ASM input socket</i> option is selected for the <a href="#">Supply setpoint temperature source</a> parameter.</p> <p>Outputs the supply setpoint temperature specified via the ASM input socket. This status does not take into account any possible override of the supply setpoint temperature via the web user interface.</p> <p>Signal value:           -273...670760 °C</p>			
<b>Heat generator: Operation mode</b>	<b>Positive integer value</b>	<b>No unit (95)</b>	<b>1.0</b>
<p>This module has this BACnet output object if the <i>Yes</i> option is selected for the <a href="#">Supply temperature control</a> parameter, the <i>Calculated weather compensated</i> option is selected for the <a href="#">Supply setpoint temperature source</a> parameter and the <i>Based on Scheduler</i> option is selected for the <a href="#">Economy mode</a> parameter.</p> <p>Outputs the operating mode that is to be used as the basis for the calculation of the supply setpoint temperature.</p> <p>Signal value:           1 = Comfort                             2 = Standby                             3 = Economy                             4 = Building Protection</p>			

# ABB i-bus<sup>®</sup> KNX Parameters

Object name	Object type	Unit	COV send condition
<b>Heat generator: Room setpoint temperature Comfort</b>	<b>Analog value</b>	<b>°C (62)</b>	<b>1.0</b>
<p>This module has this BACnet output object if the Yes option is selected for the <a href="#">Supply temperature control</a> parameter, the <i>Calculated weather compensated</i> option is selected for the <a href="#">Supply setpoint temperature source</a> parameter and the <i>Based on Scheduler</i> option is selected for the <a href="#">Economy mode</a> parameter.</p> <p>Outputs the room setpoint temperature that is to be used as the basis for the calculation of the supply setpoint temperature in the <i>Comfort</i> operating mode if this operating mode is active.</p> <p>Signal value: -273...670760 °C</p>			
<b>Heat generator: Room setpoint temperature Standby</b>	<b>Analog value</b>	<b>°C (62)</b>	<b>1.0</b>
<p>This module has this BACnet output object if the Yes option is selected for the <a href="#">Supply temperature control</a> parameter, the <i>Calculated weather compensated</i> option is selected for the <a href="#">Supply setpoint temperature source</a> parameter, the <i>Based on Scheduler</i> option is selected for the <a href="#">Economy mode</a> parameter and the Yes option is selected for the <i>Scheduler operating mode Standby</i> parameter.</p> <p>Outputs the room setpoint temperature that is to be used as the basis for the calculation of the supply setpoint temperature in the <i>Standby</i> operating mode if this operating mode is active.</p> <p>Signal value: -273...670760 °C</p>			
<b>Heat generator: Room setpoint temperature Economy</b>	<b>Analog value</b>	<b>°C (62)</b>	<b>1.0</b>
<p>This module has this BACnet output object if the Yes option is selected for the <a href="#">Supply temperature control</a> parameter, the <i>Calculated weather compensated</i> option is selected for the <a href="#">Supply setpoint temperature source</a> parameter, the <i>Based on Scheduler</i> option is selected for the <a href="#">Economy mode</a> parameter and the Yes option is selected for the <i>Scheduler operating mode Economy</i> parameter.</p> <p>Outputs the room setpoint temperature that is to be used as the basis for the calculation of the supply setpoint temperature in the <i>Economy</i> operating mode if this operating mode is active.</p> <p>Signal value: -273...670760 °C</p>			
<b>Heat generator: Room setpoint temperature Building Protection</b>	<b>Analog value</b>	<b>°C (62)</b>	<b>1.0</b>
<p>This module has this BACnet output object if the Yes option is selected for the <a href="#">Supply temperature control</a> parameter, the <i>Calculated weather compensated</i> option is selected for the <a href="#">Supply setpoint temperature source</a> parameter, the <i>Based on Scheduler</i> option is selected for the <a href="#">Building Protection mode</a> parameter and the Yes option is selected for the <i>Scheduler operating mode Building Protection</i> parameter.</p> <p>Outputs the room setpoint temperature that is to be used as the basis for the calculation of the supply setpoint temperature in the <i>Building Protection</i> operating mode if this operating mode is active.</p> <p>Signal value: -273...670760 °C</p>			

# ABB i-bus<sup>®</sup> KNX Parameters

Object name	Object type	Unit	COV send condition
<b>Heat generator: Max. room setpoint temperature</b>	<b>Analog value</b>	<b>°C (62)</b>	<b>1.0</b>
<p>This module has this BACnet output object if the Yes option is selected for the <a href="#">Supply temperature control</a> parameter, the <i>Calculated weather compensated</i> option is selected for the <a href="#">Supply setpoint temperature source</a> parameter and the <i>Based on the current room setpoint temperatures</i> option is selected for the <a href="#">Economy mode</a> parameter.</p> <p>Outputs the highest room setpoint temperature that is present on the ASM input socket and that is used by the <i>Economy mode</i> function.</p> <p>Signal value:           -273...670760 °C</p>			
<b>Heat generator: Heat generator On/Off</b>	<b>Binary value</b>	-	-
<p>The module has this BACnet output object in the following conditions:</p> <ul style="list-style-type: none"> <li>• If the Yes option is selected for the <a href="#">Supply temperature control</a> parameter and the Yes option is selected for the <a href="#">Enable heat generator based on ASM input socket</a> parameter.</li> <li>• If the Yes option is selected for the <a href="#">Switch off if no room demand</a> parameter.</li> </ul> <p>Outputs the on/off status of the heat generator that is sent to the heat generator via the related group object. The state is dependent on the <i>Enable heat generator based on ASM input socket</i> and <i>Switch off if no room demand</i> functions as well as override via the web user interface.</p> <p>Signal value:           0 = Off                           1 = On</p>			
<b>Heat generator: Room involvement</b>	<b>Analog value</b>	<b>°C (62)</b>	<b>1.0</b>
<p>The module has this BACnet output object if the Yes option is selected for the <a href="#">Supply temperature control</a> parameter, the <i>Calculated weather compensated</i> option is selected for the <a href="#">Supply setpoint temperature source</a> parameter and the Yes option is selected for the <a href="#">Room involvement</a> parameter.</p> <p>Outputs of current value by which the supply setpoint temperature is increased or reduced by the <i>Room involvement</i> function.</p> <p>Signal value:           -273...670760 °C</p>			

# ABB i-bus<sup>®</sup> KNX Parameters

Object name	Object type	Unit	COV send condition
<b>Heat generator: Control On/Off override disable/enable</b>	<b>Binary value</b>	-	-
<p>The module has this BACnet output object in the following conditions:</p> <ul style="list-style-type: none"> <li>• If the Yes option is selected for the <a href="#">Supply temperature control</a> parameter and the Yes option is selected for the <a href="#">Enable heat generator based on ASM input socket</a> parameter.</li> <li>• If the Yes option is selected for the <a href="#">Switch off if no room demand</a> parameter.</li> </ul> <p>Outputs whether heat generator on/off has been overridden via the web user interface.</p> <p>Signal value:           0 = Not overridden                               1 = Overridden</p>			
<b>Heat generator: Heat generator operating status</b>	<b>Binary value</b>	-	-
<p>The module has this BACnet output object if the Yes option is selected for the <a href="#">Show operating status</a> parameter.</p> <p>Outputs the operating status (Off/On) provided by the heat generator. Due to the control integrated into the heat generator, this status may differ from the operating status specified by this module.</p> <p>Signal value:           0 = Off                               1 = On</p>			
<b>Heat generator: Heat generator failure status</b>	<b>Binary value</b>	-	-
<p>The module has this BACnet output object if the Yes option is selected for the <a href="#">Show fault status</a> parameter.</p> <p>Outputs the fault status provided by the heat generator.</p> <p>Signal value:           0 = Off                               1 = On</p>			
<b>Heat generator: Room control values</b>	<b>Analog value</b>	<b>% (98)</b>	<b>1.0</b>
<p>The module has this BACnet output object in the following conditions:</p> <ul style="list-style-type: none"> <li>• If the Yes option is selected for the <a href="#">Supply temperature control</a> parameter, the <i>Calculated weather compensated</i> option is selected for the <a href="#">Supply setpoint temperature source</a> parameter and the Yes option is selected for the <a href="#">Room involvement</a> parameter.</li> <li>• If the Yes option is selected for the <a href="#">Switch off if no room demand</a> parameter.</li> </ul> <p>Outputs the highest room setpoint temperature that is present on the ASM input socket and that is used by the <i>Economy mode</i> and <i>Switch off if no room demand</i> functions.</p> <p>Signal value:           0...100 %</p>			

# ABB i-bus<sup>®</sup> KNX Parameters

Object name	Object type	Unit	COV send condition
<b>Heat generator: Pump override disable/enable</b>	<b>Binary value</b>	-	-
<p>The module has this BACnet output object if the Yes option is selected for the <a href="#">Override by WebUI</a> parameter.</p> <p>Outputs whether the heat generator's pump is overridden.</p> <p>Signal value:       0 = Disabled                           1 = Enabled</p>			
<b>Heat generator: Pump override value</b>	<b>Binary value</b>	-	-
<p>The module has this BACnet output object if the Yes option is selected for the <a href="#">Override by WebUI</a> parameter.</p> <p>This object specifies the state with which the heat generator's pump is overridden if the pump override is active.</p> <p>Signal value:       0 = Off                           1 = On</p>			
<b>Heat generator: Pump operating status (Off/On)</b>	<b>Binary value</b>	-	-
<p>The module has this BACnet output object if the Yes option is selected for the <a href="#">Pump display operating status</a> parameter.</p> <p>Outputs the operating status (Off/On) provided by the pump. On pumps with their own control, this operating status can differ from the operating status of the heat generator.</p> <p>Signal value:       0 = Inactive                           1 = Active</p>			
<b>Heat generator: Pump relay status</b>	<b>Binary value</b>	-	-
<p>Outputs the status of the heat generator's pump.</p> <p>Signal value:       0 = Off                           1 = On</p>			



# ABB i-bus<sup>®</sup> KNX Parameters

Object name	Object type	Unit	COV send condition
<b>Heat generator: Pump fault</b>	<b>Binary value</b>	-	-
<p>The module has this BACnet output object if the Yes option is selected for the <a href="#">Pump display pump fault status</a> parameter.</p> <p>Outputs the fault status provided by the pump.</p> <p>Signal value:       0 = Inactive                           1 = Active</p>			
<b>Heat generator: Pump repair switch status</b>	<b>Binary value</b>	-	-
<p>The module has this BACnet output object if the Yes option is selected for the <a href="#">Display pump repair switch status</a> parameter.</p> <p>Outputs the contact position provided by the pump repair switch.</p> <p>Signal value:       0 = Inactive                           1 = Active</p>			

# ABB i-bus<sup>®</sup> KNX Parameters

7.10.6

WebUI

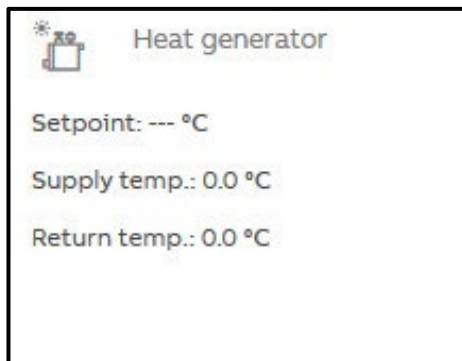

Open the detailed view of the ASM by clicking the ASM's tile.

The detailed view consists of two pages on which you make various settings in the individual sections.

## Heat generator page

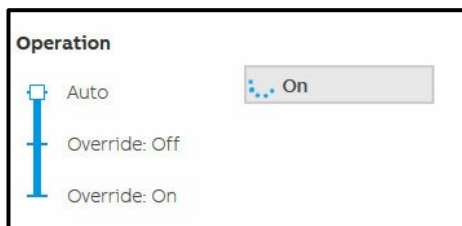

This section shows the current operating status of the heat generator linked via KNX.

If activated in the settings, the control by the heat generator can be overridden by the "admin" and "expert" users via the web user interface. For this purpose the slider must be dragged to one of the two "Override" positions. The current state of the heat generator continues to be displayed in "Auto" during the override.

# ABB i-bus<sup>®</sup> KNX Parameters

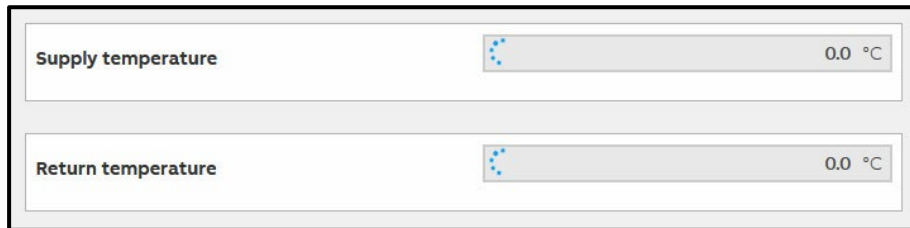

Supply temperature	0.0 °C
Return temperature	0.0 °C

This section displays the current supply and return temperatures from the heat generator linked via KNX.

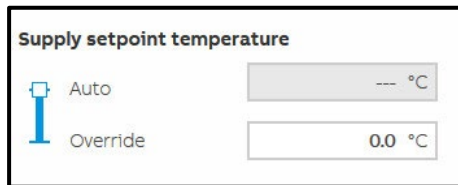

<b>Supply setpoint temperature</b>	
<input type="checkbox"/> Auto	--- °C
<input checked="" type="checkbox"/> Override	0.0 °C

This section displays the current supply setpoint temperature calculated by this module. This temperature is sent via KNX to the heat generator linked.

If activated in the settings, the supply setpoint temperature can be overridden by the "admin" and "expert" users via the web user interface. For this purpose the slider must be dragged to the "Override" position. A supply setpoint temperature continues to be calculated and displayed in "Auto" during the override. In this way you can see the value that will be used after changing the slider.

# ABB i-bus® KNX Parameters

<b>Pump</b>		Status Pump relay:	<input type="button" value="Off"/>
<input type="checkbox"/> Auto		Pump operating status:	<input type="button" value="Inactive"/>
<input checked="" type="checkbox"/> Override: Off		Pump fault:	<input type="button" value="No alarm"/>
<input type="checkbox"/> Override: On		Repair switch:	<input type="button" value="Inactive"/>

This section displays the state of the pump from the heat generator linked.

If activated in the settings, the pump for the heat generator can be overridden by the "admin" and "expert" users via the web user interface. For this purpose the slider must be dragged to one of the two "Override" positions.

## Status Pump relay

Outputs the status of the pump from the heat generator linked.

## Pump operating status

Outputs the operating status (Off/On) provided by the pump. On pumps with their own control, this operating status can differ from the operating status of the heat generator.

## Pump fault

Outputs the fault status provided by the pump.

## Repair switch

Outputs the contact position provided by the pump repair switch.

# ABB i-bus<sup>®</sup> KNX Parameters



This section displays the state of the heat generator linked.

## **Status**

Outputs the operating status provided by the heat generator linked.

## **Pump fault**

Outputs the fault status provided by the heat generator linked.

# ABB i-bus<sup>®</sup> KNX Parameters

## **Supply temperature page**

On this page it is shown how the supply setpoint temperature is calculated. The settings on which the calculation is based can be changed.

The information displayed on this page may vary depending on which settings have been selected for the supply setpoint temperature calculation in the ASM settings.

<b>Status</b>	
Outside temperature	-6.5 °C
Room setpoint temperature Comfort	21.0 °C
Room setpoint temperature Standby	16.0 °C
Room setpoint temperature Economy	19.0 °C
Room setpoint temperature Building Protection	8.0 °C
Max. room control value	10.0 %
Room involvement	 0.0 K
Operating mode	Comfort

This section shows the current status of the calculation. These values cannot be changed by the user.

# ABB i-bus<sup>®</sup> KNX

## Parameters

### **Outside temperature**

Outputs the current outside temperature that is used by the module for the calculation.

### **Room setpoint temperature Comfort / Standby / Economy / Building Protection**

Outputs the highest room setpoint temperatures for the related heating operating modes for all rooms connected to the heating system. This value is used by the *Economy mode* function.

### **Max. room setpoint temperature**

Outputs the highest room setpoint temperatures for heating for all rooms connected to the heating system. This value is used by the *Room involvement* function.

### **Max. room control value**

Outputs the highest heating control values (valve positions) for all rooms connected to the heating system. The value is used by the *Room involvement* function to adjust the heating curve and therefore the supply setpoint temperature to the current needs. This value is used by the *Switch off if no room demand* function to switch off the heat generator.

### **Room involvement**

Outputs of current value by which the supply setpoint temperature is increased or reduced by the *Room involvement* function. This value is also shown on the "Heating curve" chart on the web user interface.

# ABB i-bus<sup>®</sup> KNX Parameters

Settings	
Heating curve	
Nominal outside temperature	<input type="text" value="-14.0 °C"/>
Nominal room temperature	<input type="text" value="20.0 °C"/>
Nominal supply temperature	<input type="text" value="80.0 °C"/>
Nominal return temperature	<input type="text" value="60.0 °C"/>
Max. supply temperature	<input type="text" value="80.0 °C"/>
Radiator exponent	<input type="text" value="Radiator to DIN 4703 (1.30)"/>
Start heating curve at outside temperature	<input type="text" value="19.0 °C"/>
Room involvement	
Increase supply temperature	<input type="text" value="10.0 K"/>
Decrease supply temperature	<input type="text" value="-10.0 K"/>
Optimum room control value	<input type="text" value="70.0 %"/>
Controller proportional factor Xp	<input type="text" value="30.0 %"/>

The parameter set in the ASM settings can be changed in this section via the web user interface. This is advantageous so that the settings can be adapted to the local situation during the operating of the system without renewed ETS programming.

The settings on the web user interface always apply. The parameters set in the ASM settings are overwritten and only become active again on the reinstallation of the ASM.

You will find the description of the ASM settings in the chapter [7.17.2 Settings](#).



# ABB i-bus<sup>®</sup> KNX Parameters

## Heating curve chart

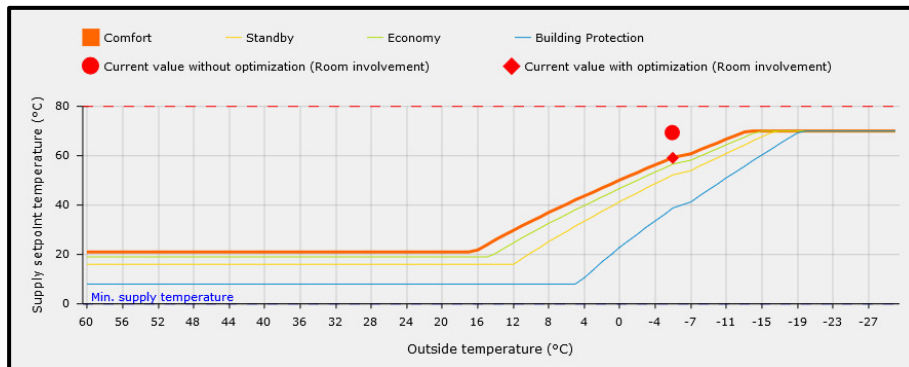

The heating curve for the ASM is shown graphically in this section. The chart shows, on the one hand, the static heating curve based on the ASM settings and, on the other hand, the current values for the *Economy mode* and *Room involvement* functions.

## Custom heating curve chart

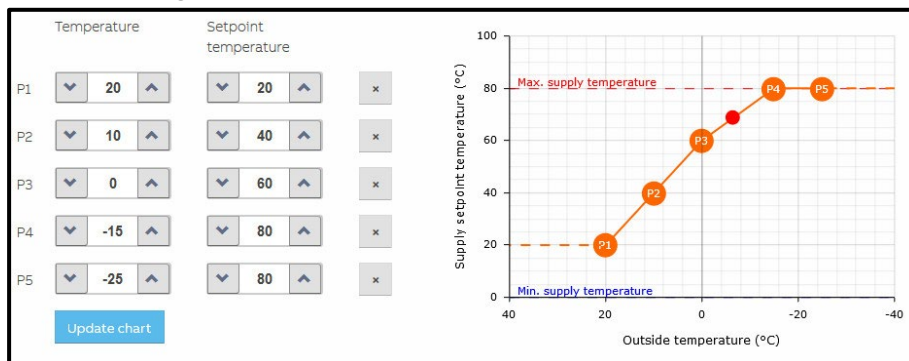

If the supply setpoint temperature is calculated based on the weather and in the ASM settings the *Custom* option is selected for the *Calculation formula* parameter, you can change the curve on the web user interface by specifying the points. The points from the ASM settings parameterized are used as the initial values.

The settings on the web user interface always apply. The parameters set in the ASM settings are overwritten and only become active again on the reinstallation of the ASM.

# ABB i-bus<sup>®</sup> KNX Parameters

## 7.11 Cooling distribution circuit ASM

### 7.11.1 General

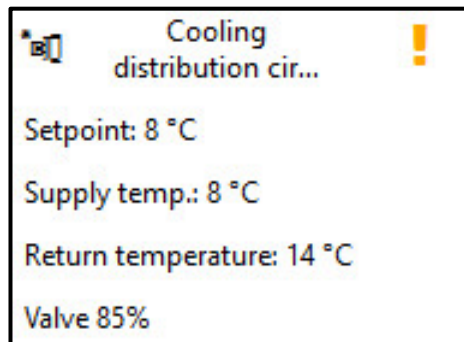

This application-specific automation module (ASM) calculates the supply setpoint temperature and sends the value calculated to a cooling distribution circuit controller (cooling circuit controller). The module also permits the display and operation via the module's web user interface of the cooling distribution circuit controller linked.

# ABB i-bus<sup>®</sup> KNX Parameters

7.11.2

## Settings

General	
Name	Cooling distribution circuit
Description	
Reinstall	<input type="checkbox"/>
Supply setpoint temperature	
Supply temperature control	<input checked="" type="checkbox"/>
Supply setpoint temperature source	Calculated weather compens... ▼
Min. supply temperature	3 ▲▼ °C
Switch off if no room demand	<input type="checkbox"/>
Custom supply temperature curve	Edit
Enable cooling circuit control based...	<input type="checkbox"/>
Pump	
Double pump	<input type="checkbox"/>
Override by WebUI	<input type="checkbox"/>
Pump display operating status	<input type="checkbox"/>
Pump display pump fault status	<input type="checkbox"/>
Display pump repair switch status	<input type="checkbox"/>
Valve	
Valve type	3-way valve (mixing valve) ▼
Status Valve purge	<input type="checkbox"/>
Valve override disable/enable	<input type="checkbox"/>

### General

You will find descriptions of the global settings (Name, Description, Reinstall, BACnet, WebUI) in [chapter 7.3, Global ASM settings](#).

# ABB i-bus<sup>®</sup> KNX Parameters

## **Supply setpoint temperature**

In this parameter window it is specified how the supply setpoint temperature for the cooling distribution circuit is calculated.

## **Supply temperature control**

Options:            No (checkbox cleared)  
                      Yes (checkbox selected)

On the selection of the Yes option, the ASM calculates the supply setpoint temperature for the cooling distribution circuit and sends the value calculated to the cooling distribution circuit controller via the group object. Other parameters define how the calculation is undertaken.

Selection of Yes option:

Dependent parameter(s):

### **Supply setpoint temperature source**

Options:            ASM input socket  
                      WebUI Input  
                      BACnet input object  
                      Calculated weather compensated

This parameter determines how the supply setpoint temperature is determined for the cooling distribution circuit. This setpoint is sent to the cooling distribution circuit controller via the group object.

- *ASM input socket*: The supply setpoint temperature received via the input socket on the ASM is used. This is an ASM multiple socket on which the lowest value present is used.
- *WebUI Input*: The supply setpoint temperature is set on the web user interface for the ASM.
- *BACnet input object*: The supply setpoint temperature received via the BACnet object for the ASM is used.
- *Calculated weather compensated*: The module calculates the supply setpoint temperature currently required based on the outside temperature.

# ABB i-bus<sup>®</sup> KNX Parameters

Selection of *ASM input socket* or *BACnet input object* option:

Dependent parameter(s):

### **Supply setpoint temperature offset**

Options: 0...100 °C

An offset can be entered to compensate for the energy losses in the pipes. This value is always subtracted from the supply setpoint temperature and is limited by the *Min. supply temperature* parameter.

Selection of *WebUI Input* or *BACnet input object* option:

Dependent parameter(s):

### **Initial values**

### **Supply setpoint temperature**

Options: 0...10...100 °C

This parameter defines the supply setpoint temperature that is output after downloading the module. This value is output until a new value is entered on the web user interface or is written to the BACnet object. This value is limited by the *Min. supply temperature* parameter.

# ABB i-bus<sup>®</sup> KNX Parameters

Selection of *Calculated weather compensated* option:

Dependent parameter(s):

## Custom supply temperature curve

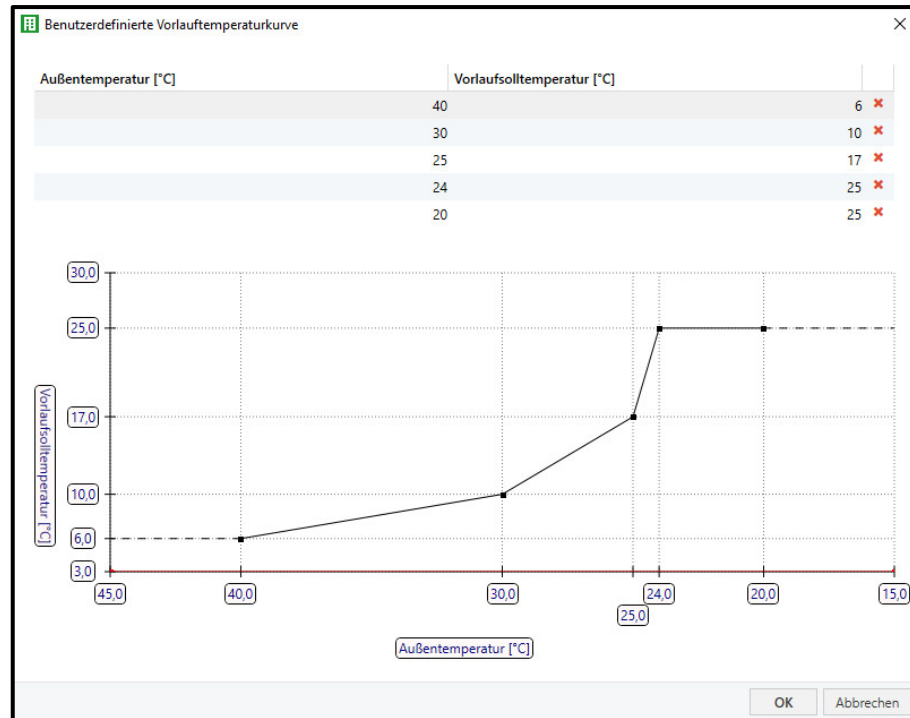

After you click the "Edit" button, a window opens where you can add a custom supply temperature curve by changing the supply setpoint temperature. The shape of the curve can be set as required by entering the points. The limit specified via the *Max. supply temperature* parameter is displayed on the chart as a red line.

This curve is used after downloading the module and can be modified via the web user interface for the module.

# ABB i-bus<sup>®</sup> KNX Parameters

## Min. supply temperature

Options: 0...3...100 °C

The supply setpoint temperature output by the module is limited using this parameter. This is a safety function that ensures a supply setpoint temperature too low for the cooling system is not output under any circumstances. For example, the supply setpoint temperature for cooling ceiling can be limited to minimum 14 °C.

## Switch off if no room demand

Options: No (checkbox cleared)  
Yes (checkbox selected)

With this function the module monitors the room control values and automatically switches on and off the cooling distribution circuit controller connected accordingly.

It is a prerequisite for this function that all control values from the room valves in the cooling distribution circuit are available and connected to the ASM input socket. There must therefore not be any conventional thermostats in the cooling distribution circuit.

This function is affected by the [Enable cooling circuit control based on ASM input socket](#) function. If both functions are activated, the [Enable cooling circuit control based on ASM input socket](#) has a higher priority.

Selection of Yes option:

Dependent parameter(s)

## Switch on if the room demand is higher than

Options: 0...10...100 %

The module sends a switch-on command to the cooling distribution circuit controller if the highest room control value present on the ASM input socket exceeds this value.

## Switch off if the room demand is equal to or less than

Options: 0...100 %

The module sends a switch-off command to the cooling distribution circuit controller if the highest room control value present on the ASM input socket is the same as or less than this value.

# ABB i-bus® KNX Parameters

## Enable cooling circuit control based on ASM input socket

Options: No (checkbox cleared)  
Yes (checkbox selected)

If this function is activated, an additional ASM input object for the control (Off/On) is activated; the value of this object is forwarded to the cooling distribution circuit controller via a group object that is then displayed.

If the [Switch off if no room demand](#) function is also activated, there is the following relationship:

<b>ASM input socket Control On/Off Heating/cooling distribution circuit controller control</b>	<b>Result of the Switch off if no room demand function</b>	<b>Result and output in the Control On/Off group object</b>
Off	Switched off	Off
On	Switched off	On
Off	Switched on	Off
On	Switched on	On



# ABB i-bus<sup>®</sup> KNX Parameters

## **Pump**

Settings for the cooling distribution circuit's pump.

## **Double pump**

Options:            No (checkbox cleared)  
                      Yes (checkbox selected)

This parameter specifies whether a double pump or a single pump is used in the cooling distribution circuit. The group objects, BACnet objects, ASM sockets and the depiction on the web user interface are adjusted to suit the setting.

## **Override by WebUI**

Options:            No (checkbox cleared)  
                      Yes (checkbox selected)

If this function is activated, the pump can be overridden via the web user interface. For this purpose additional group objects are displayed that must be connected to the cooling distribution circuit controller.

## **Pump display operating status**

Options:            No (checkbox cleared)  
                      Yes (checkbox selected)

If the pump outputs its operating status (Off/On), this status can be received by a group object via this function and output on the web user interface, in a BACnet object and on the ASM socket.

# ABB i-bus<sup>®</sup> KNX

## Parameters

### **Pump display pump fault status**

Options:            No (checkbox cleared)  
                      Yes (checkbox selected)

If the pump outputs its fault status, this status can be received by a group object via this function and output on the web user interface, in a BACnet object and on the ASM socket. The ASM only displays this state, there are no switching actions based on the fault status.

### **Display pump repair switch status**

Options:            No (checkbox cleared)  
                      Yes (checkbox selected)

If the pump has a repair switch and the contact position is output, this status can be received by a group object via this function and output on the web user interface, in a BACnet object and on the ASM socket.

# ABB i-bus<sup>®</sup> KNX Parameters

## **Valve**

Settings for the cooling distribution circuit valve.

### **Valve type**

Options:            3-way valve (mixing valve)  
                      2-way valve  
                      None

Setting for the valve type used in the cooling distribution circuit. This parameter affects the depiction on the web user interface.

Selection of *3-way valve (mixing valve)* or *2-way valve* option:

Dependent parameter(s)

### **Status Valve purge**

Options:            No (checkbox cleared)  
                      Yes (checkbox selected)

If this function is activated, the status of the valve purge can be received by a group object and output on the web user interface, in a BACnet object and on the ASM socket.

### **Valve override disable/enable**

Options:            No (checkbox cleared)  
                      Yes (checkbox selected)

If this function is activated, the valve can be overridden via the web user interface. For this purpose additional group objects are displayed that must be connected to the cooling distribution circuit controller.

# ABB i-bus® KNX Parameters

## 7.11.3

### Sockets

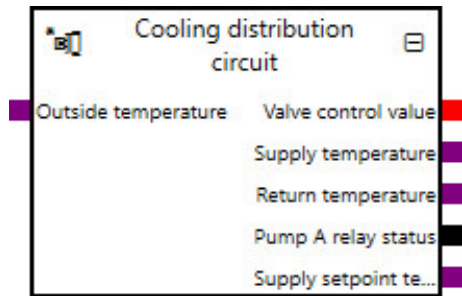

Overview of the ASM sockets for linking to other modules:

Type	Object name	Data type
Input	Control On/Off Heating/cooling distribution circuit controller control	1.001
Input	Supply setpoint temperature External specification	9.001
Input	Outside temperature	9.001
Input	Room control values	5.001
Output	Valve control value	5.001
Output	Supply temperature	9.001
Output	Return temperature	9.001
Output	Control On/Off	1.001
Output	Valve override disable/enable	1.003
Output	Valve override control value	5.001
Output	Status Valve purge	1.011
Output	Pump A operating status (Off/On)	1.011
Output	Pump A relay status	1.001
Output	Pump A fault	1.005
Output	Pump A repair switch status	1.011
Output	Pump A override disable/enable	1.003
Output	Pump A override value	1.001
Output	Pump B operating status (Off/On)	1.011
Output	Pump B relay status	1.001
Output	Pump B fault	1.005
Output	Pump B repair switch status	1.011
Output	Pump B override disable/enable	1.003
Output	Pump B override value	1.001
Output	Supply setpoint temperature	9.001
Output	Supply setpoint temperature External specification	9.001

# ABB i-bus<sup>®</sup> KNX Parameters

## Input sockets

Object name	Data type
<b>Control On/Off Heating/cooling distribution circuit controller control</b>	<b>DPT 1.001</b>
<p>This module has this input socket if the Yes option is selected for the <a href="#">Supply temperature control</a> parameter and the Yes option is selected for the <a href="#">Enable cooling circuit control based on ASM input socket</a> parameter.</p> <p>The control in the cooling distribution circuit controller connected can be switched on and off by another module via this input. This is a multiple input socket on which the input signals are linked via an OR operator.</p> <p>Signal value:       0 = Off                           1 = On</p>	
<b>Supply setpoint temperature External specification</b>	<b>DPT 9.001</b>
<p>This module has this input socket if the Yes option is selected for the <a href="#">Supply temperature control</a> parameter and the <i>ASM input socket</i> option is selected for the <a href="#">Supply setpoint temperature source</a> parameter.</p> <p>Specification of the supply setpoint temperature by another module. This value is output in the corresponding group objects to the cooling distribution circuit controller linked.</p> <div style="background-color: #f0f0f0; padding: 5px;"> <p> <b>Note</b></p> <p>The value can be affected by the <i>Min. supply temperature</i> and <i>Supply setpoint temperature offset</i> parameters in the module.</p> </div> <p>Signal value:       -273...670760 °C</p>	
<b>Outside temperature</b>	<b>DPT 9.001</b>
<p>This module has this input socket if the Yes option is selected for the <a href="#">Supply temperature control</a> parameter and the <i>Calculated weather compensated</i> option is selected for the <a href="#">Supply setpoint temperature source</a> parameter.</p> <p>Input for the outside temperature. Based on this value, the supply setpoint temperature is calculated by the module from the curve parameterized.</p> <p>Signal value:       -273...670760 °C</p>	
<b>Room control values</b>	<b>DPT 5.001</b>
<p>The module has this input socket if the Yes option is selected for the <a href="#">Switch off if no room demand</a> parameter.</p> <p>Input for the cooling control values (valve positions) for all rooms connected to the cooling distribution circuit. The module selects the highest value and uses this value for the <i>Switch off if no room demand</i> function.</p> <p>Signal value:       0...100%</p>	

# ABB i-bus<sup>®</sup> KNX Parameters

## Output sockets

Object name	Data type
<b>Valve control value</b>	<b>DPT 5.001</b>
<p>The module has this output socket if the <i>3-way valve (mixing valve)</i> option or the <i>2-way valve</i> option is selected for the <a href="#">Valve type</a> parameter.</p> <p>Outputs the valve control value for the cooling distribution circuit. This value is received from the cooling distribution circuit controller linked via the related module group object</p> <p>Signal value:           0...100%</p>	
<b>Supply temperature</b>	<b>DPT 9.001</b>
<p>Outputs the current supply temperature that is received via the related group object.</p> <p>Signal value:           -273...670760 °C</p>	
<b>Return temperature</b>	<b>DPT 9.001</b>
<p>Outputs the current return temperature that is received via the related group object.</p> <p>Signal value:           -273...670760 °C</p>	
<b>Control On/Off</b>	<b>DPT 1.001</b>
<p>The module has this output socket in the following conditions:</p> <ul style="list-style-type: none"> <li>• If the Yes option is selected for the <a href="#">Supply temperature control</a> parameter and the Yes option is selected for the <a href="#">Enable cooling circuit control based on ASM input socket</a> parameter.</li> <li>• If the Yes option is selected for the <a href="#">Switch off if no room demand</a> parameter.</li> </ul> <p>Outputs the status of the control that is sent to the cooling distribution circuit controller via the related group object. The state is dependent on the <a href="#">Enable cooling circuit control based on ASM input socket</a> and <a href="#">Switch off if no room demand</a> parameters.</p> <p>Signal value:           0 = Off                               1 = On</p>	

# ABB i-bus<sup>®</sup> KNX Parameters

Object name	Data type
<b>Valve override disable/enable</b>	<b>DPT 1.003</b>
<p>The module has this output socket if the 3-way valve (<i>mixing valve</i>) option or the 2-way valve option is selected for the <a href="#">Valve type</a> parameter and the Yes option is selected for the <a href="#">Valve override disable/enable</a> parameter.</p> <p>Outputs whether the override of the cooling distribution circuit's valve is active or inactive.</p> <p>Signal value:        0 = Disabled                           1 = Enabled</p>	
<b>Valve override control value</b>	<b>DPT 5.001</b>
<p>The module has this output socket if the 3-way valve (<i>mixing valve</i>) option or the 2-way valve option is selected for the <a href="#">Valve type</a> parameter and the Yes option is selected for the <a href="#">Valve override disable/enable</a> parameter.</p> <p>Outputs the value used to override the cooling distribution circuit's valve if the override is active</p> <p>Signal value:        0...100 %</p>	
<b>Status Valve purge</b>	<b>DPT 1.011</b>
<p>The module has this output socket if the 3-way valve (<i>mixing valve</i>) option or the 2-way valve option is selected for the <a href="#">Valve type</a> parameter and the Yes option is selected for the <a href="#">Status Valve purge</a> parameter.</p> <p>Outputs the status as to whether the cooling distribution circuit controller is actually undertaking a valve purge. This value is received from the cooling distribution circuit controller linked via the related module group object.</p> <p>Signal value:        0 = Inactive                           1 = Active</p>	
<b>Pump A operating status (Off/On)</b>	<b>DPT 1.011</b>
<p>The module has this output socket if the Yes option is selected for the <a href="#">Pump display operating status</a> parameter.</p> <p>Outputs the operating status (Off/On) provided by the pump. On pumps with their own control, this operating status can differ from the operating status of the cooling distribution circuit controller.</p> <p>Signal value:        0 = Inactive                           1 = Active</p>	
<b>Pump A relay status</b>	<b>DPT 1.001</b>
<p>Outputs the status of the pump from the cooling distribution circuit controller.</p> <p>Signal value:        0 = Off                           1 = On</p>	

# ABB i-bus<sup>®</sup> KNX Parameters

Object name	Data type
<b>Pump A fault</b>	<b>DPT 1.005</b>
<p>The module has this output socket if the Yes option is selected for the <a href="#">Pump display pump fault status</a> parameter.</p> <p>Outputs the fault status provided by the pump.</p> <p>Signal value:        0 = No alarm                           1 = Alarm</p>	
<b>Pump A repair switch status</b>	<b>DPT 1.011</b>
<p>The module has this output socket if the Yes option is selected for the <a href="#">Display pump repair switch status</a> parameter.</p> <p>Outputs the contact position provided by the pump repair switch.</p> <p>Signal value:        0 = Inactive                           1 = Active</p>	
<b>Pump A override disable/enable</b>	<b>DPT 1.003</b>
<p>The module has this output socket if the Yes option is selected for the <a href="#">Override by WebUI</a> parameter.</p> <p>Outputs whether the pump for the cooling distribution circuit is overridden.</p> <p>Signal value:        0 = Disabled                           1 = Enabled</p>	
<b>Pump A override value</b>	<b>DPT 1.001</b>
<p>The module has this output socket if the Yes option is selected for the <a href="#">Override by WebUI</a> parameter.</p> <p>Outputs the state with which the pump for the cooling distribution circuit is overridden if the pump override is active.</p> <p>Signal value:        0 = Off                           1 = On</p>	



# ABB i-bus<sup>®</sup> KNX Parameters

Object name	Data type
<b>Pump B operating status (Off/On)</b>	<b>DPT 1.011</b>
<p>The module has this output socket if the Yes option is selected for the <a href="#">Double pump</a> parameter and the Yes option is selected for the <a href="#">Pump display operating status</a> parameter.</p> <p>Outputs the operating status (Off/On) provided by the second pump. On pumps with their own control, this operating status can differ from the operating status of the cooling distribution circuit controller.</p> <p>.</p> <p>Signal value:        0 = Inactive                           1 = Active</p>	
<b>Pump B relay status</b>	<b>DPT 1.001</b>
<p>The module has this output socket if the Yes option is selected for the <a href="#">Double pump</a> parameter.</p> <p>Outputs the status of the second pump from the cooling distribution circuit controller.</p> <p>Signal value:        0 = Off                           1 = On</p>	
<b>Pump B fault</b>	<b>DPT 1.005</b>
<p>The module has this output socket if the Yes option is selected for the <a href="#">Double pump</a> parameter and the Yes option is selected for the <a href="#">Pump display pump fault status</a> parameter.</p> <p>Outputs the fault status provided by the second pump.</p> <p>Signal value:        0 = No alarm                           1 = Alarm</p>	
<b>Pump B repair switch status</b>	<b>DPT 1.011</b>
<p>The module has this output socket if the Yes option is selected for the <a href="#">Double pump</a> parameter and the Yes option is selected for the <a href="#">Display pump repair switch status</a> parameter.</p> <p>Outputs the contact position provided by the second pump repair switch.</p> <p>Signal value:        0 = Inactive                           1 = Active</p>	

# ABB i-bus<sup>®</sup> KNX

## Parameters

Object name	Data type
<b>Pump B override disable/enable</b>	<b>DPT 1.003</b>
<p>The module has this output socket if the Yes option is selected for the <a href="#">Double pump</a> parameter and the Yes option is selected for the <a href="#">Override by WebUI</a> parameter.</p> <p>Outputs whether the second pump for the cooling distribution circuit is overridden.</p> <p>Signal value:        0 = Disabled                           1 = Enabled</p>	
<b>Pump B override value</b>	<b>DPT 1.001</b>
<p>The module has this output socket if the Yes option is selected for the <a href="#">Double pump</a> parameter and the Yes option is selected for the <a href="#">Override by WebUI</a> parameter.</p> <p>Outputs the state with which the second pump for the cooling distribution circuit is overridden if the pump override is active.</p> <p>Signal value:        0 = Off                           1 = On</p>	
<b>Supply setpoint temperature</b>	<b>DPT 9.001</b>
<p>The module has this output socket if the Yes option is selected for the <a href="#">Supply temperature control</a> parameter.</p> <p>Outputs the current supply setpoint temperature as is sent by the module to the cooling distribution circuit controller via the related group object. The supply setpoint temperature output here is, depending on the setting, either calculated by this module based on the outside temperature, or specified via an ASM input socket or BACnet and also takes into account any possible override of the supply setpoint temperature via the web user interface.</p> <p>Signal value:        -273...670760 °C</p>	
<b>Supply setpoint temperature External specification</b>	<b>DPT 9.001</b>
<p>This module has this output socket if the Yes option is selected for the <a href="#">Supply temperature control</a> parameter and the <i>BACnet input object</i> option is selected for the <a href="#">Supply setpoint temperature source</a> parameter.</p> <p>Outputs the supply setpoint temperature specified via the BACnet object. This status does not take into account any possible override of the supply setpoint temperature via the web user interface.</p> <p>Signal value:        -273...670760 °C</p>	

# ABB i-bus<sup>®</sup> KNX Parameters

## 7.11.4

### Group objects

Object function	Name (can be changed separately)	Data point type (DPT)	Length	Flags						
				C	R	W	T	U	I	
Input: Valve control value	Cooling distribution circuit	5.001	1 byte	x		x	x			
Input: Supply temperature	Cooling distribution circuit	9.001	2 bytes	x		x	x			
Input: Return temperature	Cooling distribution circuit	9.001	2 bytes	x		x	x			
Output: Supply setpoint temperature	Cooling distribution circuit	9.001	2 bytes	x	x		x			
Input: Pump A relay status	Cooling distribution circuit	1.001	1 bit	x		x	x			
In-/Output: Valve override disable/enable	Cooling distribution circuit	1.003	1 bit	x	x	x	x			
In-/Output: Valve override control value	Cooling distribution circuit	5.001	1 byte	x	x	x	x			
Input: Status Valve purge	Cooling distribution circuit	1.011	1 bit	x		x	x			
Input: Pump A repair switch status	Cooling distribution circuit	1.011	1 bit	x		x	x			
Input: Pump A fault	Cooling distribution circuit	1.011	1 bit	x		x	x			
Input: Pump A operating status (Off/On)	Cooling distribution circuit	1.011	1 bit	x		x	x			
In-/Output: Pump A override disable/enable	Cooling distribution circuit	1.003	1 bit	x	x	x	x			
In-/Output: Pump A override value	Cooling distribution circuit	1.001	1 bit	x	x	x	x			
Input: Pump B fault	Cooling distribution circuit	1.011	1 bit	x		x	x			
In-/Output: Pump B override disable/enable	Cooling distribution circuit	1.003	1 bit	x	x	x	x			
In-/Output: Pump B override value	Cooling distribution circuit	1.001	1 bit	x	x	x	x			
Input: Pump B repair switch status	Cooling distribution circuit	1.011	1 bit	x		x	x			
Input: Pump B operating status (Off/On)	Cooling distribution circuit	1.011	1 bit	x		x	x			
Input: Pump B relay status	Cooling distribution circuit	1.001	1 bit	x		x	x			
Output: Control On/Off	Cooling distribution circuit	1.001	1 bit	x	x		x			

# ABB i-bus<sup>®</sup> KNX Parameters

Object function	Name (can be changed separately)	Data type	Flags
<b>Input: Valve control value</b>	<b>Cooling distribution circuit</b>	<b>1 byte DPT 5.001</b>	<b>C, W, T</b>
<p>The module has this group object if the 3-way valve (<i>mixing valve</i>) option or the 2-way valve option is selected for the <a href="#">Valve type</a> parameter.</p> <p>Input for the valve control value status from the cooling distribution circuit.</p> <p>Telegram value: 0...100 %</p>			
<b>Input: Supply temperature</b>	<b>Cooling distribution circuit</b>	<b>2 bytes DPT 9.001</b>	<b>C, W, T</b>
<p>Input for supply temperature measured in the cooling distribution circuit.</p> <p>Telegram value: -273...670760 °C</p>			
<b>Input: Return temperature</b>	<b>Cooling distribution circuit</b>	<b>2 bytes DPT 9.001</b>	<b>C, W, T</b>
<p>Input for return temperature measured in the cooling distribution circuit.</p> <p>Telegram value: -273...670760 °C</p>			
<b>Output: Supply setpoint temperature</b>	<b>Cooling distribution circuit</b>	<b>2 bytes DPT 9.001</b>	<b>C, R, T</b>
<p>Outputs the supply setpoint temperature calculated by the module as the value specified to the cooling distribution circuit controller.</p> <p>Telegram value: -273...670760 °C</p>			
<b>Input: Pump A relay status</b>	<b>Cooling distribution circuit</b>	<b>1 bit DPT 1.001</b>	<b>C, W, T</b>
<p>Input for the status of the pump from the cooling distribution circuit controller.</p> <p>Telegram value: 0 = Off 1 = On</p>			

# ABB i-bus<sup>®</sup> KNX Parameters

Object function	Name (can be changed separately)	Data type	Flags
<b>In-/Output: Valve override disable/enable</b>	<b>Cooling distribution circuit</b>	<b>1 bit DPT 1.003</b>	<b>C, R, W, T</b>
<p>The module has this group object if the <i>3-way valve (mixing valve)</i> option or the <i>2-way valve</i> option is selected for the <a href="#">Valve type</a> parameter and the <i>Yes</i> option is selected for the <a href="#">Valve override disable/enable</a> parameter.</p> <p>This object activates/deactivates the valve (mixing valve) override for the cooling distribution circuit controller.</p> <p>Telegram value:     0 = Disabled                           1 = Enabled</p>			
<b>In-/Output: Valve override control value</b>	<b>Cooling distribution circuit</b>	<b>1 byte DPT 5.001</b>	<b>C, R, W, T</b>
<p>The module has this group object if the <i>3-way valve (mixing valve)</i> option or the <i>2-way valve</i> option is selected for the <a href="#">Valve type</a> parameter and the <i>Yes</i> option is selected for the <a href="#">Valve override disable/enable</a> parameter.</p> <p>This object specifies the control value (valve position) used to override the valve for the cooling distribution circuit if the valve override is active.</p> <p>Telegram value:     0...100 %</p>			
<b>Input: Status Valve purge</b>	<b>Cooling distribution circuit</b>	<b>1 bit DPT 1.011</b>	<b>C, W, T</b>
<p>The module has this group object if the <i>3-way valve (mixing valve)</i> option or the <i>2-way valve</i> option is selected for the <a href="#">Valve type</a> parameter and the <i>Yes</i> option is selected for the <a href="#">Status Valve purge</a> parameter.</p> <p>Input for the status of the cooling distribution circuit controller as to whether a valve purge is currently in progress.</p> <p>Telegram value:     0 = Inactive                           1 = Active</p>			
<b>Input: Pump A repair switch status</b>	<b>Cooling distribution circuit</b>	<b>1 bit DPT 1.011</b>	<b>C, W, T</b>
<p>The module has this group object if the <i>Yes</i> option is selected for the <a href="#">Display pump repair switch status</a> parameter.</p> <p>The status of the repair switch for the pump can be received via this group object and evaluated by the device.</p> <p>Telegram value:     0 = Inactive                           1 = Active</p>			

# ABB i-bus<sup>®</sup> KNX Parameters

Object function	Name (can be changed separately)	Data type	Flags
<b>Input: Pump A fault</b>	<b>Cooling distribution circuit</b>	<b>1 bit DPT 1.011</b>	<b>C, W, T</b>
<p>The module has this group object if the Yes option is selected for the <a href="#">Pump display pump fault status</a> parameter.</p> <p>The fault state of the pump can be received via this group object and evaluated by the device</p> <p>Telegram value:    0 = Inactive                       1 = Active</p>			
<b>Input: Pump A operating status (Off/On)</b>	<b>Cooling distribution circuit</b>	<b>1 bit DPT 1.011</b>	<b>C, W, T</b>
<p>The module has this group object if the Yes option is selected for the <a href="#">Pump display operating status</a> parameter.</p> <p>Input for the operating status (Off/On) provided by the pump. On pumps with their own control, this operating status can differ from the operating status of the cooling distribution circuit controller.</p> <p>Telegram value:    0 = Inactive                       1 = Active</p>			
<b>In-/Output: Pump A override disable/enable</b>	<b>Cooling distribution circuit</b>	<b>1 bit DPT 1.003</b>	<b>C, R, W, T</b>
<p>The module has this group object if the Yes option is selected for the <a href="#">Override by WebUI</a> parameter.</p> <p>This object activates/deactivates the pump override for the cooling distribution circuit controller.</p> <p>Telegram value:    0 = Disabled                       1 = Enabled</p>			
<b>In-/Output: Pump A override value</b>	<b>Cooling distribution circuit</b>	<b>1 bit DPT 1.001</b>	<b>C, R, W, T</b>
<p>The module has this group object if the Yes option is selected for the <a href="#">Override by WebUI</a> parameter.</p> <p>This object specifies the state with which the pump for the cooling distribution circuit is overridden if the pump override is active.</p> <p>Telegram value:    0 = Off                       1 = On</p>			

# ABB i-bus<sup>®</sup> KNX Parameters

Object function	Name (can be changed separately)	Data type	Flags
<b>Input: Pump B fault</b>	<b>Cooling distribution circuit</b>	<b>1 bit DPT 1.011</b>	<b>C, W, T</b>
<p>The module has this group object if the Yes option is selected for the <a href="#">Double pump</a> parameter and the Yes option is selected for the <a href="#">Pump display pump fault status</a> parameter.</p> <p>The fault state of the second pump can be received via this group object and evaluated by the device</p> <p>Telegram value:     0 = Inactive                           1 = Active</p>			
<b>In-/Output: Pump B override disable/enable</b>	<b>Cooling distribution circuit</b>	<b>1 bit DPT 1.003</b>	<b>C, R, W, T</b>
<p>The module has this group object if the Yes option is selected for the <a href="#">Double pump</a> parameter and the Yes option is selected for the <a href="#">Override by WebUI</a> parameter.</p> <p>This object activates/deactivates the second pump override for the cooling distribution circuit controller.</p> <p>Telegram value:     0 = Disabled                           1 = Enabled</p>			
<b>In-/Output: Pump B override value</b>	<b>Cooling distribution circuit</b>	<b>1 bit DPT 1.001</b>	<b>C, R, W, T</b>
<p>The module has this group object if the Yes option is selected for the <a href="#">Double pump</a> parameter and the Yes option is selected for the <a href="#">Override by WebUI</a> parameter.</p> <p>This object specifies the state with which the second pump for the cooling distribution circuit is overridden if the second pump override is active.</p> <p>Telegram value:     0 = Off                           1 = On</p>			
<b>Input: Pump B repair switch status</b>	<b>Cooling distribution circuit</b>	<b>1 bit DPT 1.011</b>	<b>C, W, T</b>
<p>The module has this group object if the Yes option is selected for the <a href="#">Double pump</a> parameter and the Yes option is selected for the <a href="#">Display pump repair switch status</a> parameter.</p> <p>The status of the repair switch for the second pump can be received via this group object and evaluated by the device.</p> <p>Telegram value:     0 = Inactive                           1 = Active</p>			

# ABB i-bus<sup>®</sup> KNX Parameters

Object function	Name (can be changed separately)	Data type	Flags
<b>Input: Pump B operating status (Off/On)</b>	<b>Cooling distribution circuit</b>	<b>1 bit DPT 1.011</b>	<b>C, W, T</b>
<p>The module has this group object if the Yes option is selected for the <a href="#">Double pump</a> parameter and the Yes option is selected for the <a href="#">Pump display operating status</a> parameter.</p> <p>Input for the operating status (Off/On) provided by the second pump. On pumps with their own control, this operating status can differ from the operating status of the cooling distribution circuit controller.</p> <p>Telegram value:     0 = Inactive                           1 = Active</p>			
<b>Input: Pump B relay status</b>	<b>Cooling distribution circuit</b>	<b>1 bit DPT 1.001</b>	<b>C, W, T</b>
<p>The module has this group object if the Yes option is selected for the <a href="#">Double pump</a> parameter.</p> <p>Input for the status of the second pump from the cooling distribution circuit controller.</p> <p>Telegram value:     0 = Off                           1 = On</p>			
<b>Output: Control On/Off</b>	<b>Cooling distribution circuit</b>	<b>1 bit DPT 1.001</b>	<b>C, R, T</b>
<p>The module has this group object in the following conditions:</p> <ul style="list-style-type: none"> <li>• If the Yes option is selected for the <a href="#">Supply temperature control</a> parameter and the Yes option is selected for the <a href="#">Enable cooling circuit control based on ASM input socket</a> parameter.</li> <li>• If the Yes option is selected for the <a href="#">Switch off if no room demand</a> parameter.</li> </ul> <p>The cooling distribution circuit controller is switched on/off via this group object based on the calculations in the module.</p> <p>Telegram value:     0 = Off                           1 = On</p>			



# ABB i-bus<sup>®</sup> KNX Parameters

## 7.11.5

### BACnet objects

Type	Object name	Object type	Unit	COV send condition
Input	Cooling distribution circuit: Supply setpoint temperature External specification	Analog value	°C (62)	-
Output	Cooling distribution circuit: Return temperature	Analog value	°C (62)	1.0
Output	Cooling distribution circuit: Supply temperature	Analog value	°C (62)	1.0
Output	Cooling distribution circuit: Supply setpoint temperature status	Analog value	°C (62)	1.0
Output	Cooling distribution circuit: Outside temperature	Analog value	°C (62)	1.0
Output	Cooling distribution circuit: Supply setpoint temperature override status	Binary value	-	-
Output	Cooling distribution circuit: Supply setpoint temperature External specification	Analog value	°C (62)	1.0
Output	Cooling distribution circuit: Control On/Off	Binary value	-	-
Output	Cooling distribution circuit: Control On/Off override disable/enable	Binary value	-	-
Output	Cooling distribution circuit: Room control values	Analog value	% (98)	1.0
Output	Cooling distribution circuit: Pump A override disable/enable	Binary value	-	-
Output	Cooling distribution circuit: Pump A override value	Binary value	-	-
Output	Cooling distribution circuit: Pump A operating status (Off/On)	Binary value	-	-
Output	Cooling distribution circuit: Pump A relay status	Binary value	-	-
Output	Cooling distribution circuit: Pump A fault	Binary value	-	-
Output	Cooling distribution circuit: Pump A repair switch status	Binary value	-	-
Output	Cooling distribution circuit: Pump B override disable/enable	Binary value	-	-
Output	Cooling distribution circuit: Pump B override value	Binary value	-	-
Output	Cooling distribution circuit: Pump B operating status (Off/On)	Binary value	-	-
Output	Cooling distribution circuit: Pump B relay status	Binary value	-	-
Output	Cooling distribution circuit: Pump B fault	Binary value	-	-
Output	Cooling distribution circuit: Pump B repair switch status	Binary value	-	-
Output	Cooling distribution circuit: Valve control value	Analog value	% (98)	1.0
Output	Cooling distribution circuit: Valve override disable/enable	Binary value	-	-
Output	Cooling distribution circuit: Valve override control value	Analog value	% (98)	1.0
Output	Cooling distribution circuit: Status Valve purge	Binary value	-	-

# ABB i-bus<sup>®</sup> KNX

## Parameters

### BACnet input objects

Object name	Object type	Unit	COV send condition
<b>Cooling distribution circuit: Supply setpoint temperature External specification</b>	<b>Analog value</b>	<b>°C (62)</b>	<b>-</b>
<p>This module has this BACnet input object if the Yes option is selected for the <a href="#">Supply temperature control</a> parameter and the <i>BACnet input object</i> option is selected for the <a href="#">Supply setpoint temperature source</a> parameter.</p> <p>Input for the specification of the supply setpoint temperature. The value is sent by the module to the cooling distribution circuit controller via the related group object. This supply setpoint temperature specified via BACnet can be overridden manually on the web user interface.</p> <p>Signal value: -273...670760 °C</p>			

### BACnet output objects

Object name	Object type	Unit	COV send condition
<b>Cooling distribution circuit: Return temperature</b>	<b>Analog value</b>	<b>°C (62)</b>	<b>1.0</b>
<p>Outputs the current return temperature that is received via the related group object.</p> <p>Signal value: -273...670760 °C</p>			
<b>Cooling distribution circuit: Supply temperature</b>	<b>Analog value</b>	<b>°C (62)</b>	<b>1.0</b>
<p>Outputs the current supply temperature that is received via the related group object.</p> <p>Signal value: -273...670760 °C</p>			
<b>Cooling distribution circuit: Supply setpoint temperature status</b>	<b>Analog value</b>	<b>°C (62)</b>	<b>1.0</b>
<p>The module has this BACnet output object if the Yes option is selected for the <a href="#">Supply temperature control</a> parameter.</p> <p>Outputs the current supply setpoint temperature as is sent by this module to the cooling distribution circuit controller via the related group object. The supply setpoint temperature output here is, depending on the settings, either calculated by this module based on the outside temperature, or specified via an ASM input socket or BACnet and also takes into account any possible override of the supply setpoint temperature via the web user interface.</p> <p>Signal value: -273...670760 °C</p>			

# ABB i-bus<sup>®</sup> KNX Parameters

Object name	Object type	Unit	COV send condition
<b>Cooling distribution circuit: Outside temperature</b>	<b>Analog value</b>	<b>°C (62)</b>	<b>1.0</b>
<p>This module has this BACnet output object if the Yes option is selected for the <a href="#">Supply temperature control</a> parameter and the <i>Calculated weather compensated</i> option is selected for the <a href="#">Supply setpoint temperature source</a> parameter.</p> <p>Outputs the current outside temperature that is used by the module for the calculation.</p> <p>Signal value: -273...670760 °C</p>			
<b>Cooling distribution circuit: Supply setpoint temperature override status</b>	<b>Binary value</b>	-	-
<p>This module has this BACnet output object if the Yes option is selected for the <a href="#">Supply temperature control</a> parameter and the <i>ASM input socket</i> option, <i>BACnet input object</i> option or the <i>Calculated weather compensated</i> option is selected for the <a href="#">Supply setpoint temperature source</a> parameter.</p> <p>Outputs whether the supply setpoint temperature has been overridden via the web user interface.</p> <p>Signal value: 0 = Not overridden 1 = Overridden</p>			
<b>Cooling distribution circuit: Supply setpoint temperature External specification</b>	<b>Analog value</b>	<b>°C (62)</b>	<b>1.0</b>
<p>This module has this BACnet input object if the Yes option is selected for the <a href="#">Supply temperature control</a> parameter and the <i>ASM input socket</i> option is selected for the <a href="#">Supply setpoint temperature source</a> parameter.</p> <p>Outputs the supply setpoint temperature specified via the ASM input socket. This status does not take into account any possible override of the supply setpoint temperature via the web user interface.</p> <p>Signal value: -273...670760 °C</p>			
<b>Cooling distribution circuit: Control On/Off</b>	<b>Binary value</b>	-	-
<p>The module has this BACnet output object in the following conditions:</p> <ul style="list-style-type: none"> <li>• If the Yes option is selected for the <a href="#">Supply temperature control</a> parameter and the Yes option is selected for the <a href="#">Enable cooling circuit control based on ASM input socket</a> parameter.</li> <li>• If the Yes option is selected for the <a href="#">Switch off if no room demand</a> parameter.</li> </ul> <p>Outputs the status (Off/On) of the control that is sent to the cooling distribution circuit controller via the related group object. The state is dependent on the <i>Enable cooling circuit control based on ASM input socket</i> and <i>Switch off if no room demand</i> functions as well as override via the web user interface.</p> <p>Signal value: 0 = Off 1 = On</p>			

# ABB i-bus<sup>®</sup> KNX Parameters

Object name	Object type	Unit	COV send condition
<b>Cooling distribution circuit: Control On/Off override disable/enable</b>	<b>Binary value</b>	-	-
<p>The module has this BACnet output object in the following conditions:</p> <ul style="list-style-type: none"> <li>• If the Yes option is selected for the <a href="#">Supply temperature control</a> parameter and the Yes option is selected for the <a href="#">Enable cooling circuit control based on ASM input socket</a> parameter.</li> <li>• If the Yes option is selected for the <a href="#">Switch off if no room demand</a> parameter.</li> </ul> <p>Outputs whether the control (Off/On) for the cooling distribution circuit controller has been overridden via the web user interface.</p> <p>Signal value:        0 = Not overridden                           1 = Overridden</p>			
<b>Cooling distribution circuit: Room control values</b>	<b>Analog value</b>	<b>% (98)</b>	<b>1.0</b>
<p>The module has this BACnet output object if the Yes option is selected for the <a href="#">Switch off if no room demand</a> parameter.</p> <p>Outputs the highest room setpoint temperature that is present on the ASM input socket and that is used by the <i>Economy mode</i> and <i>Switch off if no room demand</i> functions.</p> <p>Signal value:        0...100 %</p>			
<b>Cooling distribution circuit: Pump A override disable/enable</b>	<b>Binary value</b>	-	-
<p>The module has this BACnet output object if the Yes option is selected for the <a href="#">Override by WebUI</a> parameter.</p> <p>Outputs whether the pump for the cooling distribution circuit is overridden.</p> <p>Signal value:        0 = Disabled                           1 = Enabled</p>			
<b>Cooling distribution circuit: Pump A override value</b>	<b>Binary value</b>	-	-
<p>The module has this BACnet output object if the Yes option is selected for the <a href="#">Override by WebUI</a> parameter.</p> <p>This object specifies the state with which the pump for the cooling distribution circuit is overridden if the pump override is active.</p> <p>Signal value:        0 = Off                           1 = On</p>			

# ABB i-bus<sup>®</sup> KNX Parameters

Object name	Object type	Unit	COV send condition
<b>Cooling distribution circuit: Pump A operating status (Off/On)</b>	<b>Binary value</b>	-	-
<p>The module has this BACnet output object if the Yes option is selected for the <a href="#">Pump display operating status</a> parameter.</p> <p>Outputs the operating status (Off/On) provided by the pump. On pumps with their own control, this operating status can differ from the operating status of the cooling distribution circuit controller.</p> <p>Signal value:       0 = Inactive                           1 = Active</p>			
<b>Cooling distribution circuit: Pump A relay status</b>	<b>Binary value</b>	-	-
<p>Outputs the status of the cooling distribution circuit controller's pump.</p> <p>Signal value:       0 = Off                           1 = On</p>			
<b>Cooling distribution circuit: Pump A fault</b>	<b>Binary value</b>	-	-
<p>The module has this BACnet output object if the Yes option is selected for the <a href="#">Pump display pump fault status</a> parameter.</p> <p>Outputs the fault status provided by the pump.</p> <p>Signal value:       0 = Inactive                           1 = Active</p>			
<b>Cooling distribution circuit: Pump A repair switch status</b>	<b>Binary value</b>	-	-
<p>The module has this BACnet output object if the Yes option is selected for the <a href="#">Display pump repair switch status</a> parameter.</p> <p>Outputs the contact position provided by the pump repair switch.</p> <p>Signal value:       0 = Inactive                           1 = Active</p>			
<b>Cooling distribution circuit: Pump B override disable/enable</b>	<b>Binary value</b>	-	-
<p>The module has this BACnet output object if the Yes option is selected for the <a href="#">Double pump</a> parameter and the Yes option is selected for the <a href="#">Override by WebUI</a> parameter.</p> <p>Outputs whether the second pump for the cooling distribution circuit is overridden.</p> <p>Signal value:       0 = Disabled                           1 = Enabled</p>			

# ABB i-bus<sup>®</sup> KNX Parameters

Object name	Object type	Unit	COV send condition
<b>Cooling distribution circuit: Pump B override value</b>	<b>Binary value</b>	-	-
<p>The module has this BACnet output object if the Yes option is selected for the <a href="#">Double pump</a> parameter and the Yes option is selected for the <a href="#">Override by WebUI</a> parameter.</p> <p>This object specifies the state with which the second pump for the cooling distribution circuit is overridden if the pump override is active.</p> <p>Signal value:       0 = Off                           1 = On</p>			
<b>Cooling distribution circuit: Pump B Operating Status (Off/On)</b>	<b>Binary value</b>	-	-
<p>The module has this BACnet output object if the Yes option is selected for the <a href="#">Double pump</a> parameter and the Yes option is selected for the <a href="#">Pump display operating status</a> parameter.</p> <p>Outputs the operating status (Off/On) provided by the second pump. On pumps with their own control, this operating status can differ from the operating status of the cooling distribution circuit controller.</p> <p>Signal value:       0 = Inactive                           1 = Active</p>			
<b>Cooling distribution circuit: Pump B relay status</b>	<b>Binary value</b>	-	-
<p>The module has this BACnet output object if the Yes option is selected for the <a href="#">Double pump</a> parameter.</p> <p>Outputs the status of the second pump from the cooling distribution circuit controller.</p> <p>Signal value:       0 = Off                           1 = On</p>			
<b>Cooling distribution circuit: Pump B fault</b>	<b>Binary value</b>	-	-
<p>The module has this BACnet output object if the Yes option is selected for the <a href="#">Double pump</a> parameter and the Yes option is selected for the <a href="#">Pump display pump fault status</a> parameter.</p> <p>Outputs the fault status provided by the second pump.</p> <p>Signal value:       0 = Inactive                           1 = Active</p>			

# ABB i-bus<sup>®</sup> KNX Parameters

Object name	Object type	Unit	COV send condition
<b>Cooling distribution circuit: Pump B repair switch status</b>	<b>Binary value</b>	-	-
<p>The module has this BACnet output object if the Yes option is selected for the <a href="#">Double pump</a> parameter and the Yes option is selected for the <a href="#">Display pump repair switch status</a> parameter.</p> <p>Outputs the contact position provided by the second pump repair switch.</p> <p>Signal value:       0 = Inactive                       1 = Active</p>			
<b>Cooling distribution circuit: Valve control value</b>	<b>Analog value</b>	<b>% (98)</b>	<b>1.0</b>
<p>The module has this BACnet output object if the <i>3-way valve (mixing valve)</i> option or the <i>2-way valve</i> option is selected for the <a href="#">Valve type</a> parameter.</p> <p>Outputs the valve control value for the cooling distribution circuit. This value is received from the cooling distribution circuit controller linked via the related module group object.</p> <p>Signal value:       0...100%</p>			
<b>Cooling distribution circuit: Valve override disable/enable</b>	<b>Binary value</b>	-	-
<p>The module has this BACnet output object if the <i>3-way valve (mixing valve)</i> option or the <i>2-way valve</i> option is selected for the <a href="#">Valve type</a> parameter and the Yes option is selected for the <a href="#">Valve override disable/enable</a> parameter.</p> <p>Outputs whether the override of the cooling distribution circuit's valve is active or inactive.</p> <p>Signal value:       0 = Disabled                       1 = Enabled</p>			
<b>Cooling distribution circuit: Valve override control value</b>	<b>Analog value</b>	<b>% (98)</b>	<b>1.0</b>
<p>The module has this BACnet output object if the <i>3-way valve (mixing valve)</i> option or the <i>2-way valve</i> option is selected for the <a href="#">Valve type</a> parameter and the Yes option is selected for the <a href="#">Valve override disable/enable</a> parameter.</p> <p>Outputs the value used to override the cooling distribution circuit's valve if the override is active.</p> <p>Signal value:       0...100 %</p>			
<b>Cooling distribution circuit: Status Valve purge</b>	<b>Binary value</b>	-	-
<p>The module has this BACnet output object if the <i>3-way valve (mixing valve)</i> option or the <i>2-way valve</i> option is selected for the <a href="#">Valve type</a> parameter and the Yes option is selected for the <a href="#">Status Valve purge</a> parameter.</p> <p>Outputs the status as to whether the cooling distribution circuit controller is actually undertaking a valve purge. This value is received from the cooling distribution circuit controller linked via the related module group object.</p> <p>Signal value:       0 = Inactive                       1 = Active</p>			

# ABB i-bus<sup>®</sup> KNX Parameters

7.11.6

WebUI

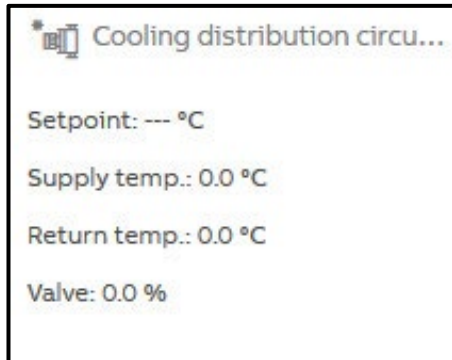

Open the detailed view of the ASM by clicking the ASM's tile.

The detailed view consists of two pages on which you make various settings in the individual sections.

## Distribution circuit page



This section shows the current operating status of the cooling distribution circuit controller linked via KNX.

If activated in the settings, the control by the cooling distribution circuit controller can be overridden by the "admin" and "expert" users via the web user interface. For this purpose the slider must be dragged to one of the two "Override" positions. The current state of the cooling distribution circuit controller continues to be displayed in "Auto" during the override.



# ABB i-bus<sup>®</sup> KNX Parameters

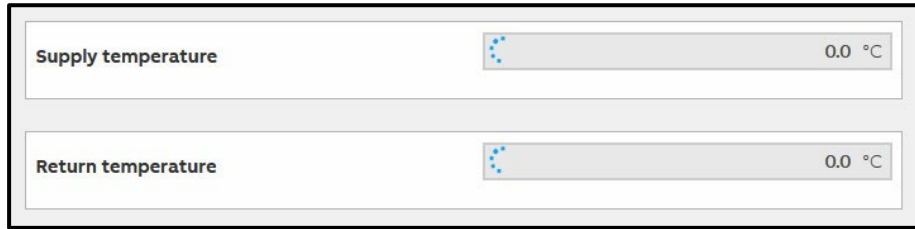

The screenshot shows a user interface with two rows. The first row is labeled "Supply temperature" and features a horizontal slider with a blue arrow pointing to the right, followed by a text box containing "0.0 °C". The second row is labeled "Return temperature" and features a similar horizontal slider with a blue arrow pointing to the right, followed by a text box containing "0.0 °C".

This section displays the current supply and return temperatures from the cooling distribution circuit controller linked via KNX.

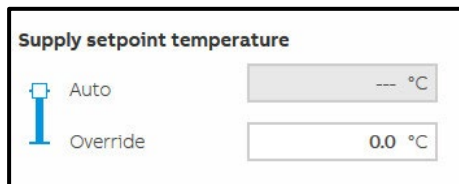

The screenshot shows a control interface titled "Supply setpoint temperature". On the left, there is a vertical slider with a blue handle. To the right of the slider are two options: "Auto" and "Override". The "Auto" option is currently selected, indicated by a blue vertical bar next to it. To the right of the "Auto" option is a text box containing "--- °C". To the right of the "Override" option is a text box containing "0.0 °C".

This section displays the current supply setpoint temperature calculated by this module. This temperature is sent via KNX to the cooling distribution circuit controller linked.

If activated in the settings, the supply setpoint temperature can be overridden by the "admin" and "expert" users via the web user interface. For this purpose the slider must be dragged to the "Override" position. A supply setpoint temperature continues to be calculated and displayed in "Auto" during the override. In this way you can see the value that will be used after changing the slider.

# ABB i-bus® KNX Parameters

<b>Pump A</b>		Status Pump relay:	<input type="button" value="Off"/>
<input type="checkbox"/> Auto		Pump operating status:	<input type="button" value="Inactive"/>
<input checked="" type="checkbox"/> Override: Off		Pump fault:	<input type="button" value="No alarm"/>
<input type="checkbox"/> Override: On		Repair switch:	<input type="button" value="Inactive"/>

This section displays the state of the pump from the cooling distribution circuit controller linked. If a double pump has been activated in the settings, a second section with the label "Pump B" appears. The settings described here for "Pump A" apply correspondingly to the section for "Pump B".

If activated in the settings, the pump for the cooling distribution circuit controller can be overridden by the "admin" and "expert" users via the web user interface. For this purpose the slider must be dragged to one of the two "Override" positions.

## Status Pump relay

Outputs the status of the pump from the cooling distribution circuit controller linked.

## Pump operating status

Outputs the operating status (Off/On) provided by the pump. On pumps with their own control, this operating status can differ from the operating status of the cooling distribution circuit controller.

## Pump fault

Outputs the fault status provided by the pump.

## Repair switch

Outputs the contact position provided by the pump repair switch.

# ABB i-bus<sup>®</sup> KNX Parameters

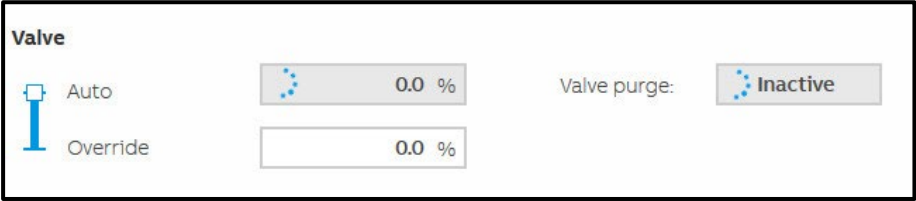

This section displays the valve position from the cooling distribution circuit controller linked via KNX. It is also indicated whether a valve purge is in progress.

If activated in the settings, the valve position can be overridden by the "admin" and "expert" users via the web user interface. For this purpose the slider must be dragged to the "Override" position. The status sent by the cooling distribution circuit controller continues to be displayed in "Auto" during the override.

# ABB i-bus<sup>®</sup> KNX Parameters

## **Supply temperature page**

On this page it is shown how the supply setpoint temperature is calculated. The settings on which the calculation is based can be changed.

The information displayed on this page may vary depending on which settings have been selected for the supply setpoint temperature calculation in the ASM settings.

<b>Status</b> Outside temperature	20.0 °C
--------------------------------------	---------

This section displays the current outside temperature that is used by the module for the calculation.

<b>Settings</b> Min. supply temperature	3.0 °C
--	--------

The parameter set in the ASM settings can be changed in this section via the web user interface. This is advantageous so that the settings can be adapted to the local situation during the operating of the system without renewed ETS programming.

The settings on the web user interface always apply. The parameters set in the ASM settings are overwritten and only become active again on the reinstallation of the ASM.

The supply setpoint temperature output by the module is limited using the *Min. supply temperature* parameter. This is a safety function that ensures a supply setpoint temperature too low for the cooling system is not output under any circumstances. For example, the supply setpoint temperature for cooling ceiling can be limited to minimum 14 °C.

# ABB i-bus<sup>®</sup> KNX Parameters

## Custom supply temperature curve chart

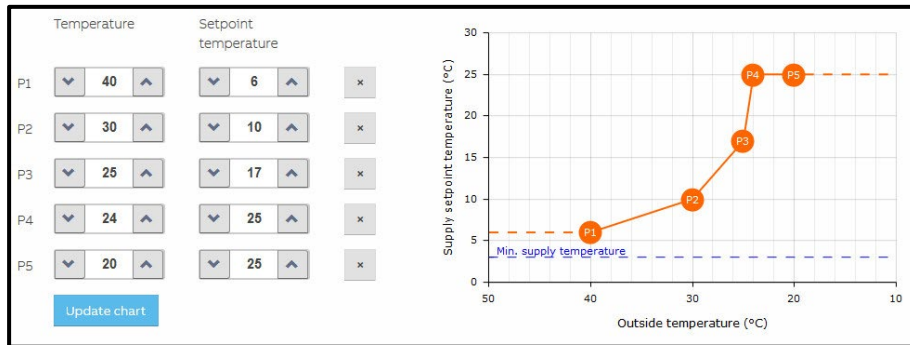

If the supply setpoint temperature is calculated based on the weather, you can change the curve on the web user interface by specifying the points. The points from the ASM settings parameterized are used as the initial values.

The settings on the web user interface always apply. The parameters set in the ASM settings are overwritten and only become active again on the reinstallation of the ASM.

# ABB i-bus<sup>®</sup> KNX Parameters

## 7.12 Chiller ASM

### 7.12.1 General

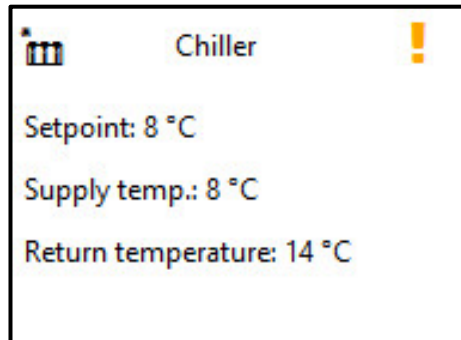

This application-specific automation module (ASM) calculates the supply setpoint temperature and sends the value calculated to a chiller linked via KNX. The module also allows the chiller to be displayed and operated via the module's web user interface.

# ABB i-bus<sup>®</sup> KNX Parameters

7.12.2

## Settings

<b>General</b>	
Name	Chiller
Description	
Reinstall	<input type="checkbox"/>
<b>Chiller</b>	
Enable chiller based on ASM input s...	<input type="checkbox"/>
Show operating status	<input type="checkbox"/>
Show fault status	<input type="checkbox"/>
<b>Supply setpoint temperature</b>	
Supply temperature control	<input checked="" type="checkbox"/>
Supply setpoint temperature source	Calculated weather compens... ▼
Min. supply temperature	3 <input type="text"/> °C
Switch off if no room demand	<input type="checkbox"/>
Custom supply temperature curve	Edit
<b>Pump</b>	
Pump	<input checked="" type="checkbox"/>
Override by WebUI	<input type="checkbox"/>
Pump display operating status	<input type="checkbox"/>
Pump display pump fault status	<input type="checkbox"/>
Display pump repair switch status	<input type="checkbox"/>

### General

You will find descriptions of the global settings (Name, Description, Reinstall, BACnet, WebUI) in [chapter 7.3, Global ASM settings](#).

# ABB i-bus<sup>®</sup> KNX Parameters

## Chiller

### **Enable chiller based on ASM input socket**

Options:            No (checkbox cleared)  
                      Yes (checkbox selected)

If this function is activated, an additional ASM input object for switching off/on the chiller is activated; the value of this object is then forwarded to a chiller via a group object that is then displayed.

If the [Switch off if no room demand](#) function is also activated, there is the following relationship:

<b>ASM input socket <i>Chiller On/Off</i></b>	<b>Result of the <i>Switch off if no room demand</i> function</b>	<b>Result and output in the <i>Chiller On/Off</i> group object</b>
Off	Switched off	Off
On	Switched off	On
Off	Switched on	Off
On	Switched on	On

### **Show operating status**

Options:            No (checkbox cleared)  
                      Yes (checkbox selected)

If the chiller outputs its operating status (Off/On), this status can be received by a group object via this function and output on the web user interface, in a BACnet object and on the ASM socket.

### **Show fault status**

Options:            No (checkbox cleared)  
                      Yes (checkbox selected)

If the chiller outputs its error status, this status can be received by a group object via this function and output on the web user interface, in a BACnet object and on the ASM socket.

The ASM only displays this state, there are no switching actions based on the fault status.



# ABB i-bus<sup>®</sup> KNX Parameters

## **Supply setpoint temperature**

In this parameter window it is specified how the supply setpoint temperature for the chiller is calculated.

### **Supply temperature control**

Options:           No (checkbox cleared)  
                      Yes (checkbox selected)

On the selection of the *Yes* option, the ASM calculates the supply setpoint temperature for the chiller and sends the value calculated to the chiller via the group object. Other parameters define how the calculation is undertaken.

Selection of *Yes* option:

Dependent parameter(s):

### **Supply setpoint temperature source**

Options:           ASM input socket  
                      WebUI Input  
                      BACnet input object  
                      Calculated weather compensated

This parameter determines how the supply setpoint temperature is determined for the chiller. This setpoint is sent to the chiller via the group object.

- *ASM input socket*: The supply setpoint temperature received via the input socket on the ASM is used. This is an ASM multiple socket on which the lowest value present is used.
- *WebUI Input*: The supply setpoint temperature is set on the web user interface for the ASM.
- *BACnet input object*: The supply setpoint temperature received via the BACnet object for the ASM is used.
- *Calculated weather compensated*: The module calculates the supply setpoint temperature currently required based on the outside temperature.

# ABB i-bus<sup>®</sup> KNX

## Parameters

Selection of *ASM input socket* or *BACnet input object* option:

Dependent parameter(s):

### **Supply setpoint temperature offset**

Options:        0...100 °C

An offset can be entered to compensate for the energy losses in the pipes. This value is always subtracted from the supply setpoint temperature and is limited by the *Min. supply temperature* parameter.

Selection of *WebUI Input* or *BACnet input object* option:

Dependent parameter(s):

### **Initial values**

### **Supply setpoint temperature**

Options:        0...10...100 °C

This parameter defines the supply setpoint temperature that is output after downloading the module. This value is output until a new value is entered on the web user interface or is written to the BACnet object. This value is limited by the *Min. supply temperature* parameter.

# ABB i-bus<sup>®</sup> KNX Parameters

Selection of *Calculated weather compensated* option:

Dependent parameter(s):

## Custom supply temperature curve

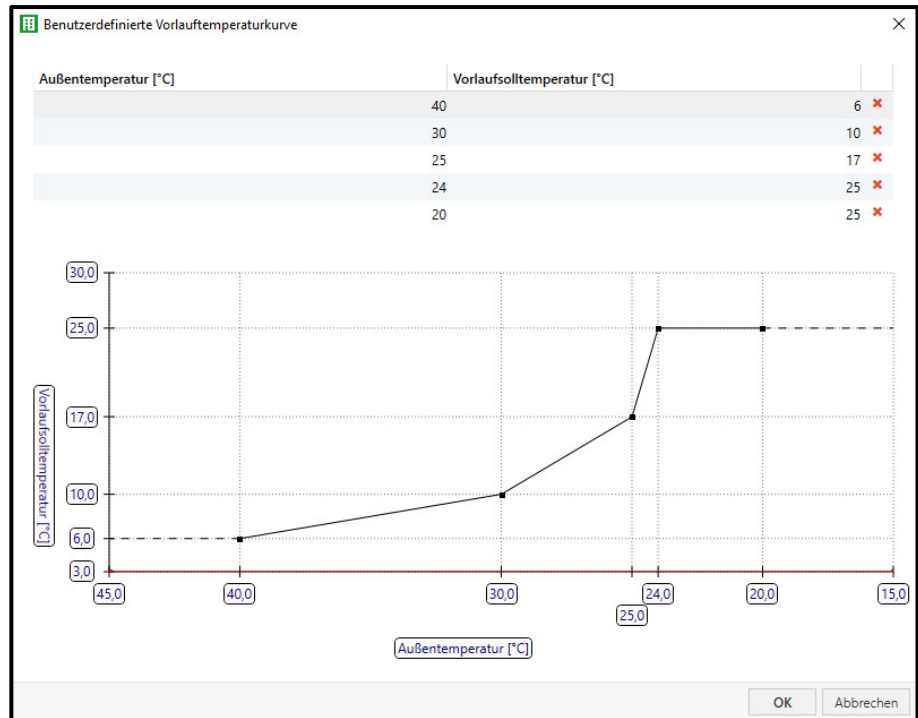

After you click the "Edit" button, a window opens where you can add a custom supply temperature curve by changing the supply setpoint temperature. The shape of the curve can be set as required by entering the points. The limit specified via the *Max. supply temperature* parameter is displayed on the chart as a red line.

This curve is used after downloading the module and can be modified via the web user interface for the module.

# ABB i-bus<sup>®</sup> KNX

## Parameters

### Min. supply temperature

Options: 0...3...100 °C

The supply setpoint temperature output by the module is limited using this parameter. This is a safety function that ensures a supply setpoint temperature too low for the cooling system is not output under any circumstances. For example, the supply setpoint temperature for cooling ceiling can be limited to minimum 14 °C.

### Switch off if no room demand

Options: No (checkbox cleared)  
Yes (checkbox selected)

With this function the module monitors the room control values and automatically switches on and off the chiller connected accordingly.

It is a prerequisite for this function that all control values from the room valves in the cooling system are available and connected to the ASM input socket. There must therefore not be any conventional thermostats in the cooling system.

This function is affected by the [Enable chiller based on ASM input socket](#) function. If both functions are activated, the *Enable chiller based on ASM input socket* has a higher priority.

Selection of Yes option:

Dependent parameter(s)

### Switch on if the room demand is higher than

Options: 0...10...100 %

The module sends a switch-on command to the chiller if the highest room control value present on the ASM input socket exceeds this value.

### Switch off if the room demand is equal to or less than

Options: 0...100 %

The module sends a switch-off command to the chiller if the highest room control value present on the ASM input socket is the same as or less than this value.

# ABB i-bus<sup>®</sup> KNX Parameters

## **Pump**

Settings for the chiller's pump.

## **Pump**

Options:            No (checkbox cleared)  
                      Yes (checkbox selected)

This parameter specifies whether a pump is used in the cooling system. The group objects, BACnet objects, ASM sockets and the depiction on the web user interface are adjusted to suit the setting.

## **Override by WebUI**

Options:            No (checkbox cleared)  
                      Yes (checkbox selected)

If this function is activated, the pump can be overridden via the web user interface. For this purpose additional group objects are displayed that must be connected to the chiller.

## **Pump display operating status**

Options:            No (checkbox cleared)  
                      Yes (checkbox selected)

If the pump outputs its operating status (Off/On), this status can be received by a group object via this function and output on the web user interface, in a BACnet object and on the ASM socket.

# ABB i-bus<sup>®</sup> KNX

## Parameters

### **Pump display pump fault status**

Options:            No (checkbox cleared)  
                      Yes (checkbox selected)

If the pump outputs its fault status, this status can be received by a group object via this function and output on the web user interface, in a BACnet object and on the ASM socket. The ASM only displays this state, there are no switching actions based on the fault status.

### **Display pump repair switch status**

Options:            No (checkbox cleared)  
                      Yes (checkbox selected)

If the pump has a repair switch and the contact position is output, this status can be received by a group object via this function and output on the web user interface, in a BACnet object and on the ASM socket.

# ABB i-bus<sup>®</sup> KNX Parameters

## 7.12.3

### Sockets

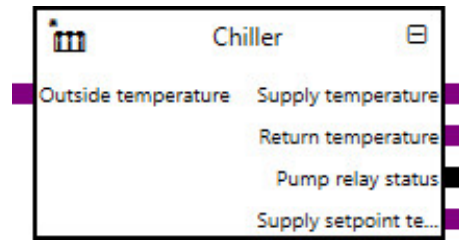

Overview of the ASM sockets for linking to other modules:

Type	Object name	Data type
Input	Chiller operating status	1.001
Input	Supply setpoint temperature External specification	9.001
Input	Outside temperature	9.001
Input	Room control values	5.001
Output	Supply temperature	9.001
Output	Return temperature	9.001
Output	Chiller On/Off	1.001
Output	Pump operating status (Off/On)	1.011
Output	Pump relay status	1.001
Output	Pump fault	1.005
Output	Pump repair switch status	1.011
Output	Pump override disable/enable	1.003
Output	Pump override value	1.001
Output	Supply setpoint temperature	9.001
Output	Supply setpoint temperature External specification	9.001
Output	Chiller operating status	1.001
Output	Chiller fault status	1.001

# ABB i-bus<sup>®</sup> KNX Parameters

## Input sockets

Object name	Data type
<b>Chiller operating status</b>	<b>DPT 1.001</b>
<p>This module has this input socket if the <b>Yes</b> option is selected for the <a href="#">Supply temperature control</a> parameter and the <b>Yes</b> option is selected for the <a href="#">Enable chiller based on ASM input socket</a> parameter.</p> <p>The control in the chiller connected can be switched on and off by another module via this input. This is a multiple input socket on which the input signals are linked via an OR operator.</p> <p>Signal value:           0 = Off                               1 = On</p>	
<b>Supply setpoint temperature External specification</b>	<b>DPT 9.001</b>
<p>This module has this input socket if the <b>Yes</b> option is selected for the <a href="#">Supply temperature control</a> parameter and the <i>ASM input socket</i> option is selected for the <a href="#">Supply setpoint temperature source</a> parameter.</p> <p>Specification of the supply setpoint temperature by another module. This value is output in the corresponding group objects to the chiller linked.</p> <div style="background-color: #f0f0f0; padding: 5px;"> <p> <b>Note</b></p> <p>The value can be affected by the <i>Min. supply temperature</i> and <i>Supply setpoint temperature offset</i> parameters in the module.</p> </div> <p>Signal value:           -273...670760 °C</p>	
<b>Outside temperature</b>	<b>DPT 9.001</b>
<p>This module has this input socket if the <b>Yes</b> option is selected for the <a href="#">Supply temperature control</a> parameter and the <i>Calculated weather compensated</i> option is selected for the <a href="#">Supply setpoint temperature source</a> parameter.</p> <p>Input for the outside temperature. Based on this value, the supply setpoint temperature is calculated by the module from the curve parameterized.</p> <p>Signal value:           -273...670760 °C</p>	
<b>Room control values</b>	<b>DPT 5.001</b>
<p>The module has this input socket if the <b>Yes</b> option is selected for the <a href="#">Switch off if no room demand</a> parameter.</p> <p>Input for the cooling control values (valve positions) for all rooms connected to the chiller. The module selects the highest value and uses this value for the <i>Switch off if no room demand</i> function.</p> <p>Signal value:           0...100%</p>	



# ABB i-bus<sup>®</sup> KNX Parameters

## Output sockets

Object name	Data type
<b>Supply temperature</b>	<b>DPT 9.001</b>
Outputs the current supply temperature that is received via the related group object.	
Signal value:           -273...670760 °C	
<b>Return temperature</b>	<b>DPT 9.001</b>
Outputs the current return temperature that is received via the related group object.	
Signal value:           -273...670760 °C	
<b>Chiller On/Off</b>	<b>DPT 1.001</b>
The module has this output socket in the following conditions:	
<ul style="list-style-type: none"> <li>• If the Yes option is selected for the <a href="#">Supply temperature control</a> parameter and the Yes option is selected for the <a href="#">Enable chiller based on ASM input socket</a> parameter.</li> <li>• If the Yes option is selected for the <a href="#">Switch off if no room demand</a> parameter.</li> </ul>	
Outputs the on/off status of the chiller that is sent to the chiller via the related group object. The state is dependent on the <a href="#">Enable chiller based on ASM input socket</a> and <a href="#">Switch off if no room demand</a> parameters.	
Signal value:           0 = Off 1 = On	
<b>Pump operating status (Off/On)</b>	<b>DPT 1.011</b>
The module has this output socket if the Yes option is selected for the <a href="#">Pump display operating status</a> parameter.	
Outputs the operating status (Off/On) provided by the pump. On pumps with their own control, this operating status can differ from the operating status of the chiller.	
Signal value:           0 = Inactive 1 = Active	
<b>Pump relay status</b>	<b>DPT 1.001</b>
Outputs the status of the pump from the chiller.	
Signal value:           0 = Off 1 = On	

# ABB i-bus<sup>®</sup> KNX Parameters

Object name	Data type
<b>Pump fault</b>	<b>DPT 1.005</b>
<p>The module has this output socket if the Yes option is selected for the <a href="#">Pump display pump fault status</a> parameter.</p> <p>Outputs the fault status provided by the pump.</p> <p>Signal value:        0 = No alarm                           1 = Alarm</p>	
<b>Pump repair switch status</b>	<b>DPT 1.011</b>
<p>The module has this output socket if the Yes option is selected for the <a href="#">Display pump repair switch status</a> parameter.</p> <p>Outputs the contact position provided by the pump repair switch.</p> <p>Signal value:        0 = Inactive                           1 = Active</p>	
<b>Pump override disable/enable</b>	<b>DPT 1.003</b>
<p>The module has this output socket if the Yes option is selected for the <a href="#">Override by WebUI</a> parameter.</p> <p>Outputs whether the pump for the chiller is overridden.</p> <p>Signal value:        0 = Disabled                           1 = Enabled</p>	
<b>Pump override value</b>	<b>DPT 1.001</b>
<p>The module has this output socket if the Yes option is selected for the <a href="#">Override by WebUI</a> parameter.</p> <p>Outputs the state with which the pump for the chiller is overridden if the pump override is active.</p> <p>Signal value:        0 = Off                           1 = On</p>	

# ABB i-bus<sup>®</sup> KNX Parameters

Object name	Data type
<b>Supply setpoint temperature</b>	<b>DPT 9.001</b>
<p>The module has this output socket if the Yes option is selected for the <a href="#">Supply temperature control</a> parameter.</p> <p>Outputs the current supply setpoint temperature as is sent by the module to the chiller via the related group object. The supply setpoint temperature output here is, depending on the setting, either calculated by this module based on the outside temperature, or specified via an ASM input socket or BACnet and also takes into account any possible override of the supply setpoint temperature via the web user interface.</p> <p>Signal value:           -273...670760 °C</p>	
<b>Supply setpoint temperature External specification</b>	<b>DPT 9.001</b>
<p>This module has this output socket if the Yes option is selected for the <a href="#">Supply temperature control</a> parameter and the <i>BACnet input object</i> option is selected for the <a href="#">Supply setpoint temperature source</a> parameter.</p> <p>Outputs the supply setpoint temperature specified via the BACnet object. This status does not take into account any possible override of the supply setpoint temperature via the web user interface.</p> <p>Signal value:           -273...670760 °C</p>	
<b>Chiller operating status</b>	<b>DPT 1.001</b>
<p>The module has this output socket if the Yes option is selected for the <a href="#">Show operating status</a> parameter.</p> <p>Outputs the operating status (Off/On) provided by the chiller. Due to the control integrated into the chiller, this status may differ from the operating status specified by this module.</p> <p>Signal value:           0 = Off                           1 = On</p>	
<b>Chiller fault status</b>	<b>DPT 1.001</b>
<p>The module has this output socket if the Yes option is selected for the <a href="#">Show fault status</a> parameter.</p> <p>Outputs the fault status provided by the chiller.</p> <p>Signal value:           0 = Off                           1 = On</p>	

# ABB i-bus<sup>®</sup> KNX Parameters

## 7.12.4

### Group objects

Object function	Name (can be changed separately)	Data point type (DPT)	Length	Flags						
				C	R	W	T	U	I	
Input: Supply temperature	Chiller	9.001	2 bytes	x		x	x			
Input: Return temperature	Chiller	9.001	2 bytes	x		x	x			
Output: Supply setpoint temperature	Chiller	9.001	2 bytes	x	x		x			
Input: Pump relay status	Chiller	1.001	1 bit	x		x	x			
Input: Pump repair switch status	Chiller	1.011	1 bit	x		x	x			
Input: Pump fault	Chiller	1.011	1 bit	x		x	x			
Input: Pump operating status (Off/On)	Chiller	1.011	1 bit	x		x	x			
In-/Output: Pump override disable/enable	Chiller	1.003	1 bit	x	x	x	x			
In-/Output: Pump override value	Chiller	1.001	1 bit	x	x	x	x			
Output: Chiller On/Off	Chiller	1.001	1 bit	x	x		x			
Input: Chiller operating status	Chiller	1.011	1 bit	x		x	x			
Input: Chiller fault status	Chiller	1.011	1 bit	x		x	x			

# ABB i-bus<sup>®</sup> KNX Parameters

Object function	Name (can be changed separately)	Data type	Flags
<b>Input: Supply temperature</b>	<b>Chiller</b>	<b>2 bytes DPT 9.001</b>	<b>C, W, T</b>
Input for supply temperature measured in the chiller. Telegram value: -273...670760 °C			
<b>Input: Return temperature</b>	<b>Chiller</b>	<b>2 bytes DPT 9.001</b>	<b>C, W, T</b>
Input for return temperature measured in the chiller. Telegram value: -273...670760 °C			
<b>Output: Supply setpoint temperature</b>	<b>Chiller</b>	<b>2 bytes DPT 9.001</b>	<b>C, R, T</b>
Outputs the supply setpoint temperature calculated by the module as the value specified to the chiller. Telegram value: -273...670760 °C			
<b>Input: Pump relay status</b>	<b>Chiller</b>	<b>1 bit DPT 1.001</b>	<b>C, W, T</b>
Input for the status of the pump from the chiller. Telegram value: 0 = Off 1 = On			
<b>Input: Pump repair switch status</b>	<b>Chiller</b>	<b>1 bit DPT 1.011</b>	<b>C, W, T</b>
The module has this group object if the Yes option is selected for the <a href="#">Display pump repair switch status</a> parameter. The status of the repair switch for the pump can be received via this group object and evaluated by the device. Telegram value: 0 = Inactive 1 = Active			

# ABB i-bus<sup>®</sup> KNX Parameters

Object function	Name (can be changed separately)	Data type	Flags
<b>Input: Pump fault</b>	<b>Chiller</b>	<b>1 bit DPT 1.011</b>	<b>C, W, T</b>
<p>The module has this group object if the Yes option is selected for the <a href="#">Pump display pump fault status</a> parameter.</p> <p>The fault state of the pump can be received via this group object and evaluated by the device</p> <p>Telegram value:    0 = Inactive                       1 = Active</p>			
<b>Input: Pump operating status (Off/On)</b>	<b>Chiller</b>	<b>1 bit DPT 1.011</b>	<b>C, W, T</b>
<p>The module has this group object if the Yes option is selected for the <a href="#">Pump display operating status</a> parameter.</p> <p>Input for the operating status (Off/On) provided by the pump. On pumps with their own control, this operating status can differ from the operating status of the chiller.</p> <p>Telegram value:    0 = Inactive                       1 = Active</p>			
<b>In-/Output: Pump override disable/enable</b>	<b>Chiller</b>	<b>1 bit DPT 1.003</b>	<b>C, R, W, T</b>
<p>The module has this group object if the Yes option is selected for the <a href="#">Override by WebUI</a> parameter.</p> <p>This object activates/deactivates the pump override for the chiller.</p> <p>Telegram value:    0 = Disabled                       1 = Enabled</p>			
<b>In-/Output: Pump override value</b>	<b>Chiller</b>	<b>1 bit DPT 1.001</b>	<b>C, R, W, T</b>
<p>The module has this group object if the Yes option is selected for the <a href="#">Override by WebUI</a> parameter.</p> <p>This object specifies the state with which the pump for the chiller is overridden if the pump override is active.</p> <p>Telegram value:    0 = Off                       1 = On</p>			

# ABB i-bus<sup>®</sup> KNX Parameters

Object function	Name (can be changed separately)	Data type	Flags
<b>Output: Chiller On/Off</b>	<b>Chiller</b>	<b>1 bit DPT 1.001</b>	<b>C, R, T</b>
<p>The module has this group object in the following conditions:</p> <ul style="list-style-type: none"> <li>• If the Yes option is selected for the <a href="#">Supply temperature control</a> parameter and the Yes option is selected for the <a href="#">Enable chiller based on ASM input socket</a> parameter.</li> <li>• If the Yes option is selected for the <a href="#">Switch off if no room demand</a> parameter.</li> </ul> <p>The chiller is switched on/off via this group object based on the calculations in the module.</p> <p>Telegram value:     0 = Off                           1 = On</p>			
<b>Input: Chiller operating status</b>	<b>Chiller</b>	<b>1 bit DPT 1.011</b>	<b>C, W, T</b>
<p>The module has this group object if the Yes option is selected for the <a href="#">Show operating status</a> parameter.</p> <p>Input for the operating status (Off/On) provided by the chiller. Due to the control integrated into the chiller, this status may differ from the operating status specified by this module.</p> <p>Telegram value:     0 = Inactive                           1 = Active</p>			
<b>Input: Chiller fault status</b>	<b>Chiller</b>	<b>1 bit DPT 1.011</b>	<b>C, W, T</b>
<p>The module has this group object if the Yes option is selected for the <a href="#">Show fault status</a> parameter.</p> <p>Input for the fault status provided by the chiller.</p> <p>Signal value:        0 = Inactive                           1 = Active</p>			

# ABB i-bus® KNX Parameters

## 7.12.5

### BACnet objects

Type	Object name	Object type	Unit	COV send condition
Input	Chiller: Supply setpoint temperature External specification	Analog value	°C (62)	-
Output	Chiller: Return temperature	Analog value	°C (62)	1.0
Output	Chiller: Supply temperature	Analog value	°C (62)	1.0
Output	Chiller: Supply setpoint temperature status	Analog value	°C (62)	1.0
Output	Chiller: Outside temperature	Analog value	°C (62)	1.0
Output	Chiller: Supply setpoint temperature override status	Binary value	-	-
Output	Chiller: Supply setpoint temperature External specification	Analog value	°C (62)	1.0
Output	Chiller: Chiller On/Off	Binary value	-	-
Output	Chiller: Control On/Off override disable/enable	Binary value	-	-
Output	Chiller: Chiller operating status	Binary value	-	-
Output	Chiller: Chiller fault status	Binary value	-	-
Output	Chiller: Room control values	Analog value	% (98)	1.0
Output	Chiller: Pump override disable/enable	Binary value	-	-
Output	Chiller: Pump override value	Binary value	-	-
Output	Chiller: Pump operating status (Off/On)	Binary value	-	-
Output	Chiller: Pump relay status	Binary value	-	-
Output	Chiller: Pump fault	Binary value	-	-
Output	Chiller: Pump repair switch status	Binary value	-	-

### BACnet input objects

Object name	Object type	Unit	COV send condition
<b>Chiller: Supply setpoint temperature External specification</b>	<b>Analog value</b>	<b>°C (62)</b>	<b>-</b>
<p>This module has this BACnet input object if the <a href="#">Yes</a> option is selected for the <a href="#">Supply temperature control</a> parameter and the <a href="#">BACnet input object</a> option is selected for the <a href="#">Supply setpoint temperature source</a> parameter.</p> <p>Input for the specification of the supply setpoint temperature. The value is sent by the module to the chiller via the related group object. This supply setpoint temperature specified via BACnet can be overridden manually on the web user interface.</p> <p>Signal value:           -273...670760 °C</p>			



# ABB i-bus<sup>®</sup> KNX Parameters

## **BACnet output objects**

Object name	Object type	Unit	COV send condition
<b>Chiller: Return temperature</b>	<b>Analog value</b>	<b>°C (62)</b>	<b>1.0</b>
Outputs the current return temperature that is received via the related group object.			
Signal value: -273...670760 °C			
<b>Chiller: Supply temperature</b>	<b>Analog value</b>	<b>°C (62)</b>	<b>1.0</b>
Outputs the current supply temperature that is received via the related group object.			
Signal value: -273...670760 °C			
<b>Chiller: Supply setpoint temperature status</b>	<b>Analog value</b>	<b>°C (62)</b>	<b>1.0</b>
The module has this BACnet output object if the Yes option is selected for the <a href="#">Supply temperature control</a> parameter.			
Outputs the current supply setpoint temperature as is sent by this module to the chiller via the related group object. The supply setpoint temperature output here is, depending on the settings, either calculated by this module based on the outside temperature, or specified via an ASM input socket or BACnet and also takes into account any possible override of the supply setpoint temperature via the web user interface.			
Signal value: -273...670760 °C			
<b>Chiller: Outside temperature</b>	<b>Analog value</b>	<b>°C (62)</b>	<b>1.0</b>
This module has this BACnet output object if the Yes option is selected for the <a href="#">Supply temperature control</a> parameter and the <a href="#">Calculated weather compensated</a> option is selected for the <a href="#">Supply setpoint temperature source</a> parameter.			
Outputs the current outside temperature that is used by the module for the calculation.			
Signal value: -273...670760 °C			
<b>Chiller: Supply setpoint temperature override status</b>	<b>Binary value</b>	<b>-</b>	<b>-</b>
This module has this BACnet output object if the Yes option is selected for the <a href="#">Supply temperature control</a> parameter and the <a href="#">ASM input socket</a> option, <a href="#">BACnet input object</a> option or the <a href="#">Calculated weather compensated</a> option is selected for the <a href="#">Supply setpoint temperature source</a> parameter.			
Outputs whether the supply setpoint temperature has been overridden via the web user interface.			
Signal value: 0 = Not overridden 1 = Overridden			

# ABB i-bus<sup>®</sup> KNX Parameters

Object name	Object type	Unit	COV send condition
<b>Chiller: Supply setpoint temperature External specification</b>	<b>Analog value</b>	<b>°C (62)</b>	<b>1.0</b>
<p>This module has this BACnet input object if the Yes option is selected for the <a href="#">Supply temperature control</a> parameter and the <a href="#">ASM input socket</a> option is selected for the <a href="#">Supply setpoint temperature source</a> parameter.</p> <p>Outputs the supply setpoint temperature specified via the ASM input socket. This status does not take into account any possible override of the supply setpoint temperature via the web user interface.</p> <p>Signal value:           -273...670760 °C</p>			
<b>Chiller: Chiller On/Off</b>	<b>Binary value</b>	-	-
<p>The module has this BACnet output object in the following conditions:</p> <ul style="list-style-type: none"> <li>• If the Yes option is selected for the <a href="#">Supply temperature control</a> parameter and the Yes option is selected for the <a href="#">Enable chiller based on ASM input socket</a> parameter.</li> <li>• If the Yes option is selected for the <a href="#">Switch off if no room demand</a> parameter.</li> </ul> <p>Outputs the on/off status of the chiller that is sent to the chiller via the related group object. The state is dependent on the <a href="#">Enable chiller based on ASM input socket</a> and <a href="#">Switch off if no room demand</a> functions as well as override via the web user interface.</p> <p>Signal value:           0 = Off                           1 = On</p>			
<b>Chiller: Control On/Off override disable/enable</b>	<b>Binary value</b>	-	-
<p>The module has this BACnet output object in the following conditions:</p> <ul style="list-style-type: none"> <li>• If the Yes option is selected for the <a href="#">Supply temperature control</a> parameter and the Yes option is selected for the <a href="#">Enable chiller based on ASM input socket</a> parameter.</li> <li>• If the Yes option is selected for the <a href="#">Switch off if no room demand</a> parameter.</li> </ul> <p>Outputs whether the control (Off/On) for the chiller has been overridden via the web user interface.</p> <p>Signal value:           0 = Not overridden                           1 = Overridden</p>			

# ABB i-bus<sup>®</sup> KNX Parameters

Object name	Object type	Unit	COV send condition
<b>Chiller: Chiller operating status</b>	<b>Binary value</b>	-	-
<p>The module has this BACnet output object if the Yes option is selected for the <a href="#">Show operating status</a> parameter.</p> <p>Outputs the operating status (Off/On) provided by the chiller. Due to the control integrated into the chiller, this status may differ from the operating status specified by this module.</p> <p>Signal value:        0 = Off                           1 = On</p>			
<b>Chiller: Chiller fault status</b>	<b>Binary value</b>	-	-
<p>The module has this BACnet output object if the Yes option is selected for the <a href="#">Show fault status</a> parameter.</p> <p>Outputs the fault status provided by the chiller.</p> <p>Signal value:        0 = Off                           1 = On</p>			
<b>Chiller: Room control values</b>	<b>Analog value</b>	<b>% (98)</b>	<b>1.0</b>
<p>The module has this BACnet output object if the Yes option is selected for the <a href="#">Switch off if no room demand</a> parameter.</p> <p>Outputs the highest room setpoint temperature that is present on the ASM input socket and that is used by the <i>Switch off if no room demand</i> function.</p> <p>Signal value:        0...100 %</p>			
<b>Chiller: Pump override disable/enable</b>	<b>Binary value</b>	-	-
<p>The module has this BACnet output object if the Yes option is selected for the <a href="#">Override by WebUI</a> parameter.</p> <p>Outputs whether the pump for the chiller is overridden.</p> <p>Signal value:        0 = Disabled                           1 = Enabled</p>			

# ABB i-bus® KNX Parameters

Object name	Object type	Unit	COV send condition
<b>Chiller: Pump override value</b>	<b>Binary value</b>	-	-
<p>The module has this BACnet output object if the Yes option is selected for the <a href="#">Override by WebUI</a> parameter.</p> <p>This object specifies the state with which the pump for the chiller is overridden if the pump override is active.</p> <p>Signal value:       0 = Off                           1 = On</p>			
<b>Chiller: Pump operating status (Off/On)</b>	<b>Binary value</b>	-	-
<p>The module has this BACnet output object if the Yes option is selected for the <a href="#">Pump display operating status</a> parameter.</p> <p>Outputs the operating status (Off/On) provided by the pump. On pumps with their own control, this operating status can differ from the operating status of the chiller.</p> <p>Signal value:       0 = Inactive                           1 = Active</p>			
<b>Chiller: Pump relay status</b>	<b>Binary value</b>	-	-
<p>Outputs the status of the chiller's pump.</p> <p>Signal value:       0 = Off                           1 = On</p>			
<b>Chiller: Pump fault</b>	<b>Binary value</b>	-	-
<p>The module has this BACnet output object if the Yes option is selected for the <a href="#">Pump display pump fault status</a> parameter.</p> <p>Outputs the fault status provided by the pump.</p> <p>Signal value:       0 = Inactive                           1 = Active</p>			
<b>Chiller: Pump repair switch status</b>	<b>Binary value</b>	-	-
<p>The module has this BACnet output object if the Yes option is selected for the <a href="#">Display pump repair switch status</a> parameter.</p> <p>Outputs the contact position provided by the pump repair switch.</p> <p>Signal value:       0 = Inactive                           1 = Active</p>			

# ABB i-bus<sup>®</sup> KNX Parameters

7.12.6

## WebUI

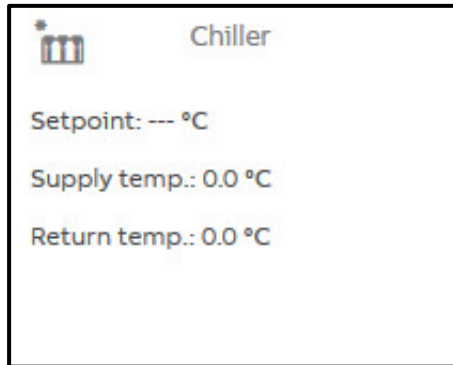

Open the detailed view of the ASM by clicking the ASM's tile.

The detailed view consists of two pages on which you make various settings in the individual sections.

### Chiller page



This section shows the current operating status of the chiller linked via KNX.

If activated in the settings, the control by the chiller can be overridden by the "admin" and "expert" users via the web user interface. For this purpose the slider must be dragged to one of the two "Override" positions. The current state of the chiller continues to be displayed in "Auto" during the override.

# ABB i-bus<sup>®</sup> KNX Parameters

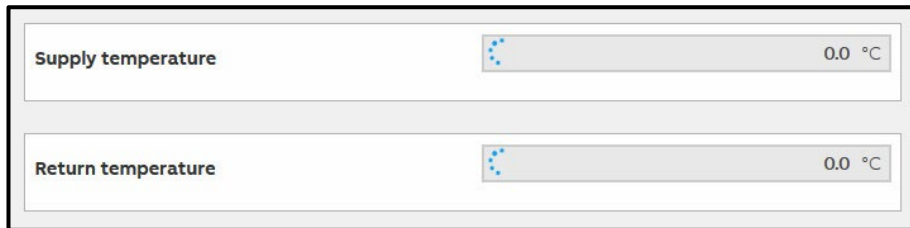

The screenshot shows two rows of data. The first row is labeled 'Supply temperature' and has a value of '0.0 °C'. The second row is labeled 'Return temperature' and also has a value of '0.0 °C'. Each row includes a small blue icon with a circular arrow to its left.

This section displays the current supply and return temperatures from the chiller linked via KNX.

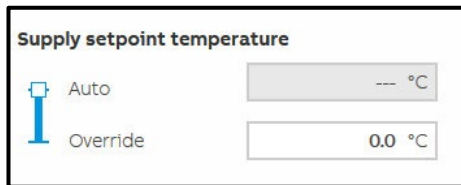

The screenshot shows a section titled 'Supply setpoint temperature'. It features a vertical slider control. The top position is labeled 'Auto' and shows a value of '--- °C'. The bottom position is labeled 'Override' and shows a value of '0.0 °C'. The slider is currently positioned at the 'Auto' level.

This section displays the current supply setpoint temperature calculated by this module. This temperature is sent via KNX to the chiller linked.

If activated in the settings, the supply setpoint temperature can be overridden by the "admin" and "expert" users via the web user interface. For this purpose the slider must be dragged to the "Override" position. A supply setpoint temperature continues to be calculated and displayed in "Auto" during the override. In this way you can see the value that will be used after changing the slider.

# ABB i-bus® KNX Parameters

<b>Pump</b>	<input type="checkbox"/> Auto	Status Pump relay:	<input type="button" value="Off"/>
	<input checked="" type="checkbox"/> Override: Off	Pump operating status:	<input type="button" value="Inactive"/>
	<input type="checkbox"/> Override: On	Pump fault:	<input type="button" value="No alarm"/>
		Repair switch:	<input type="button" value="Inactive"/>

This section displays the state of the pump from the chiller linked.

If activated in the settings, the pump for the chiller can be overridden by the "admin" and "expert" users via the web user interface. For this purpose the slider must be dragged to one of the two "Override" positions.

## Status Pump relay

Outputs the status of the pump from the chiller linked.

## Pump operating status

Outputs the operating status (Off/On) provided by the pump. On pumps with their own control, this operating status can differ from the operating status of the chiller.

## Pump fault

Outputs the fault status provided by the pump.

## Repair switch

Outputs the contact position provided by the pump repair switch.

# ABB i-bus<sup>®</sup> KNX Parameters



This section displays the state of the chiller linked.

## **Status**

Outputs the operating status provided by the chiller linked.

## **Pump fault**

Outputs the fault status provided by the chiller linked.



# ABB i-bus<sup>®</sup> KNX Parameters

## **Supply temperature page**

On this page it is shown how the supply setpoint temperature is calculated. The settings on which the calculation is based can be changed.

The information displayed on this page may vary depending on which settings have been selected for the supply setpoint temperature calculation in the ASM settings.

<b>Status</b> Outside temperature	20.0 °C
--------------------------------------	---------

This section displays the current outside temperature that is used by the module for the calculation.

<b>Settings</b> Min. supply temperature	3.0 °C
--	--------

The parameter set in the ASM settings can be changed in this section via the web user interface. This is advantageous so that the settings can be adapted to the local situation during the operating of the system without renewed ETS programming.

The settings on the web user interface always apply. The parameters set in the ASM settings are overwritten and only become active again on the reinstallation of the ASM.

The supply setpoint temperature output by the module is limited using the *Min. supply temperature* parameter. This is a safety function that ensures a supply setpoint temperature too low for the cooling system is not output under any circumstances. For example, the supply setpoint temperature for cooling ceiling can be limited to minimum 14 °C.

# ABB i-bus<sup>®</sup> KNX Parameters

## Custom supply temperature curve chart

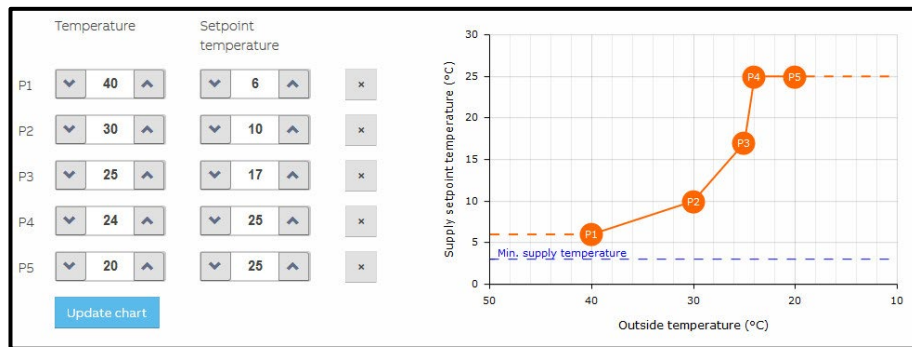

If the supply setpoint temperature is calculated based on the weather, you can change the curve on the web user interface by specifying the points. The points from the ASM settings parameterized are used as the initial values.

The settings on the web user interface always apply. The parameters set in the ASM settings are overwritten and only become active again on the reinstallation of the ASM.

# ABB i-bus<sup>®</sup> KNX Parameters

## 7.13 Heating/cooling changeover ASM

### 7.13.1 General

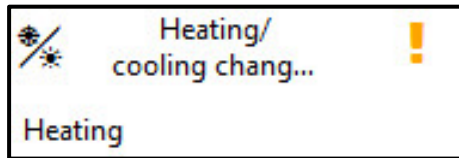

This application-specific automation module (ASM) selects the heating or cooling operating type currently required for a system with heating and cooling functions. Depending on the setting made, the operating type is calculated based on the outside temperature or on the supply temperature. The module outputs the current operating type on the KNX bus, on the ASM output socket and on BACnet.

### 7.13.2 Settings

<b>General</b>	
Name	Heating/cooling changeover
Description	
Reinstall	<input type="checkbox"/>
<b>Interfaces</b>	
Change over based on	Outside temperature ▼
Cooling if greater than	24.0 ▲▼ °C
Heating if less than	17.0 ▲▼ °C
<b>Initial values</b>	
Initial value	Heating ▼

#### General

You will find descriptions of the global settings (Name, Description, Reinstall, BACnet, WebUI) in [chapter 7.3, Global ASM settings](#).

# ABB i-bus<sup>®</sup> KNX

## Parameters

### Interfaces

#### **Change over based on**

Options:            Outside temperature  
                         Supply temperature

This parameter specifies the basis for the changeover between the heating and cooling operating type.

Selection of *Outside temperature* option:

Dependent parameter(s)

#### **Cooling if greater than**

Options:            -10...24...100 °C

The *cooling* operating type is activated as soon as the outside temperature at the ASM exceeds the value set here.

#### **Heating if less than**

Options:            -10...17...100 °C

The *heating* operating type is activated as soon as the outside temperature at the ASM drops below the value set here.

Selection of *Supply temperature* option:

Dependent parameter(s)

#### **Cooling if less than**

Options:            -10...15...100 °C

The *cooling* operating type is activated as soon as the supply temperature at the ASM drops below the value set here. This means that the chiller is activated and provides cooling medium.

#### **Heating if greater than**

Options:            -10...30...100 °C

The *heating* operating type is activated as soon as the supply temperature at the ASM exceeds the value set here. This means that the chiller is not active.

# ABB i-bus<sup>®</sup> KNX Parameters

## Initial values

### Initial value

Options:           Cooling  
                      Heating

On device start or after downloading the ASM, the appropriate operating type can be determined unambiguously if the outside temperature/supply temperature at the ASM exceeds or is below the changeover temperatures set above. If the outside temperature/supply temperature at the ASM is, however, between these two changeover temperatures, it is not possible to determine the operating type unambiguously. For this reason the operating type last active is used on a device start. After downloading the ASM, the operating type set here is used.

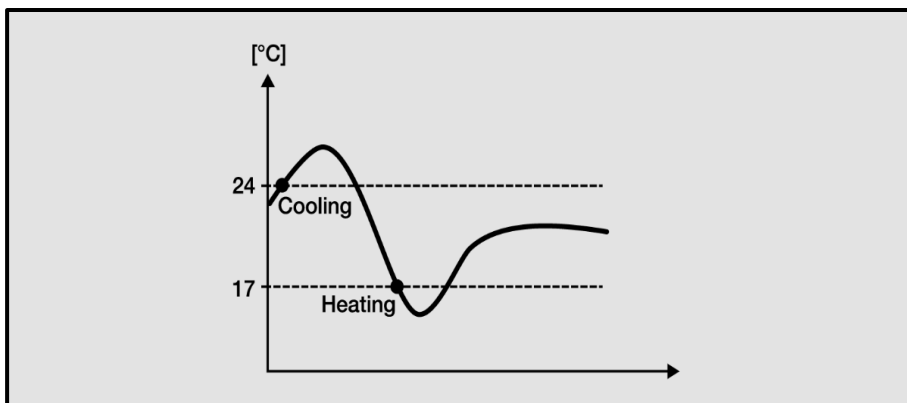

# ABB i-bus<sup>®</sup> KNX Parameters

7.13.3

## Sockets

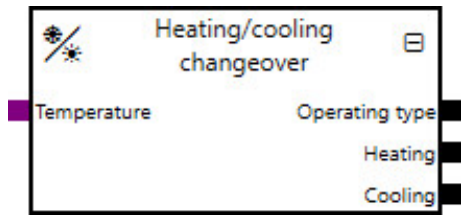

Overview of the ASM sockets for linking to other modules:

Type	Object name	Data type
Input	Temperature	9.001
Output	Operating type	1.100
Output	Heating	1.001
Output	Cooling	1.001

### Input sockets

Object name	Data type
<b>Temperature</b>	<b>DPT 9.001</b>
Either the outside temperature or the supply temperature must be connected to this input socket, depending on the setting selected above. The changeover between heating and cooling is undertaken based on the temperature present here.	
Signal value:	-273...670760 °C

### Output sockets

Object name	Data type
<b>Operating type</b>	<b>DPT 1.100</b>
Outputs the active operating type Signal value: 0 = Cooling 1 = Heating	
<b>Heating</b>	<b>DPT 1.001</b>
Outputs the state of the heating operating type. Signal value: 0 = Off 1 = On	
<b>Cooling</b>	<b>DPT 1.001</b>
Outputs the state of the cooling operating type. Signal value: 0 = Off 1 = On	

# ABB i-bus<sup>®</sup> KNX Parameters

## 7.13.4

### Group objects

Object function	Name (can be changed separately)	Data point type (DPT)	Length	Flags					
				C	R	W	T	U	I
Output: Operating type	Heating/cooling changeover	1.100	1 bit	x	x		x		
Output: Heating	Heating/cooling changeover	1.001	1 bit	x	x		x		
Output: Cooling	Heating/cooling changeover	1.001	1 bit	x	x		x		

Object function	Name (can be changed separately)	Data type	Flags
<b>Output: Operating type</b>	<b>Heating/cooling changeover</b>	<b>1 bit DPT 1.100</b>	<b>C, R, T</b>
<p>Outputs the active operating type. The value is sent on every change and then repeated every 30 minutes. The cycle time cannot be changed.</p> <p>Telegram value:    0 = Cooling                       1 = Heating</p>			
<b>Output: Heating</b>	<b>Heating/cooling changeover</b>	<b>1 bit DPT 1.001</b>	<b>C, R, T</b>
<p>Outputs the state of the heating operating type. The value is sent on every change and then repeated every 30 minutes. The cycle time cannot be changed.</p> <p>Telegram value:    0 = Off                       1 = On</p>			
<b>Output: Cooling</b>	<b>Heating/cooling changeover</b>	<b>1 bit DPT 1.001</b>	<b>C, R, T</b>
<p>Outputs the state of the heating operating type. The value is sent on every change and then repeated every 30 minutes. The cycle time cannot be changed.</p> <p>Telegram value:    0 = Off                       1 = On</p>			

# ABB i-bus<sup>®</sup> KNX Parameters

## 7.13.5 BACnet objects

### BACnet input objects

None

### BACnet output objects

Object name	Object type	Unit	COV send condition
<b>Heating/cooling changeover: Operating type</b>	<b>Binary value</b>	-	-
Outputs the active operating type.  Signal value:      0 = Cooling 1 = Heating			



# ABB i-bus<sup>®</sup> KNX Parameters

7.13.6

WebUI

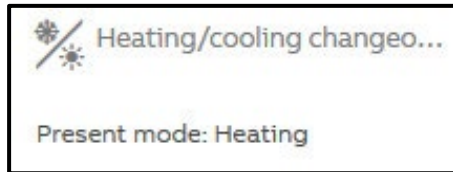

Open the detailed view of the ASM by clicking the ASM's tile.

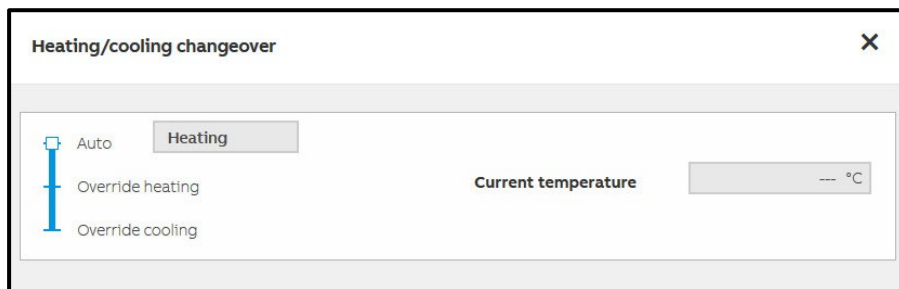

The operating type calculated is displayed on the web user interface. The outside temperature/supply temperature present at the module is also displayed.

The "admin" and "expert" users can override the current operating type. For the other users this field is dimmed and can therefore not be changed. The automatic calculation of the operating type continues to run during the override and the automatically calculated operating type is also displayed on the web user interface in "Auto". The operating type is only output in the group objects, on the ASM output sockets and in the BACnet objects after the override has been cleared by selecting "Auto".

The override is active until it is cleared again.

# ABB i-bus<sup>®</sup> KNX Parameters

## 7.14 Operating mode Scheduler WebUI ASM

### 7.14.1 General

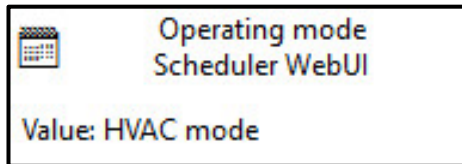

This application-specific automation module (ASM) is a timer for the HVAC operating mode (Comfort, Standby, Economy, Building Protection). The switching times are parametrized via the web user interface. Switching commands can be set to the minute for each weekday, and exceptions (e.g. for holidays) can be defined on a weekly, monthly and yearly basis.

The application controller outputs the switching command on the KNX bus, on the ASM output socket and on BACnet.

#### Note

It is essential the clock in the application controller is set to operate this module.

### 7.14.2 Settings

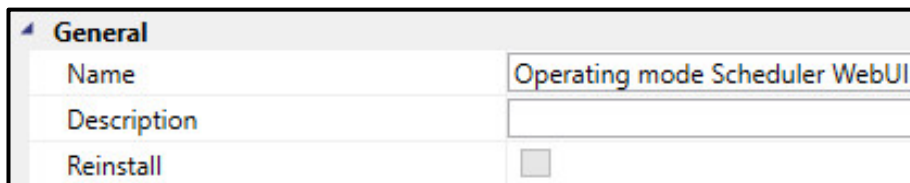

#### **General**

You will find descriptions of the global settings (Name, Description, Reinstall, BACnet, WebUI) in [chapter 7.3. Global ASM settings](#).

# ABB i-bus<sup>®</sup> KNX Parameters

## 7.14.3

### Sockets

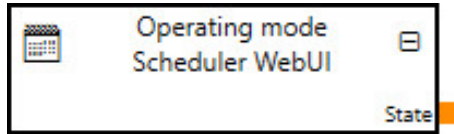

Overview of the ASM sockets for linking to other modules:

#### Input sockets

None

#### Output sockets

Object name	Data type
<b>State</b>	<b>DPT 20.102</b>
The current value, based on the scheduler, is output for the linking to other modules. Signal value:       1 = Comfort 2 = Standby 3 = Economy 4 = Building Protection	

## 7.14.4

### Group objects

Object function	Name (can be changed separately)	Data type	Flags
<b>Output: State</b>	<b>Operating mode Scheduler WebUI</b>	<b>1 byte DPT 20.102</b>	<b>C, R, T</b>
The current value, based on the scheduler, is output. Telegram value:    1 = Comfort 2 = Standby 3 = Economy 4 = Building Protection			

# ABB i-bus<sup>®</sup> KNX Parameters

## 7.14.5 BACnet objects

### BACnet input objects

None

### BACnet output objects

Object name	Object type	Unit	COV send condition
<b>Operating mode Scheduler WebUI: State</b>	<b>Positive integer value</b>	<b>95 (No Units)</b>	<b>1.0</b>
The current operating mode, based on the scheduler, is output. Signal value:     0 = Off 1 = On			

# ABB i-bus<sup>®</sup> KNX Parameters

7.14.6

WebUI

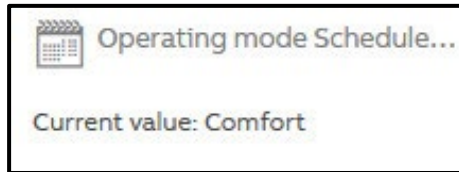

Open the detailed view of the ASM by clicking the ASM's tile.

## **Menu bar**

### **Week:**

Set the weekly switching times from Monday to Sunday used every week on the *Week* page.

### **Exceptions:**

Set the rules for exceptions for instance for holidays on the *Exceptions* page. These exceptions override the switching times specified on the *Week* page.

### **Calendar:**

The resulting switching times are displayed on the *Calendar* page. You can select each date and view the switching times set for this day consisting of the weekly switching times and the exceptions defined. It is not possible to change the switching times on this page.

# ABB i-bus<sup>®</sup> KNX Parameters

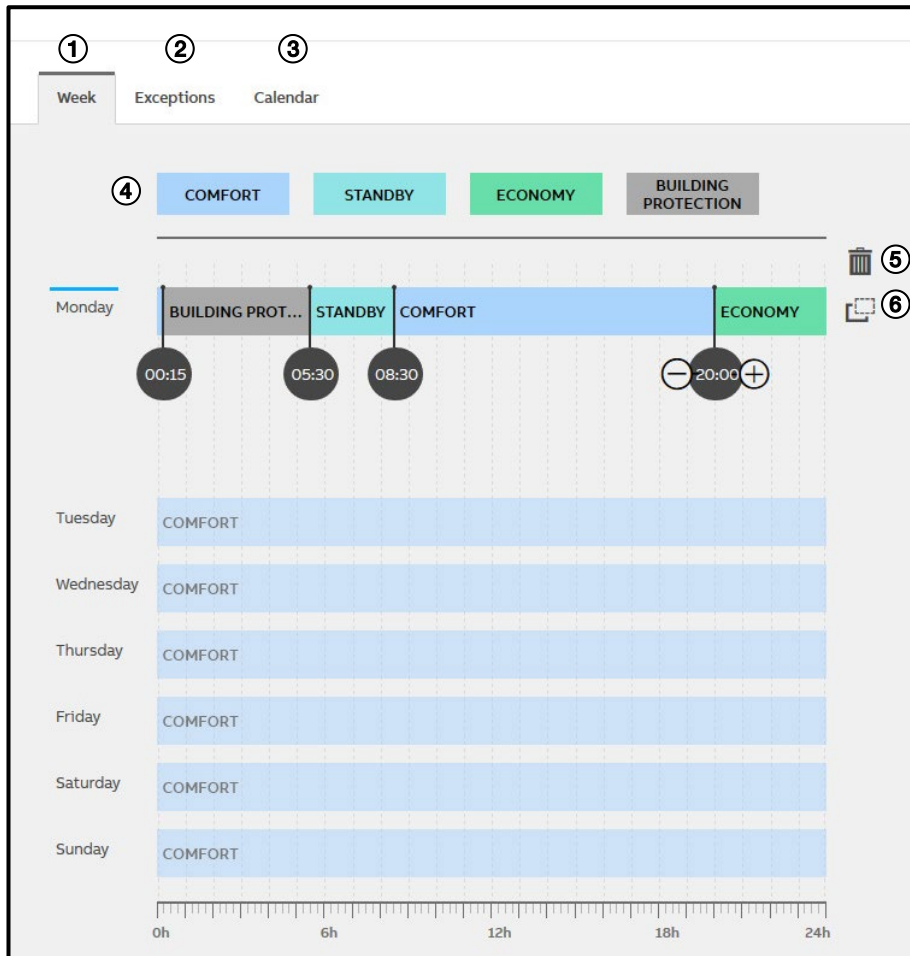

# ABB i-bus<sup>®</sup> KNX

## Parameters

### Week page ①

Program the weekly switching times from Monday to Sunday on the *Week* page.

Click the day of the week to be programmed to select it; further information on the switching times is then displayed.

Set the switching times by dragging the related switching command from the action bar ④ to the required time on the selected day (drag & drop).

The switching commands COMFORT, STANDBY, ECONOMY and BUILDING PROTECTION are available.

You can add as many switching times as necessary. The minimum spacing between two switching commands is 15 minutes. The end time for a switching command is the start time for the next command. A switching command applies to the end of the day as a maximum, the switching command on the next day then becomes active.

You can adjust the start time for a switching command by dragging the circle horizontally or by clicking the + / - buttons beside the circle.

An existing switching time can be converted to a different switching command. E.g. a COMFORT switching command can be changed into a STANDBY switching command by first clicking STANDBY on the action bar and then clicking the COMFORT switching time to be changed. It is not possible to change existing switching commands by dragging (drag & drop).

You can copy the switching times on one day to another day by dragging the *Copy* ⑥ icon for the original day to the destination day (drag & drop). All existing switching times on the destination day are overwritten by this process.

Click the *trash bin* ⑤ beside the selected day of the week to delete all switching times on that day.

After this action you can program a specific switching pattern for each day of the week. The switching patterns for a day of the week are applied to each corresponding day of the week, i.e. a switching pattern that has been set, e.g., for a Tuesday applies to all subsequent Tuesdays in the future.

# ABB i-bus<sup>®</sup> KNX Parameters

## Exceptions page ②

Set on this page the exceptions for the switching times defined on the day of the week page. An exception can cover one or more days. The exception replaces all switching times on a day!

Click the *Add exception* ⑦ button to add a new exception; you can assign a specific name for the exception in the *Name* ⑪ field. If a name is not specified, a name is generated automatically on saving.

Set the switching times as described for the Week page.



# ABB i-bus<sup>®</sup> KNX Parameters

In the section underneath, set the days to which this exception is to apply.

⑫ Date
⑬ Yearly
⑭ Monthly
⑮ Weekly

←
July 2018

W	Mon.	Tue.	Wed.	Thu.	Fri.	Sat.	Sun.
26	25	26	27	28	29	30	1
27	2	3	4	5	6	7	8
28	9	10	11	12	13	14	15
29	16	17	18	19	20	21	22
30	23	24	25	26	27	28	29
31	30	31	1	2	3	4	5

→
August 2018

W	Mon.	Tue.	Wed.	Thu.	Fri.	Sat.	Sun.
31	30	31	1	2	3	4	5
32	6	7	8	9	10	11	12
33	13	14	15	16	17	18	19
34	20	21	22	23	24	25	26
35	27	28	29	30	31	1	2
36	3	4	5	6	7	8	9

Cancel
Create exception

⑯
⑰

# ABB i-bus<sup>®</sup> KNX

## Parameters

### **Date tab:** ⑫

Here you can set an exception for a day or for a contiguous sequence of days that is applied once in the period parameterized.

To add an exception for a day, select the required month using the arrow buttons and click the required day using the left mouse button. The selection is marked in blue and is displayed in the two date fields as the start and end date for the exception.

To add an exception for a contiguous sequence of days, select the required month using the arrow buttons and click the required start day and then the required end day. The selection is marked in blue and is displayed in the two date fields as the start and end date for the exception. Alternatively, you can enter the start and end date directly in the date fields. Programming over several months is possible.

### **Yearly tab:** ⑬

Here you can set an exception for a day or for a contiguous sequence of days that is applied every year. Program the exception using the procedure described for the Date tab. Programming over several months is possible.

The exception is applied every year until it is deleted.

### **Monthly tab:** ⑭

Here you can set an exception for a day or for a contiguous sequence of days that is applied every month. Program the exception using the procedure described for the Date tab. Programming over several months is not possible.

The exception is applied every month until it is deleted.

# ABB i-bus<sup>®</sup> KNX Parameters

## **Weekly tab:** ⑮

Here you can set an exception for a day or for a contiguous sequence of days that is applied repeatedly within the date range set.

Program the exception using the procedure described for the Date tab. Programming over several months is possible.

Use the Repeat every xxx Week(s) field to set the frequency with which the exception programmed is to be applied (weekly, 2-weeks, etc.). The count always starts from the start date. The blue marking on the calendar is changed to suit the repetition selected.

By default the exception programmed here applies to all days of the week; if you clear the checkbox in the weekday bar, individual days can be excluded from the exception. The blue marking on the calendar is changed to suit.

Click the *Create exception* ⑰ button to save the exception; the programming is then active.

Click the *Cancel* ⑱ button to cancel the addition of the exception.

The exception switching times can overlap. In this situation the exception switching time that is positioned the highest on the list ⑲ applies. The exception switching times can be dragged in the list by clicking the switching time, holding the mouse button pressed and dragging (drag & drop).

You can delete an exception by clicking ⑳.

You can copy the settings for an exception to another exception by clicking the ㉑ icon and keeping the mouse button pressed and dragging to the required destination exception (drag & drop).

# ABB i-bus<sup>®</sup> KNX

## Parameters

### Calendar page ③

The resulting switching times for any day are displayed on the *Calendar* page. These represent the combination of the standard weekly scheduler and the exception switching times with the different priorities. The *Calendar* page therefore shows the switching commands that are sent on the KNX bus.

Use the arrow buttons to select the required month; click any day to display the switching pattern for the related day. The switching pattern for the complete week containing the selected day is also displayed in the overview rows underneath.

### General

Any change to the timer on the web user interface is saved and becomes active immediately.

Several users can access the scheduler on the web user interface and make changes at the same time. These changes are copied to the other users in real time. Only exception switching times cannot be edited at the same time. If several users select the same exception switching time, only the first user can edit this switching time. The other users receive a message that this exception switching time is locked by another user. As soon as the first user closes the exception switching time, it is released for editing again.

# ABB i-bus<sup>®</sup> KNX Parameters

## 7.15 ON/OFF Scheduler WebUI ASM

### 7.15.1 General

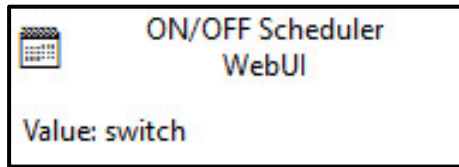

This application-specific automation module (ASM) is an on/off timer. The switching times are parametrized via the web user interface. Switching commands can be set to the minute for each weekday, and exceptions (e.g. for holidays) can be defined on a weekly, monthly and yearly basis.

The application controller outputs the switching command on the KNX bus, on the ASM output socket and on BACnet.

#### Note

It is essential the clock in the application controller is set to operate this module.

### 7.15.2 Settings

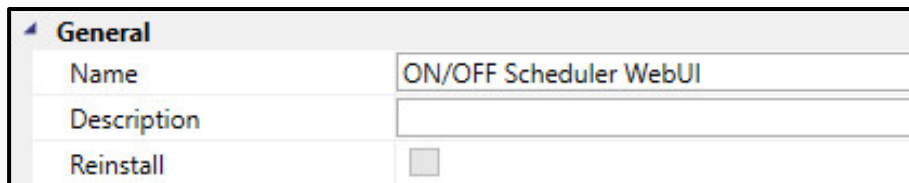

#### **General**

You will find descriptions of the global settings (Name, Description, Reinstall, BACnet, WebUI) in [chapter 7.3. Global ASM settings](#).

# ABB i-bus® KNX Parameters

## 7.15.3

### Sockets

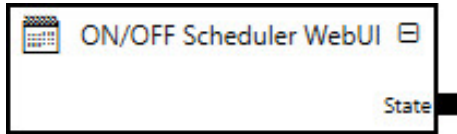

Overview of the ASM sockets for linking to other modules:

#### Input sockets

None

#### Output sockets

Object name	Data type
<b>State</b>	<b>DPT 1.001</b>
The current value, based on the scheduler, is output for the linking to other modules. Signal value:     0 = Off 1 = On	

## 7.15.4

### Group objects

Object function	Name (can be changed separately)	Data type	Flags
<b>Output: State</b>	<b>ON/OFF Scheduler WebUI</b>	<b>1 bit DPT 1.001</b>	<b>C, R, T</b>
The current value, based on the scheduler, is output. Telegram value:     0 = Off 1 = On			

# ABB i-bus<sup>®</sup> KNX Parameters

7.15.5

## BACnet objects

### BACnet input objects

None

### BACnet output objects

Object name	Object type	Unit	COV send condition
<b>ON/OFF Scheduler WebUI: State</b>	<b>Binary value</b>	-	-
The current value, based on the scheduler, is output. Signal value:     0 = Off 1 = On			

# ABB i-bus® KNX Parameters

7.15.6

## WebUI

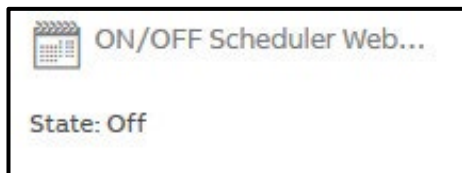

Open the detailed view of the ASM by clicking the ASM's tile.

### Menu bar

#### **Week:**

Set the weekly switching times from Monday to Sunday used every week on the *Week* page.

#### **Exceptions:**

Set the rules for exceptions for instance for holidays on the *Exceptions* page. These exceptions override the switching times specified on the *Week* page.

#### **Calendar:**

The resulting switching times are displayed on the *Calendar* page. You can select each date and view the switching times set for this day consisting of the weekly switching times and the exceptions defined. It is not possible to change the switching times on this page.



# ABB i-bus<sup>®</sup> KNX Parameters

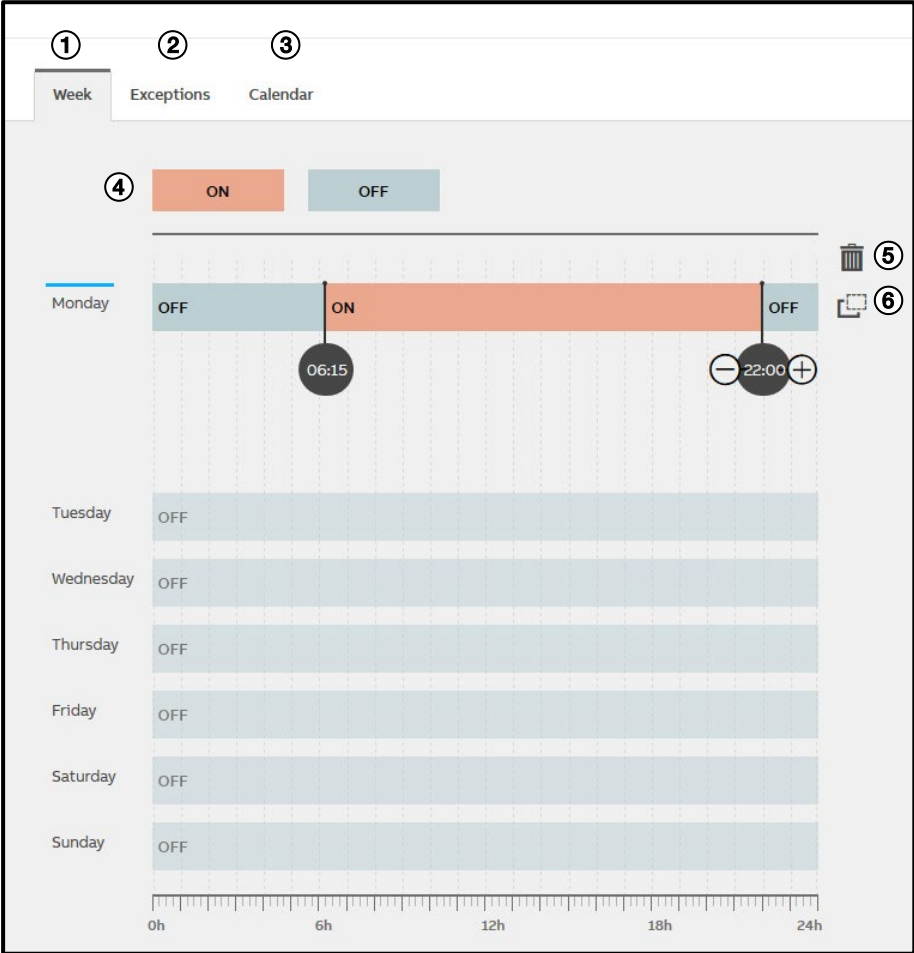

# ABB i-bus® KNX

## Parameters

### Week page ①

Program the weekly switching times from Monday to Sunday on the *Week* page.

Click the day of the week to be programmed to select it; further information on the switching times is then displayed.

Set the switching times by dragging the related switching command from the action bar ④ to the required time on the selected day (drag & drop).

The switching commands ON and OFF are available.

You can add as many switching times as necessary. The minimum spacing between two switching commands is 15 minutes. The end time for a switching command is the start time for the next command. A switching command applies to the end of the day as a maximum, the switching command on the next day then becomes active.

You can adjust the start time for a switching command by dragging the circle horizontally or by clicking the + / - buttons beside the circle.

An existing switching time can be converted to a different switching command. E.g. an ON switching command can be changed into an OFF switching command by first clicking OFF on the action bar and then clicking the ON switching time to be changed. It is not possible to change existing switching commands by dragging (drag & drop).

You can copy the switching times on one day to another day by dragging the *Copy* ⑥ icon for the original day to the destination day (drag & drop). All existing switching times on the destination day are overwritten by this process.

Click the *trash bin* ⑤ beside the selected day of the week to delete all switching times on that day.

After this action you can program a specific switching pattern for each day of the week. The switching patterns for a day of the week are applied to each corresponding day of the week, i.e. a switching pattern that has been set, e.g., for a Tuesday applies to all subsequent Tuesdays in the future.

# ABB i-bus<sup>®</sup> KNX Parameters

## Exceptions page ②

Set on this page the exceptions for the switching times defined on the day of the week page. An exception can cover one or more days. The exception replaces all switching times on a day!

Click the *Add exception* ⑦ button to add a new exception; you can assign a specific name for the exception in the *Name* ⑪ field. If a name is not specified, a name is generated automatically on saving.  
Set the switching times as described for the Week page.

# ABB i-bus<sup>®</sup> KNX Parameters

In the section underneath, set the days to which this exception is to apply.

⑫ Date⑬ Yearly⑭ Monthly⑮ Weekly

< July 2018

W	Mon.	Tue.	Wed.	Thu.	Fri.	Sat.	Sun.
26	25	26	27	28	29	30	1
27	2	3	4	5	6	7	8
28	9	10	11	12	13	14	15
29	16	17	18	19	20	21	22
30	23	24	25	26	27	28	29
31	30	31	1	2	3	4	5

August 2018 >

W	Mon.	Tue.	Wed.	Thu.	Fri.	Sat.	Sun.
31	30	31	1	2	3	4	5
32	6	7	8	9	10	11	12
33	13	14	15	16	17	18	19
34	20	21	22	23	24	25	26
35	27	28	29	30	31	1	2
36	3	4	5	6	7	8	9

CancelCreate exception

⑯⑰

# ABB i-bus<sup>®</sup> KNX Parameters

## **Date tab:** ⑫

Here you can set an exception for a day or for a contiguous sequence of days that is applied once in the period parameterized.

To add an exception for a day, select the required month using the arrow buttons and click the required day using the left mouse button. The selection is marked in blue and is displayed in the two date fields as the start and end date for the exception.

To add an exception for a contiguous sequence of days, select the required month using the arrow buttons and click the required start day and then the required end day. The selection is marked in blue and is displayed in the two date fields as the start and end date for the exception. Alternatively, you can enter the start and end date directly in the date fields. Programming over several months is possible.

## **Yearly tab:** ⑬

Here you can set an exception for a day or for a contiguous sequence of days that is applied every year. Program the exception using the procedure described for the Date tab. Programming over several months is possible.

The exception is applied every year until it is deleted.

## **Monthly tab:** ⑭

Here you can set an exception for a day or for a contiguous sequence of days that is applied every month. Program the exception using the procedure described for the Date tab. Programming over several months is not possible.

The exception is applied every month until it is deleted.

# ABB i-bus® KNX

## Parameters

### **Weekly tab:** ⑮

Here you can set an exception for a day or for a contiguous sequence of days that is applied repeatedly within the date range set.

Program the exception using the procedure described for the Date tab. Programming over several months is possible.

Use the Repeat every xxx Week(s) field to set the frequency with which the exception programmed is to be applied (weekly, 2-weeks, etc.). The count always starts from the start date. The blue marking on the calendar is changed to suit the repetition selected.

By default the exception programmed here applies to all days of the week; if you clear the checkbox in the weekday bar, individual days can be excluded from the exception. The blue marking on the calendar is changed to suit.

Click the *Create exception* ⑰ button to save the exception; the programming is then active.

Click the *Cancel* ⑱ button to cancel the addition of the exception.

The exception switching times can overlap. In this situation the exception switching time that is positioned the highest on the list ⑲ applies. The exception switching times can be dragged in the list by clicking the switching time, holding the mouse button pressed and dragging (drag & drop).

You can delete an exception by clicking ⑳.

You can copy the settings for an exception to another exception by clicking the ㉑ icon and keeping the mouse button pressed and dragging to the required destination exception (drag & drop).

# ABB i-bus<sup>®</sup> KNX

## Parameters

### **Calendar page** ③

The resulting switching times for any day are displayed on the *Calendar* page. These represent the combination of the standard weekly scheduler and the exception switching times with the different priorities. The *Calendar* page therefore shows the switching commands that are sent on the KNX bus.

Use the arrow buttons to select the required month; click any day to display the switching pattern for the related day. The switching pattern for the complete week containing the selected day is also displayed in the overview rows underneath.

### **General**

Any change to the timer on the web user interface is saved and becomes active immediately.

Several users can access the scheduler on the web user interface and make changes at the same time. These changes are copied to the other users in real time. Only exception switching times cannot be edited at the same time. If several users select the same exception switching time, only the first user can edit this switching time. The other users receive a message that this exception switching time is locked by another user. As soon as the first user closes the exception switching time, it is released for editing again.

# ABB i-bus<sup>®</sup> KNX Parameters

## 7.16 Temperature Scheduler WebUI ASM

### 7.16.1 General

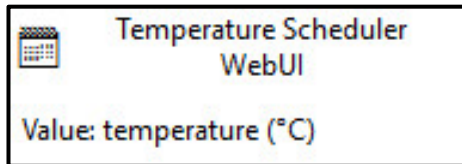

This application-specific automation module (ASM) is a timer for temperatures. The switching times are parametrized via the web user interface. Switching commands can be set to the minute for each weekday, and exceptions (e.g. for holidays) can be defined on a weekly, monthly and yearly basis.

The application controller outputs the switching command on the KNX bus, on the ASM output socket and on BACnet.

#### Note

It is essential the clock in the application controller is set to operate this module.

### 7.16.2 Settings

General	
Name	Temperature Scheduler WebUI
Description	
Reinstall	<input type="checkbox"/>

#### **General**

You will find descriptions of the global settings (Name, Description, Reinstall, BACnet, WebUI) in [chapter 7.3. Global ASM settings](#).



# ABB i-bus<sup>®</sup> KNX Parameters

7.16.3

## Sockets

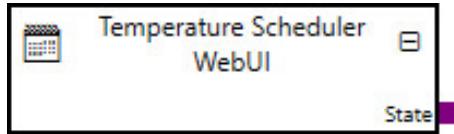

Overview of the ASM sockets for linking to other modules:

### Input sockets

None

### Output sockets

Object name	Data type
<b>State</b>	<b>DPT 9.001</b>
The current value, based on the scheduler, is output for the linking to other modules. Signal value:       -273...670760 °C	

7.16.4

## Group objects

Object function	Name (can be changed separately)	Data type	Flags
<b>Output: State</b>	<b>Temperature Scheduler WebUI</b>	<b>2 bytes DPT 9.001</b>	<b>C, R, T</b>
The current value, based on the scheduler, is output. Telegram value:       -273...670760 °C			

# ABB i-bus<sup>®</sup> KNX Parameters

## 7.16.5 BACnet objects

### BACnet input objects

None

### BACnet output objects

Object name	Object type	Unit	COV send condition
<b>Temperature Scheduler WebUI: State</b>	<b>Analog value</b>	<b>°C (62)</b>	<b>1.0</b>
The current temperature, based on the scheduler, is output. Signal value: -273...670760 °C			

# ABB i-bus<sup>®</sup> KNX Parameters

7.16.6

WebUI

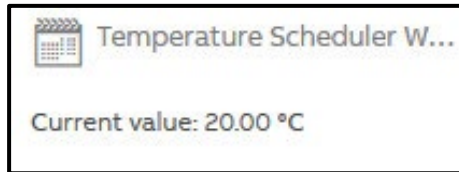

Open the detailed view of the ASM by clicking the ASM's tile.

### **Menu bar**

#### **Week:**

Set the weekly switching times from Monday to Sunday used every week on the *Week* page.

#### **Exceptions:**

Set the rules for exceptions for instance for holidays on the *Exceptions* page. These exceptions override the switching times specified on the *Week* page.

#### **Calendar:**

The resulting switching times are displayed on the *Calendar* page. You can select each date and view the switching times set for this day consisting of the weekly switching times and the exceptions defined. It is not possible to change the switching times on this page.

# ABB i-bus<sup>®</sup> KNX Parameters

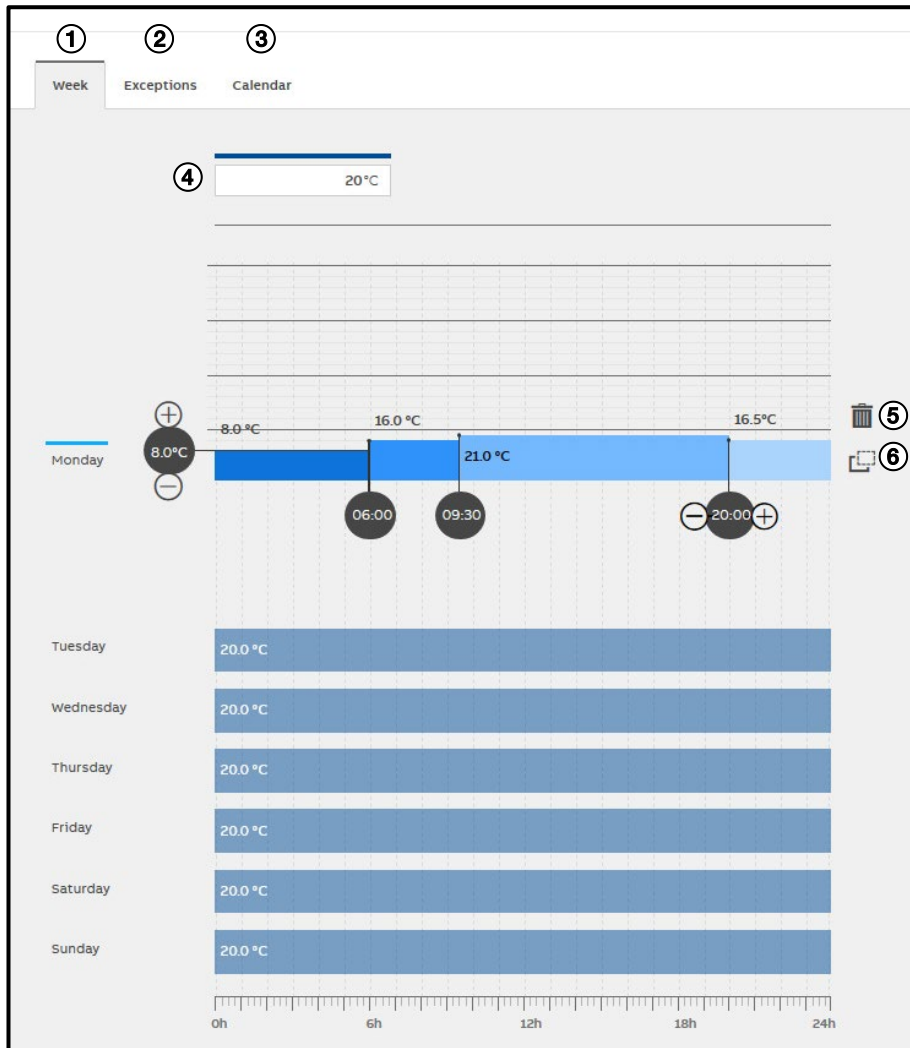

# ABB i-bus<sup>®</sup> KNX

## Parameters

### Week page ①

Program the weekly switching times from Monday to Sunday on the *Week* page.

Click the day of the week to be programmed to select it; further information on the switching times is then displayed.

Set the switching times by dragging the related switching command from the action bar ④ to the required time on the selected day (drag & drop).

You can enter any temperature in the range from -20.0 °C to 150.0 °C.

You can add as many switching times as necessary. The minimum spacing between two switching commands is 15 minutes. The end time for a switching command is the start time for the next command. A switching command applies to the end of the day as a maximum, the switching command on the next day then becomes active.

You can adjust the start time for a switching command by dragging the circle horizontally or by clicking the + / - buttons beside the circle.

You adjust the temperature for a switching command by dragging the circle on the left or by clicking the + / - buttons beside the circle.

You can copy the switching times on one day to another day by dragging the *Copy* ⑥ icon for the original day to the destination day (drag & drop). All existing switching times on the destination day are overwritten by this process.

Click the *trash bin* ⑤ beside the selected day of the week to delete all switching times on that day.

After this action you can program a specific switching pattern for each day of the week. The switching patterns for a day of the week are applied to each corresponding day of the week, i.e. a switching pattern that has been set, e.g., for a Tuesday applies to all subsequent Tuesdays in the future.

# ABB i-bus<sup>®</sup> KNX Parameters

## Exceptions page ②

Set on this page the exceptions for the switching times defined on the day of the week page. An exception can cover one or more days. The exception replaces all switching times on a day!

Click the *Add exception* ⑦ button to add a new exception; you can assign a specific name for the exception in the *Name* ⑪ field. If a name is not specified, a name is generated automatically on saving.

Set the switching times as described for the Week page.

# ABB i-bus<sup>®</sup> KNX Parameters

In the section underneath, set the days to which this exception is to apply.

⑫ Date
⑬ Yearly
⑭ Monthly
⑮ Weekly

←
July 2018

W	Mon.	Tue.	Wed.	Thu.	Fri.	Sat.	Sun.
26	25	26	27	28	29	30	1
27	2	3	4	5	6	7	8
28	9	10	11	12	13	14	15
29	16	17	18	19	20	21	22
30	23	24	25	26	27	28	29
31	30	31	1	2	3	4	5

→
August 2018

W	Mon.	Tue.	Wed.	Thu.	Fri.	Sat.	Sun.
31	30	31	1	2	3	4	5
32	6	7	8	9	10	11	12
33	13	14	15	16	17	18	19
34	20	21	22	23	24	25	26
35	27	28	29	30	31	1	2
36	3	4	5	6	7	8	9

⑯
⑰

# ABB i-bus<sup>®</sup> KNX

## Parameters

### **Date tab:** ⑫

Here you can set an exception for a day or for a contiguous sequence of days that is applied once in the period parameterized.

To add an exception for a day, select the required month using the arrow buttons and click the required day using the left mouse button. The selection is marked in blue and is displayed in the two date fields as the start and end date for the exception.

To add an exception for a contiguous sequence of days, select the required month using the arrow buttons and click the required start day and then the required end day. The selection is marked in blue and is displayed in the two date fields as the start and end date for the exception. Alternatively, you can enter the start and end date directly in the date fields. Programming over several months is possible.

### **Yearly tab:** ⑬

Here you can set an exception for a day or for a contiguous sequence of days that is applied every year. Program the exception using the procedure described for the Date tab. Programming over several months is possible.

The exception is applied every year until it is deleted.

### **Monthly tab:** ⑭

Here you can set an exception for a day or for a contiguous sequence of days that is applied every month. Program the exception using the procedure described for the Date tab. Programming over several months is not possible.

The exception is applied every month until it is deleted.



# ABB i-bus<sup>®</sup> KNX Parameters

## **Weekly tab:** ⑮

Here you can set an exception for a day or for a contiguous sequence of days that is applied repeatedly within the date range set.

Program the exception using the procedure described for the Date tab. Programming over several months is possible.

Use the Repeat every xxx Week(s) field to set the frequency with which the exception programmed is to be applied (weekly, 2-weeks, etc.). The count always starts from the start date. The blue marking on the calendar is changed to suit the repetition selected.

By default the exception programmed here applies to all days of the week; if you clear the checkbox in the weekday bar, individual days can be excluded from the exception. The blue marking on the calendar is changed to suit.

Click the *Create exception* ⑰ button to save the exception; the programming is then active.

Click the *Cancel* ⑱ button to cancel the addition of the exception.

The exception switching times can overlap. In this situation the exception switching time that is positioned the highest on the list ⑲ applies. The exception switching times can be dragged in the list by clicking the switching time, holding the mouse button pressed and dragging (drag & drop).

You can delete an exception by clicking ⑳.

You can copy the settings for an exception to another exception by clicking the ㉑ icon and keeping the mouse button pressed and dragging to the required destination exception (drag & drop).

# ABB i-bus<sup>®</sup> KNX

## Parameters

### Calendar page ③

The resulting switching times for any day are displayed on the *Calendar* page. These represent the combination of the standard weekly scheduler and the exception switching times with the different priorities. The *Calendar* page therefore shows the switching commands that are sent on the KNX bus.

Use the arrow buttons to select the required month; click any day to display the switching pattern for the related day. The switching pattern for the complete week containing the selected day is also displayed in the overview rows underneath.

### General

Any change to the timer on the web user interface is saved and becomes active immediately.

Several users can access the scheduler on the web user interface and make changes at the same time. These changes are copied to the other users in real time. Only exception switching times cannot be edited at the same time. If several users select the same exception switching time, only the first user can edit this switching time. The other users receive a message that this exception switching time is locked by another user. As soon as the first user closes the exception switching time, it is released for editing again.

# ABB i-bus<sup>®</sup> KNX Parameters

## 7.17 Operating mode Scheduler BACnet ASM

### 7.17.1 General

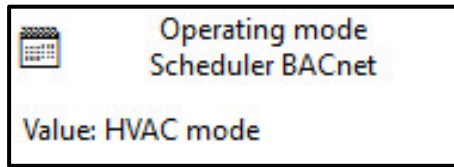

This application-specific automation module (ASM) is a timer for the HVAC operating mode (Comfort, Standby, Economy, Building Protection). The switching times are parametrized by other BACnet devices via the BACnet interface of the application controller. The switching times can be viewed via the web user interface.

The application controller outputs the switching command on the KNX bus and on the ASM output socket.

The application controller ensures that the switching commands are executed, even if there is a malfunction in the BACnet system.

#### Note

It is essential the clock in the application controller is set to operate this module.

### 7.17.2 Settings

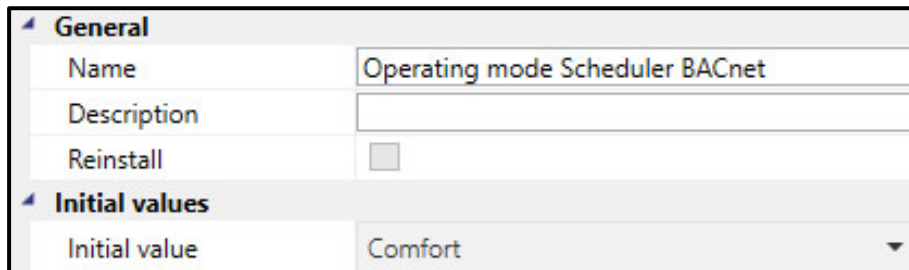

#### General

You will find descriptions of the global settings (Name, Description, Reinstall, BACnet, WebUI) in [chapter 7.3, Global ASM settings](#).

# ABB i-bus<sup>®</sup> KNX Parameters

## **Initial values**

### **Initial value**

Options:            Comfort  
                     Standby  
                     Economy  
                     Building Protection

This parameter specifies which value is output in the group object and on the ASM output socket if no value switching times have been parameterized via BACnet. For example, after downloading the module to the application controller.

## **Properties panel BACnet, Calendar**

### **Activated**

Options:            No (checkbox cleared)  
                     Yes (checkbox selected)

In the *BACnet* parameter window for this module you can activate a BACnet calendar object on the BACnet interface. This BACnet calendar object can be used to define an additional exception calendar and to link this to any BACnet scheduler in the BACnet system.

You will find further descriptions on the settings in the BACnet parameter window in [chapter 7.3.2, BACnet](#).

# ABB i-bus<sup>®</sup> KNX Parameters

## 7.17.3

### Sockets

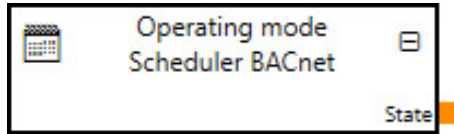

Overview of the ASM sockets for linking to other modules:

#### Input sockets

None

#### Output sockets

Object name	Data type
<b>State</b>	<b>DPT 20.102</b>
The current value, based on the scheduler, is output for the linking to other modules.	
Signal value:      1 = Comfort 2 = Standby 3 = Economy 4 = Building Protection	

## 7.17.4

### Group objects

Object function	Name (can be changed separately)	Data type	Flags
<b>Output: State</b>	<b>Operating mode Scheduler BACnet</b>	<b>1 byte DPT 20.102</b>	<b>C, R, T</b>
The current value, based on the scheduler, is output.			
Telegram value:      1 = Comfort 2 = Standby 3 = Economy 4 = Building Protection			

# ABB i-bus<sup>®</sup> KNX Parameters

7.17.5

## BACnet objects

Type	BACnet name	Object type	Unit	COV send condition
Input	ON/OFF Scheduler BACnet: State	Schedule	-	-
Input	ON/OFF Scheduler BACnet: Calendar	Calendar	-	-

### BACnet input objects

Object name	Object type	Unit	COV send condition
<b>Operating mode Scheduler BACnet: State</b>	<b>Schedule</b>	<b>Multistate</b>	-
Use this BACnet object of type Schedule to parametrize the switching times with the related operating types via BACnet. Signal value: <ul style="list-style-type: none"> <li>1 = Comfort</li> <li>2 = Standby</li> <li>3 = Economy</li> <li>4 = Building Protection</li> </ul>			
<b>Operating mode Scheduler BACnet: Calendar</b>	<b>Calendar</b>	-	-
The module has this BACnet input object if the <i>Yes</i> option is selected for the <i>Activated</i> parameter in <i>Calendar</i> section of the <a href="#">BACnet parameter window</a> .  This BACnet calendar object can be used to define an additional exception calendar and to link this to any BACnet scheduler in the BACnet system.			

### BACnet output objects

None

# ABB i-bus<sup>®</sup> KNX Parameters

7.17.6

WebUI

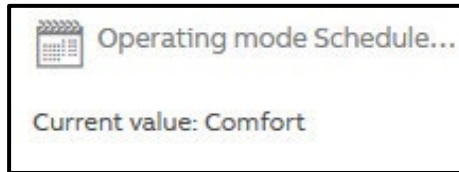

Open the detailed view of the ASM by clicking the ASM's tile.

You can display the switching times parameterized via BACnet for any day. Use the arrow buttons to select the required month; click any day to display the switching pattern for the related day. The switching pattern for the complete week containing the selected day is also displayed in the overview rows underneath.

The view is intended to provide an overview and to be used for checking. It is not possible to change the switching times via the web user interface.

The resulting switching times are displayed on the web user interface. These represent the combination of the BACnet weekly scheduler and the BACnet exception switching times with the different priorities. The web user interface therefore shows the switching commands that are sent on the KNX bus.

# ABB i-bus® KNX Parameters

## 7.18 ON/OFF Scheduler BACnet ASM

### 7.18.1 General

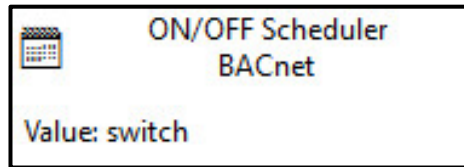

This application-specific automation module (ASM) is an on/off timer. The switching times are parametrized by other BACnet devices via the BACnet interface of the application controller. The switching times can be viewed via the web user interface.

The application controller outputs the switching command on the KNX bus and on the ASM output socket.

The application controller ensures that the switching commands are executed, even if there is a malfunction in the BACnet system.

#### Note

It is essential the clock in the application controller is set to operate this module.

### 7.18.2 Settings

General	
Name	ON/OFF Scheduler BACnet
Description	
Reinstall	<input type="checkbox"/>
Initial values	
Initial value	Off

#### General

You will find descriptions of the global settings (Name, Description, Reinstall, BACnet, WebUI) in [chapter 7.3. Global ASM settings](#).



# ABB i-bus<sup>®</sup> KNX Parameters

## **Initial values**

### **Initial value**

Options:            Off  
                         On

This parameter specifies which value is output in the group object and on the ASM output socket if no value switching times have been parameterized via BACnet. For example, after downloading the module to the application controller.

## **Properties panel BACnet, Calendar**

### **Activated**

Options:            No (checkbox cleared)  
                         Yes (checkbox selected)

In the *BACnet* parameter window for this module you can activate a BACnet calendar object on the BACnet interface. This BACnet calendar object can be used to define an additional exception calendar and to link this to any BACnet scheduler in the BACnet system.

You will find further descriptions on the settings in the BACnet parameter window in [chapter 7.3.2. BACnet](#).

# ABB i-bus® KNX Parameters

## 7.18.3

### Sockets

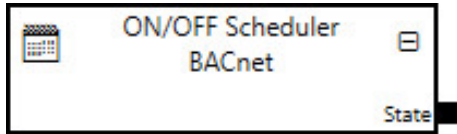

Overview of the ASM sockets for linking to other modules:

#### Input sockets

None

#### Output sockets

Object name	Data type
<b>State</b>	<b>DPT 1.001</b>
The current value, based on the scheduler, is output for the linking to other modules. Signal value:     0 = Off 1 = On	

## 7.18.4

### Group objects

Object function	Name (can be changed separately)	Data type	Flags
<b>Output: State</b>	<b>ON/OFF Scheduler BACnet</b>	<b>1 bit DPT 1.001</b>	<b>C, R, T</b>
The current value, based on the scheduler, is output. Telegram value:     0 = Off 1 = On			

# ABB i-bus<sup>®</sup> KNX Parameters

## 7.18.5

### BACnet objects

Type	BACnet name	Object type	Unit	COV send condition
Input	ON/OFF Scheduler BACnet: State	Schedule	-	-
Input	ON/OFF Scheduler BACnet: Calendar	Calendar	-	-

### BACnet input objects

Object name	Object type	Unit	COV send condition
<b>ON/OFF Scheduler BACnet: State</b>	<b>Schedule</b>	-	-
Use this BACnet object of type Schedule to parameterize the switching times via BACnet. Signal value:     0 = Off 1 = On			
<b>ON/OFF Scheduler BACnet: Calendar</b>	<b>Calendar</b>	-	-
The module has this BACnet input object if the <i>Yes</i> option is selected for the <i>Activated</i> parameter in <i>Calendar</i> section of the <a href="#">BACnet parameter window</a> .  This BACnet calendar object can be used to define an additional exception calendar and to link this to any BACnet scheduler in the BACnet system.			

### BACnet output objects

None

# ABB i-bus® KNX Parameters

7.18.6

## WebUI

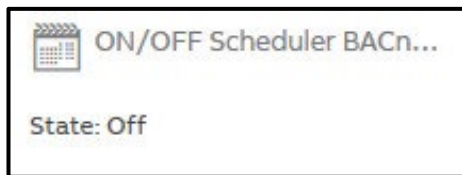

Open the detailed view of the ASM by clicking the ASM's tile.

You can display the switching times parameterized via BACnet for any day. Use the arrow buttons to select the required month; click any day to display the switching pattern for the related day. The switching pattern for the complete week containing the selected day is also displayed in the overview rows underneath.

The view is intended to provide an overview and to be used for checking. It is not possible to change the switching times via the web user interface.

The resulting switching times are displayed on the web user interface. These represent the combination of the BACnet weekly scheduler and the BACnet exception switching times with the different priorities. The web user interface therefore shows the switching commands that are sent on the KNX bus.

# ABB i-bus<sup>®</sup> KNX Parameters

## 7.19 Temperature Scheduler BACnet ASM

### 7.19.1 General

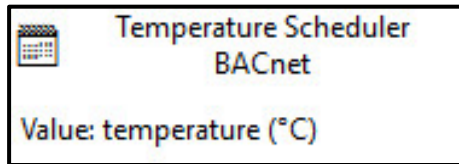

This application-specific automation module (ASM) is a timer for temperatures. The switching times are parametrized by other BACnet devices via the BACnet interface of the application controller. The switching times can be viewed via the web user interface.

The application controller outputs the switching command on the KNX bus and on the ASM output socket.

The application controller ensures that the switching commands are executed, even if there is a malfunction in the BACnet system.

#### Note

It is essential the clock in the application controller is set to operate this module.

### 7.19.2 Settings

<b>General</b>	
Name	Temperature Scheduler BACnet
Description	
Reinstall	<input type="checkbox"/>
<b>Initial values</b>	
Initial value	20 °C

#### General

You will find descriptions of the global settings (Name, Description, Reinstall, BACnet, WebUI) in [chapter 7.3, Global ASM settings](#).

# ABB i-bus<sup>®</sup> KNX

## Parameters

### **Initial values**

#### **Initial value**

Options:            -273...20...670760 °C

This parameter specifies which value is output in the group object and on the ASM output socket if no value switching times have been parameterized via BACnet. For example, after downloading the module to the application controller.

### **Properties panel BACnet, Calendar**

#### **Activated**

Options:            No (checkbox cleared)  
                      Yes (checkbox selected)

In the *BACnet* parameter window for this module you can activate a BACnet calendar object on the BACnet interface. This BACnet calendar object can be used to define an additional exception calendar and to link this to any BACnet scheduler in the BACnet system.

You will find further descriptions on the settings in the BACnet parameter window in [chapter 7.3.2. BACnet](#).

# ABB i-bus<sup>®</sup> KNX Parameters

## 7.19.3

### Sockets

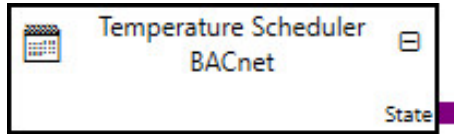

Overview of the ASM sockets for linking to other modules:

#### Input sockets

None

#### Output sockets

Object name	Data type
<b>State</b>	<b>DPT 9.001</b>
The current value, based on the scheduler, is output for the linking to other modules. Signal value:       -273...670760 °C	

## 7.19.4

### Group objects

Object function	Name (can be changed separately)	Data type	Flags
<b>Output: State</b>	<b>Temperature Scheduler BACnet</b>	<b>2 bytes DPT 9.001</b>	<b>C, R, T</b>
The current value, based on the scheduler, is output. Telegram value:       -273...670760 °C			

# ABB i-bus<sup>®</sup> KNX Parameters

## 7.19.5

### BACnet objects

Type	BACnet name	Object type	Unit	COV send condition
Input	Temperature Scheduler BACnet: State	Schedule	Multistate	-
Input	Temperature Scheduler BACnet: Calendar	Calendar	-	-

### BACnet input objects

Object name	Object type	Unit	COV send condition
<b>Temperature Scheduler BACnet: State</b>	<b>Schedule</b>	<b>Multistate</b>	-
Use this BACnet object of type Schedule to parameterize the switching times via BACnet. Signal value: -273...670760 °C			
<b>Temperature Scheduler BACnet: Calendar</b>	<b>Calendar</b>	-	-
The module has this BACnet input object if the <i>Yes</i> option is selected for the <i>Activated</i> parameter in <i>Calendar</i> section of the <a href="#">BACnet parameter window</a> .			
This BACnet calendar object can be used to define an additional exception calendar and to link this to any BACnet scheduler in the BACnet system.			

### BACnet output objects

None



# ABB i-bus<sup>®</sup> KNX Parameters

7.19.6

WebUI

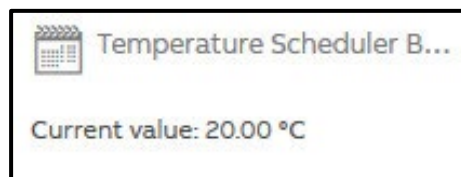

Open the detailed view of the ASM by clicking the ASM's tile.

You can display the switching times parameterized via BACnet for any day. Use the arrow buttons to select the required month; click any day to display the switching pattern for the related day. The switching pattern for the complete week containing the selected day is also displayed in the overview rows underneath.

The view is intended to provide an overview and to be used for checking. It is not possible to change the switching times via the web user interface.

The resulting switching times are displayed on the web user interface. These represent the combination of the BACnet weekly scheduler and the BACnet exception switching times with the different priorities. The web user interface therefore shows the switching commands that are sent on the KNX bus.

## 7.20 Trend ASM

### 7.20.1 General



Using this application-specific automation module (ASM), the application controller can record up to five independent values over a configurable period. The recordings are saved in the devices. They can be displayed on the web user interface and exported from there.

The values to be recorded must be sent via output sockets on other ASMs linked to the input sockets on this module. The values can therefore be telegram or signal values that are transmitted by KNX or BACnet to other ASMs and are then forwarded by these for recording. The Trend ASM itself does not have any group objects or BACnet objects.

The data point type is freely selectable for each input value. The recording duration and the recording frequency are set to suit the required application.

The Trend ASM has a ring memory that automatically deletes the oldest entries. If a recording duration of 1 year is selected, for example, recordings that are older than a year are automatically and irrevocably deleted.

The value valid at the selected measuring times is always saved. Different values between two measuring times are not saved.

The recordings are retained after a power failure and after a device restart.

#### Note

It is essential the clock in the application controller is set to operate this module.

# ABB i-bus<sup>®</sup> KNX Parameters

If the application controller's time is not valid, values will be stored only internally; an error message will be displayed on the web user interface. Only when a valid time is available will these recorded values be updated to the valid time and displayed. See [chapter 7.2.2.5, Clock parameter page](#) for further information on the device clock.

If the application controller receives summer/winter time changeover information via NTP, KNX or BACnet then

- On a clock change to summer time, the time 2 am is not displayed.
- On a clock change to winter time, the time 2 am is recorded and displayed twice.

On a change independent of summer/winter time to the time via NTP, KNX or BACnet

- If the time is moved forward there will be period without trends.
- If the time is moved back the existing recordings will be overwritten.

## 7.20.2

### Settings

<b>General</b>	
Name	Trend
Description	
Reinstall	<input type="checkbox"/>
<b>Interfaces</b>	
Range	Every 5 seconds of the last 24 hours ▼
Number of trends	1 ▼
<b>Trend1</b>	
Name	Trend1
Main data point type	9.xxx [2-byte float value] ▼
Data point type	9.001 [temperature (°C)] ▼

#### General

You will find descriptions of the global settings (Name, Description, Reinstall, BACnet, WebUI) in [chapter 7.3, Global ASM settings](#).

# ABB i-bus<sup>®</sup> KNX

## Parameters

### Interfaces

#### Range

Options:            Every 5 seconds of the last 24 hours  
Every 1 minute of the last 1 week  
Every 15 minutes of the last 1 month  
Every 1 hour of the last 1 year  
Every 1 hour of the last 3 years

This parameter selects a predefined selection for the duration of the recording and the frequency of the recording. This setting applies to all values recorded by this module.

#### Number of trends

Options:            1  
                         2  
                         3  
                         4  
                         5

This parameter specifies how many independent values are to be recorded by the module. An ASM input socket is activated for each value and the following parameters displayed.

#### **Note**

The settings for *Trend 1...5* are explained in the following based on *Trend 1*. The settings are identical for all trends.

### Trend1

#### Name

Name of the trend line that is displayed on the web user interface.

As long as the name has not been changed manually, it is assigned automatically on linking to an ASM output socket. The name generated automatically consists of the following: *Name of the module linked: Name of the output socket linked.*

# ABB i-bus<sup>®</sup> KNX

## Parameters

### Main data point type

#### Data point type

These two parameters select the data point type for the value recorded. The data point type for the ASM input socket is set based on this settings and the unit displayed on the web user interface.

The following data point types can be selected:

- 1.xxx [1-bit]
  - 1.\*
  - 1.001 [switch]
  - 1.002 [boolean]
  - 1.003 [enable]
  - 1.004 [rise]
  - 1.005 [alarm]
  - 1.006 [binary value]
  - 1.007 [step]
  - 1.008 [up/down]
  - 1.009 [open/close]
  - 1.010 [start/stop]
  - 1.011 [status]
  - 1.012 [inversion]
  - 1.013 [dimming send type]
  - 1.014 [input type]
- 5.xxx [8-bit unsigned]
  - 5.\*
  - 5.001 [percentage (0..100%)]
  - 5.003 [angle (degrees)]
  - 5.004 [percentage (0..255)]
  - 5.005 [ratio (0..255)]
  - 5.010 [counter pulses (0..255)]
- 6.xxx [8-bit signed]
  - 6.\*
  - 6.001 [percent (-128..127%)]
  - 6.002 [counter pulses (-128..127)]

# ABB i-bus<sup>®</sup> KNX

## Parameters

- 7.xxx [2-byte unsigned]
  - 7.\*
  - 7.001 [pulse]
  - 7.002 [time (ms)]
  - 7.003 [time (s)]
  - 7.007 [time (h)]
  - 7.011 [length (mm)]
  - 7.013 [brightness (lux)]
- 8.xxx [2-byte signed]
  - 8.\*
  - 8.001 [pulse difference]
  - 8.002 [time difference (ms)]
  - 8.005 [time difference (s)]
  - 8.007 [time difference (h)]
  - 8.010 [percent difference (%)]
  - 8.011 [angle of rotation (°)]
- 9.xxx [2-byte floating point value]
  - 9.\*
  - 9.001 [temperature (°C)]
  - 9.002 [temperature difference (K)]
  - 9.003 [kelvin/hour (K/h)]
  - 9.004 [lux (Lux)]
  - 9.005 [speed (m/s)]
  - 9.006 [pressure (Pal)]
  - 9.007 [humidity (%)]
  - 9.008 [parts/million (ppm)]
  - 9.010 [time (s)]
  - 9.011 [time (ms)]
  - 9.020 [voltage (mV)]
  - 9.021 [current (mA)]
  - 9.022 [power density (W/m<sup>2</sup>)]
  - 9.023 [kelvin/percent (K/%)]
  - 9.024 [power (kW)]
  - 9.025 [volume flow (l/h)]
  - 9.026 [rain amount (l/h)]
  - 9.027 [temperature (°F)]
  - 9.028 [wind speed (km/h)]

# ABB i-bus<sup>®</sup> KNX

## Parameters

- 12.xxx [4-byte unsigned]
  - 12.\*
  - 12.001 [counter pulses (unsigned)]
- 13.xxx [4-byte signed]
  - 13.\*
  - 13.001 [counter pulses (signed)]
  - 13.002 [flow rate (m<sup>3</sup>/h)]
  - 13.010 [active energy (Wh)]
  - 13.011 [apparent energy (VAh)]
  - 13.012 [reactive energy (VARh)]
  - 13.013 [active energy (kWh)]
  - 13.014 [apparent energy (kVAh)]
  - 13.015 [reactive energy (kVARh)]
- 14.xxx [4-byte floating point value]
  - 14.\*
  - 14.000 [acceleration (m/s<sup>2</sup>)]
  - 14.001 [angular acceleration (rad/s<sup>2</sup>)]
  - 14.002 [molar energy (J/mol)]
  - 14.003 [radioactivity (1/s)]
  - 14.004 [amount of substance (mol)]
  - 14.005 [amplitude]
  - 14.006 [angle (radian)]
  - 14.007 [angle (degree)]
  - 14.008 [angular momentum (Js)]
  - 14.009 [angular frequency (rad/s)]
  - 14.010 [area (m<sup>2</sup>)]
  - 14.011 [capacitance (F)]
  - 14.012 [flux density (C/m<sup>2</sup>)]
  - 14.013 [charge density (C/m<sup>3</sup>)]
  - 14.014 [compressibility m<sup>2</sup>/N]
  - 14.015 [conductance (S)]
  - 14.016 [conductivity (S/m)]
  - 14.017 [density (kg/m<sup>3</sup>)]
  - 14.018 [elec. charge (C)]
  - 14.019 [elec. current (A)]
  - 14.020 [current density (A/m<sup>2</sup>)]

# ABB i-bus<sup>®</sup> KNX

## Parameters

- 14.021 [elec. dipole moment (Cm)]
- 14.022 [elec. displacement (C/m<sup>2</sup>)]
- 14.023 [elec. field strength (V/m)]
- 14.024 [elec. flux (C)]
- 14.025 [elec. flux density (C/m<sup>2</sup>)]
- 14.026 [elec. polarization (C/m<sup>2</sup>)]
- 14.027 [elec. potential (V)]
- 14.028 [elec. potential difference (V)]
- 14.029 [electromag. moment (Am<sup>2</sup>)]
- 14.030 [elec. force (V)]
- 14.031 [energy (J)]
- 14.032 [force (N)]
- 14.033 [frequency (Hz)]
- 14.034 [angular frequency (rad/s)]
- 14.035 [heat capacity (J/K)]
- 14.036 [heat flux (W)]
- 14.037 [quantity of heat (J)]
- 14.038 [resistance (Ω)]
- 14.039 [length (m)]
- 14.040 [quantity of light (J)]
- 14.041 [brightness (cd/m<sup>2</sup>)]
- 14.042 [luminous flux (lm)]
- 14.043 [luminosity (cd)]
- 14.044 [magnetic field strength (A/m)]
- 14.045 [magnetic flux (Wb)]
- 14.046 [magnetic flux density (T)]
- 14.047 [magnetic moment (Am<sup>2</sup>)]
- 14.048 [magnetic polarization (T)]
- 14.049 [magnetization (A/m)]
- 14.050 [magnetomotive force (A)]
- 14.051 [mass (kg)]
- 14.052 [mass flow rate (kg/s)]
- 14.053 [moment (N/s)]
- 14.054 [phase angle (rad)]
- 14.055 [phase angle (°)]



# ABB i-bus<sup>®</sup> KNX Parameters

- 14.056 [power (W)]
- 14.057 [power factor ( $\cos \Phi$ )]
- 14.058 [pressure (Pa)]
- 14.059 [susceptance ( $\Omega$ )]
- 14.060 [resistance ( $\Omega$ )]
- 14.061 [spec.elec. resistance ( $\Omega\text{m}$ )]
- 14.062 [self-inductance (H)]
- 14.063 [solid angle (sr)]
- 14.064 [volume ( $\text{W}/\text{m}^2$ )]
- 14.065 [velocity (m/s)]
- 14.066 [load (Pa)]
- 14.067 [surface tension (N/m)]
- 14.068 [temperature ( $^{\circ}\text{C}$ )]
- 14.069 [absolute temperature ( $^{\circ}\text{C}$ )]
- 14.070 [temperature difference (K)]
- 14.071 [heat capacity (J/K)]
- 14.072 [heat conductivity (W/mK)]
- 14.073 [thermoelectrical energy (V/K)]
- 14.074 [time (s)]
- 14.075 [torque (Nm)]
- 14.076 [volume ( $\text{m}^3$ )]
- 14.077 [flow rate ( $\text{m}^3/\text{s}$ )]
- 14.078 [weight (N)]
- 14.079 [work (J)]

You will find further information on the data point types in [chapter 4.7 Data point types](#).

# ABB i-bus<sup>®</sup> KNX Parameters

## 7.20.3

### Sockets



Overview of the ASM sockets for linking to other modules:

Type	Object name	Data type
Input	Trend1	Configuration-dependent
Input	Trend2	Configuration-dependent
Input	Trend3	Configuration-dependent
Input	Trend4	Configuration-dependent
Input	Trend5	Configuration-dependent

#### Input sockets

Object name	Data type
<b>Trend1</b>	<b>Configuration-dependent</b>
This input socket is always available. Input for recorded value 1.  Signal value: Configuration-dependent	
<b>Trend2</b>	<b>Configuration-dependent</b>
The module has this input socket if the 2 option or greater is selected for the <a href="#">Number of trends</a> parameter. Input for recorded value 2.  Signal value: Configuration-dependent	
<b>Trend3</b>	<b>Configuration-dependent</b>
The module has this input socket if the 3 option or greater is selected for the <a href="#">Number of trends</a> parameter. Input for recorded value 3.  Signal value: Configuration-dependent	
<b>Trend4</b>	<b>Configuration-dependent</b>
The module has this input socket if the 4 option or greater is selected for the <a href="#">Number of trends</a> parameter. Input for recorded value 4.  Signal value: Configuration-dependent	
<b>Trend5</b>	<b>Configuration-dependent</b>
The module has this input socket if the 5 option is selected for the <a href="#">Number of trends</a> parameter. Input for recorded value 5.  Signal value: Configuration-dependent	

# ABB i-bus<sup>®</sup> KNX Parameters

## **Output sockets**

None

### **7.20.4**

#### **Group objects**

No objects available

### **7.20.5**

#### **BACnet objects**

No objects available

# ABB i-bus<sup>®</sup> KNX Parameters

7.20.6

## Web user interface

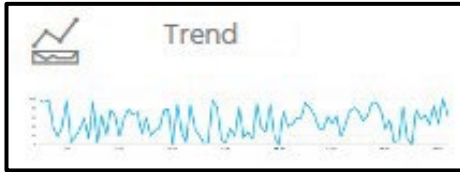

Open the detailed view of the ASM by clicking the ASM's tile.

The user interface has the following layout and functions:

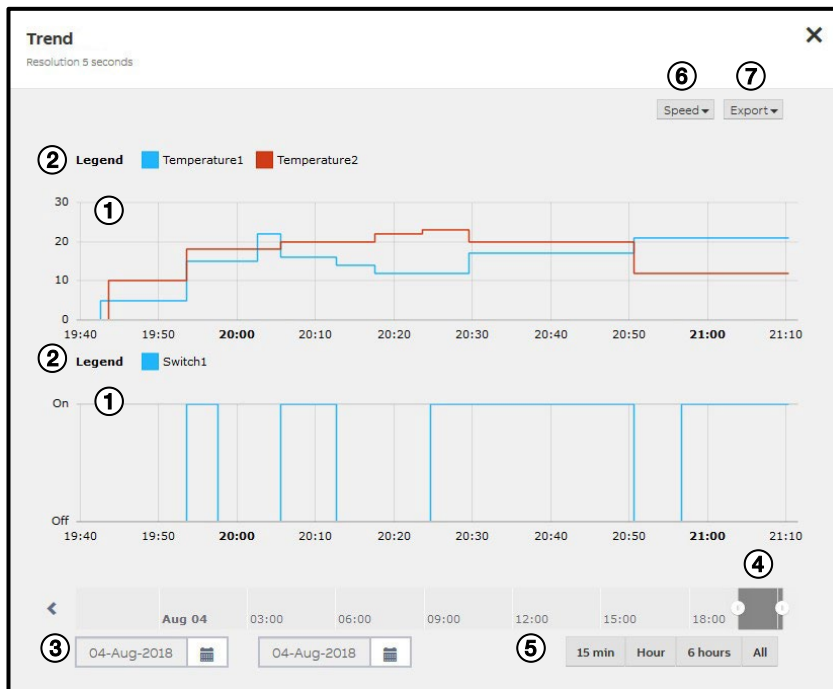

# ABB i-bus<sup>®</sup> KNX

## Parameters

### **Chart area ①**

The data recorded are displayed graphically in the chart area; you can display detailed values by pointing using the mouse (mouseover). Click and drag to select a specific area; this area is displayed larger on releasing the mouse button (zoom). The possible zoom settings are dependent on the recording duration selected and the recording frequency. You can hide and show values by clicking the related marker in the *Legend* ② section. A dedicated diagram area is displayed for each data point type used. If several objects with the same data point type are recorded, these are displayed in the same chart area with different colors.

### **Calendar function ③**

Used to enter the required period (from/to).

### **Slider ④**

Used to limit and move the required period.

### **Quick selection ⑤**

Direct selection of standard display periods. The presets are shown dynamically, depending on the duration of the recording.

# ABB i-bus<sup>®</sup> KNX

## Parameters

### Chart type ⑥

This parameter determines how the points measured are displayed:

- Line: The points measured are connected by a straight line. These lines are theoretical and do not represent the values present at this time (linear interpolation).
- Column: Each point measured is displayed as a column.
- Level: The points measured are connected by a line where the line is at the value of the previous point measured. These lines are theoretical and do not represent the values present at this time (linear interpolation).

### Export ⑦

You can print the trends using this function, or export them to the file formats PNG, JPG, PDF, XLSX, CSV, JSON. Only the period actually displayed in the chart area is exported.

Newly recorded values are not added to the chart while the web user interface for this module is open. Instead a message appears in the top right corner as soon as new values are available. The new values can be displayed by closing and opening the web user interface view for the module.

## 8 Group objects

### 8.1 Summary of group objects

**Note**

The group objects, with the exception of the general group objects, do not have fixed numbers. The numbers are assigned dynamically in ETS. For this reason the group objects can be sorted by name in ETS

**Note**

There is only an overview of the general group objects at this point. The tables of ASM-specific group objects are given in chapter 7 in the related ASM description.

No.	Object function	Name	Data point type (DPT)	Length	Flags					
					C	R	W	T	U	I
2001	Request time	Device clock	1.017	1 bit	(x)				(x)	
2002	Date	Device clock	11.001	3 bytes	x	x	(x)	x		
2003	Time	Device clock	10.001	3 bytes	x	x	(x)	x		
2004	Date/Time	Device clock	19.001	8 bytes	x	x	(x)	x		
Variable	Variable	ASM name	Variable	Variable						

Table 12: Summary of group objects

# ABB i-bus<sup>®</sup> KNX

## Group objects

### 8.2 Group objects, general

No.	Object function	Name	Data type	Flags
<b>2001</b>	<b>Request time</b>	<b>Device clock</b>	<b>1 bit DPT 1.017</b>	<b>(C, T)</b>
This group object requests the date/time from a time master after device start. 30 seconds after the start this group object will send the value 1.				
<b>2002</b>	<b>Date</b>	<b>Device clock</b>	<b>3 bytes DPT 11.001</b>	<b>C, R, (W), T</b>
This group object receives the date from KNX if KNX was selected as the clock synchronization source in the DCA device settings. In all other cases the device date can be sent on the bus via this group object.				
<b>2003</b>	<b>Time</b>	<b>Device clock</b>	<b>3 bytes DPT 10.001</b>	<b>C, R, (W), T</b>
This group object receives the time from KNX if KNX was selected as the clock synchronization source in the DCA device settings. In all other cases the device time can be sent on the bus via this group object. Only time information is evaluated. Day of the week information is not taken into account.				
<b>2004</b>	<b>Date/Time</b>	<b>Device clock</b>	<b>8 bytes DPT 19.001</b>	<b>C, R, (W), T</b>
This group object receives the combined time and date from KNX if KNX was selected as the clock synchronization source in the DCA device settings. In all other cases the combined device date can be sent on the bus via this group object. Only date and time is evaluated. Other information provided by this data point (e.g. year or weekday) is not taken into account.				

Table 13: Group objects



# ABB i-bus<sup>®</sup> KNX

## Operation

### **9**            **Operation**

#### **9.1**           **Manual operation**

You can restart the device by pressing the Reset button. See [chapter 4.6.4, Device restart](#).

## 9.2 Web user interface

### 9.2.1 Menu bar



#### **Building**

Opens the dashboard with an overview of the ASMs installed.

#### **Settings**

Opens the device settings. See [chapter 7.2.3, Web user interface device settings](#). The device settings are only visible for the "admin" user.

#### **Clock**

Displays the device clock. If there are problems with the time synchronization, the clock is displayed in red.

#### **Messages**

Opens the device messages. Only the "admin" can delete these messages.

#### **User**

Displays the user logged in. You can log out and change your password using the menu. Passwords can also be changed in the DCA device settings, see [chapter 7.2.2.4, WebUI – Users parameter page](#).

#### **Language**

Selects the language for the web user interface. This setting is saved for each user.

#### **Device information**

Opens the version number and the legal information on the device.

#### **Login/Logout**

For logging in and out the user.

# ABB i-bus<sup>®</sup> KNX

## Operation

### 9.2.2 Building dashboard

The ASMs and containers are displayed in the same layout as in ETS DCA.

All ASMs for which the user logged in does not have rights are hidden, see [chapter 7.3.3, Web user interface](#). Any containers that are empty as a result are also hidden.

### 9.2.3 Navigation menu

The navigation menu shows the structure of the dashboard based on the containers created in ETS. The navigation menu is generated automatically.

If you select a container, the dashboard scrolls to this point. If you scroll in the dashboard, the actual position in the navigation menu is displayed.

Hide the navigation menu by clicking the  button on the left of the screen.

### 9.2.4 ASM detailed view

Open the detailed view of the ASM by clicking the ASM's tile. The ASM detailed views are explained in chapter 7 in the descriptions of the individual ASMs.

Several users can be logged in at the same time and make changes in the ASM detailed views. These changes are then immediately visible to the other users. The latest change is always applied. There is no user priority.

After device start, all initial values and restored values and states are marked with the  symbol. The symbol is only hidden once a valid value has been received.



# ABB i-bus<sup>®</sup> KNX

## Maintenance and cleaning

### **10 Maintenance and cleaning**

#### **10.1 Maintenance**

The device is maintenance-free. In the event of damage, e.g. during transport and/or storage, repairs are not allowed to be made.

#### **10.2 Cleaning**

Disconnect the device from the supply of electrical power before cleaning. If devices become dirty, they can be cleaned using a dry cloth or a cloth dampened with a soapy solution. Corrosive agents or solutions must never be used.

### 10.3 Software update

The device manufacturer may make available new device software on the manufacturer's web site. This can contain bug fixes, performance improvements and new functions.

Please regularly check for new software versions.

You will find the current version number for DCA using the "About" button on the DCA menu bar, see [chapter 6.5.6, Menu bar](#).

For further information on updating DCA, see ETS help.

You will find the current version of the device software (firmware) on the web user interface in "Device information" on the menu bar (see [chapter 9.2.1, Menu bar](#)) or via the ETS function "Device information".

The device software is updated via the web user interface, see [chapter 7.2.3.2, Firmware update parameter page](#). The device configuration is deleted during the update. Only the physical KNX address and the IP configuration are retained. All values and states saved are lost. The configuration must be programmed again by means of an ETS download.

You will find the current version of the ETS application program in ETS in the device properties. For further information on updating the ETS application program, see ETS help.

### 10.4 Support

If you have problems with your device, support at the device manufacturer can use the following to analyze the problem:

- ETS log files. See ETS help.
- Messages on the web user interface. See [chapter 9.2.1, Menu bar](#).
- Monitor mode for the Automation ASM. See [chapter 7.2.3.4, Monitor mode parameter page](#).
- Accessing the device using SSH. See [chapter 7.2.3.5, SSH access parameter page](#).
- Device log files. See [chapter 7.2.3.6, Log settings parameter page](#).

# ABB i-bus<sup>®</sup> KNX

## Disassembly and disposal

### 11 Disassembly and disposal

#### 11.1 Removal

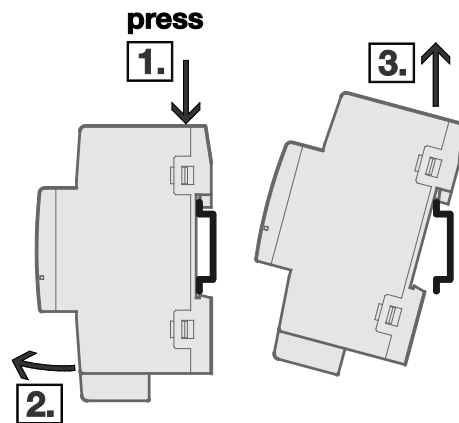

Fig. 10: Removal

1. Press on the top of the device.
2. Release the bottom of the device from the DIN rail.
3. Lift the device up and off the DIN rail.

# ABB i-bus<sup>®</sup> KNX

## Disassembly and disposal

### 11.2 Environment

Consider environmental protection.

Used electrical and electronic devices must not be disposed of as domestic waste.

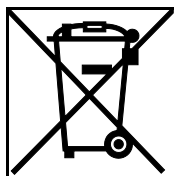

The device contains valuable resources that can be recycled. Therefore, please take the device to a suitable recycling center. All packaging materials and devices are provided with markings and test seals for proper disposal. Always dispose of packaging material and electrical devices or their components at collection points or disposal companies authorized for this purpose. The products comply with the statutory requirements, particularly the law on electrical and electronic equipment and the REACH regulation. (EU directive 2012/19/EU WEEE and 2011/65/EU RoHS) (EU REACH regulation and the law implementing the regulation (EC) no.1907/2006)

### 11.3 Deleting data

Please perform a factory reset on taking the device out of use to delete the configuration and the private data saved on the device. See [chapter 4.6.5, Factory settings](#).



# ABB i-bus<sup>®</sup> KNX

## Planning and application

### 12 Planning and application

In this chapter you will find some tips and application examples for practical use of the device.

#### 12.1 Application examples

You will find application examples in the engineering guides at [www.abb.com/knx](http://www.abb.com/knx).

#### 12.2 Several devices per system

Several devices can be used per system. These can exchange data with each other using group addresses. You can refer to other devices in the web user interface with the aid of the Link ASM.

Configurations can be copied between devices. See [chapter 6.5.8. Copying, cutting and pasting](#).



### 13 Appendix

#### 13.1 Scope of delivery

The application controller is supplied with the following parts. The items delivered should be checked against the list below

- 1 application controller, alternatively:
  - AC/S 1.1.1 Application Controller, Basic
  - AC/S 1.2.1 Application Controller, BACnet
- 1 x installation and operating instructions
- 1 x bus connection terminal (red/black)
- 1x KNX connection cover cap

# ABB i-bus<sup>®</sup> KNX

## Appendix

### 13.2 Notes

# ABB i-bus<sup>®</sup> KNX

## Appendix

### Notes

# ABB i-bus<sup>®</sup> KNX

## Appendix

### Notes



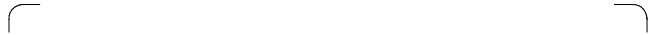

---

**ABB STOTZ-KONTAKT GmbH**  
Eppelheimer Straße 82  
69123 Heidelberg, Germany  
Phone number: +49 (0)6221 701 607  
Fax: +49 (0)6221 701 724  
E-mail: [knx.marketing@de.abb.com](mailto:knx.marketing@de.abb.com)

**More information and  
regional contact person**  
[www.abb.de/knx](http://www.abb.de/knx)  
[www.abb.com/knx](http://www.abb.com/knx)

---

© Copyright 2024 ABB. We reserve the right to make technical changes to the products as well as amendments to the content of this document at any time without advance notice. The agreed properties are definitive for any orders placed.

ABB AG does not accept any responsibility whatsoever for potential errors or possible lack of information in this document.

We reserve all rights in this document and in the subject matter and illustrations contained therein. Reproduction, transfer to third parties or processing of the content – including sections thereof – is not permitted without prior express written permission from ABB AG.