

# KNX Technical Reference Manual

## ABB i-Bus<sup>®</sup> KNX

**Busch-Watchdog**  
6179/01-...-500  
220 MasterLINE KNX  
6179/02-...-500  
220 MasterLINE KNX *premium*



### Everything under control

The Busch-Watchdog reliably monitors the outdoor areas of buildings and switches the light on automatically when it detects movement. This ensures that residents and guests are welcomed and unwelcome intruders are kept out.

The Busch-Watchdog can be installed anywhere on the property - leaving no angle that is not monitored.

Especially convenient is the rearfield detection in the front door area. Here the Busch-Watchdog provides light when one steps out of the door, yet is still "behind" the movement detector.

Even when you are not at home for several days, the Busch-Watchdog will independently handle switching processes to convincingly simulate your presence in the home. The integration of the Busch-Watchdog into the KNX bus system permits functions to be implemented that go beyond the mere switching of the exterior lighting. It also allows the light in the house to be switched on, a blind to be moved or music to be played when movement is detected. Such "signs of life" will put any potential burglars to flight.

1	Safety.....	5
2	Intended use .....	5
3	User information.....	5
4	Environment.....	5
5	Operation .....	6
5.1	Control elements.....	6
5.2	Standard operation .....	6
5.3	Standard operation (time- and brightness dependent).....	7
6	Remote control.....	8
6.1	Control elements of the remote control .....	8
6.2	Technical data of the remote control.....	8
6.3	Commissioning of remote control.....	9
6.4	Battery change of remote control .....	9
7	Technical data.....	10
8	Setup and function .....	11
8.1	Features of function and equipment.....	11
8.2	Technology .....	12
9	Installation and electrical connection .....	15
9.1	Operational safety/interference factors .....	15
9.2	Detection ranges .....	16
9.2.1	Coverage .....	16
9.2.2	Installation sites .....	17
9.3	Mounting .....	18
9.3.1	Preparing the installation.....	18
9.3.2	Water drainage .....	19
9.3.3	Mounting steps.....	20
9.4	Electrical connection .....	21
10	Commissioning .....	22
10.1	Setting / limiting the transmission range and the detection range .....	22
10.2	Software application.....	23
10.3	Programming mode.....	23
10.4	Activation test.....	24
11	"Movement detector" application.....	25
11.1	Parameters .....	25
11.1.1	Activation / linking internal or external brightness evaluation .....	25
11.1.2	Activation of switch-off delay object .....	25
11.1.3	Output type .....	25
11.1.4	Operation mode .....	25
11.1.5	Operating mode of the movement detector.....	25
11.1.6	Input actuator status.....	25
11.1.7	Input Slave .....	25
11.1.8	Input Slave takes the brightness into consideration .....	26
11.1.9	Setting the brightness-value threshold via .....	26
11.1.10	Setting the switch-off delay via.....	26
11.1.11	Overwrite settings during download .....	26
11.1.12	Sensitivity of the watchdog.....	26
11.1.13	Enable with .....	26
11.1.14	Brightness threshold internal (lux).....	26
11.1.15	Detection independent of brightness after return of bus voltage .....	26
11.1.16	Switch-off delay.....	27
11.1.17	External push-button object .....	27
11.1.18	Object for switch-off delay.....	27
11.1.19	Object for external brightness threshold.....	27
11.1.20	Object for detection independent of brightness.....	27
11.1.21	Object for internal brightness threshold.....	27

11.1.22	Manual mode object.....	27
11.1.23	Activating sensors.....	27
11.1.24	Status LED.....	27
11.1.25	Pause time (ms).....	28
11.1.26	Value for switching off.....	28
11.1.27	Value for switching on.....	28
11.1.28	Cyclical repeat time (s).....	28
11.2	Objects.....	29
12	"Twilight switch" application.....	30
12.1	Parameters.....	30
12.1.1	Cool-down time of the lamp.....	30
12.1.2	Number of actuator status inputs.....	30
12.1.3	Number of twilight thresholds.....	30
12.1.4	Warm-up time of the lamp.....	30
12.1.5	Output brightness/twilight switch sends at.....	30
12.1.6	Twilight threshold (lux).....	30
12.1.7	Overwrite settings during download.....	30
12.1.8	Enable object brightness/twilight switch.....	30
12.1.9	Brightness detection.....	30
12.1.10	Hysteresis.....	30
12.1.11	Lamps in the detection range.....	31
12.1.12	Minimum duration of undershoot.....	31
12.1.13	Minimum duration of overshoot.....	31
12.1.14	Object output ambient brightness (lux).....	31
12.1.15	Object input brightness/twilight threshold.....	31
12.1.16	Threshold programmable via the bus (1 bit).....	31
12.2	Objects.....	32
13	"Brightness switch" application.....	33
13.1	Parameters.....	33
13.1.1	Cool-down time of the lamp.....	33
13.1.2	Number of actuator status inputs.....	33
13.1.3	Number of brightness/twilight thresholds.....	33
13.1.4	Warm-up time of the lamp.....	33
13.1.5	Output brightness/twilight switch sends at.....	33
13.1.6	Overwrite settings during download.....	33
13.1.7	Enable object brightness/twilight switch.....	33
13.1.8	Brightness/twilight threshold (lux).....	33
13.1.9	Brightness detection.....	33
13.1.10	Hysteresis.....	34
13.1.11	Lamps in the detection range.....	34
13.1.12	Minimum duration of overshoot.....	34
13.1.13	Minimum duration of undershoot.....	34
13.1.14	Object output ambient brightness (lux).....	34
13.1.15	Object input brightness/twilight threshold.....	34
13.1.16	Threshold programmable via the bus (1 bit).....	34
13.2	Objects.....	35
14	"Temperature switch" application.....	36
14.1	Parameters.....	36
14.1.1	Number of temperature thresholds.....	36
14.1.2	Output temperature switch sends at.....	36
14.1.3	Overwrite settings during download.....	36
14.1.4	Enable object temperature switch.....	36
14.1.5	Hysteresis.....	36
14.1.6	Minimum duration of overshoot.....	36
14.1.7	Minimum duration of undershoot.....	36
14.1.8	Object input temperature threshold.....	36

14.1.9	Threshold programmable via the bus (1 bit).....	36
14.1.10	Temperature reading.....	36
14.1.11	Temperature threshold °C.....	37
14.2	Objects.....	38

## 1 Safety



### Warning

#### Electric voltage!

Risk of death and fire due to electrical voltage of 230 V.

- Work on the 230V supply system may only be performed by authorised electricians!
- Disconnect the mains power supply prior to installation and/or disassembly!

## 2 Intended use

The Busch-Watchdogs are passive infrared movement detectors which switch loads via the KNX bus when sources of heat move within its detection range.

Busch-Watchdog is not an intrusion or attack alarm.

## 3 User information

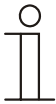

### Disclaimer

The content of this printed material has been checked for compliance with hardware and software. However, no liability can be assumed for any deviations that may still occur. Any necessary corrections will be implemented in future versions of this manual.

Please advise us of any suggestions you may have concerning the manual's improvement.

## 4 Environment



### Consider the protection of the environment!

Used electric and electronic devices must not be disposed of with domestic waste.

- The device contains valuable raw materials which can be recycled. Therefore, dispose of the device at the appropriate collecting depot.

All packaging materials and devices bear the markings and test seals for proper disposal. Always dispose of the packaging material and electric devices and their components via the authorized collecting depots and disposal companies.

The products meet the legal requirements, in particular the laws governing electronic and electrical devices and the REACH ordinance.

(EU Directive 2002/96/EC WEEE and 2002/95/EC RoHS)

(EU REACH ordinance and law for the implementation of the ordinance (EC) No.1907/2006)

## 5 Operation

### 5.1 Control elements

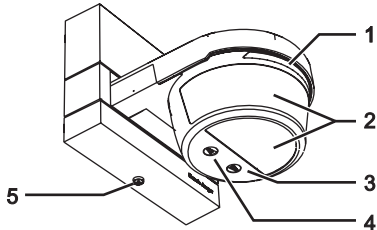

Fig. 1: Control elements

No.	Function	
1	LED	
	<b>220 MasterLINE</b>	<b>220 MasterLINE premium</b>
	On - Programming mode	On - Programming mode
	Special flashing (repeated cyclically) - Detection in test mode	Special flashing (repeated cyclically) - Detection in test mode
	—	Briefly lit up - Incoming IR signals
	Continuous flashing - Special boot mode in the event of a fault or simultaneous programming and test mode of the potentiometers during a reset	Continuous flashing - Special boot mode in the event of a fault or simultaneous programming and test mode of the potentiometers during a reset
2	Lens	
3	Trim potentiometer for switch-off delay, programming mode	
4	Trim potentiometer for brightness value, test/standard operation	
5	Screw for dismantling safety	

### 5.2 Standard operation

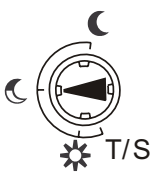

Fig. 2: Standard operation

The lighting during twilight remains switched on for 3 minutes after the last detection (at a twilight value of 5 lux).



#### Note

After activating the mains supply voltage the device remains in test mode for 10 minutes (see chapter "Activation test").

### 5.3 Standard operation (time- and brightness dependent)



Fig. 3:

Set the values for the activation threshold (brightness) and the switch-off delay (on period of the light after the last detection).

Icon	Function
	Switching at approximately 300 lux
	Switching at nightfall (approximately 5 lux)
	Switching during darkness
Prog.	Programming mode

## 6 Remote control

The Busch-Watchdog 6179/02-...-500 220 MasterLINE premium can be operated via the remote control.

### 6.1 Control elements of the remote control

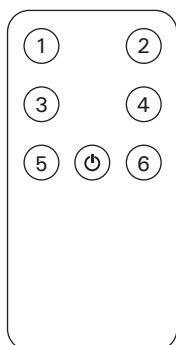

Fig. 4: Control elements

The buttons can be freely programmed via the software application (ETS / Power-Tool).

### 6.2 Technical data of the remote control

Designation	Value
Operating voltage:	3 V DC
Battery type:	CR 2025
Battery life:	Approximately 2 years
Coverage:	Maximum of 6 m
Protection type:	IP 40
Operating temperature:	0 ... 45°C



### 6.3 Commissioning of remote control

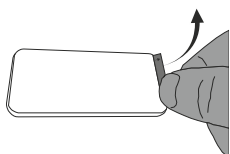

Fig. 5: Removing the protective foil from the battery

Remove the protective foil from the battery before commissioning.

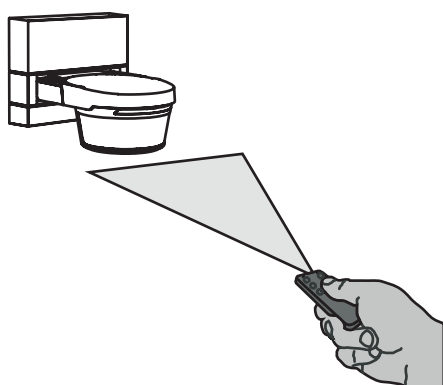

Fig. 6: Programming the remote control

De-energize the Busch-Watchdog for at least 30 seconds.

- Press any button on the remote control for at least 3 seconds within the period of 10 minutes after activating the power on the Busch-Watchdog.
  - The remote control will then automatically connect itself to the Busch-Watchdog.
  - The Busch-Watchdog flashes if the reception is correct.
  - Repeat these steps to program a maximum of 14 additional remote controls.

### 6.4 Battery change of remote control

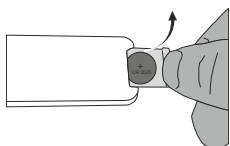

Fig. 7: Changing the battery

1. Pull the battery holder out of the remote control.
2. Insert a new battery of type 2025.
  - The plus pole of the battery (+) must be on top.
3. Push the battery holder back into the device.

## 7 Technical data

Designation	220 MasterLINE	220 MasterLINE <i>premium</i>
Power supply: (via bus line)	24 V DC	24 V DC
Bus subscribers:	1 (< 12 mA)	1 (< 12 mA)
KNX connection	Bus connecting terminal, screwless	Bus connecting terminal, screwless
Monitoring density:	92 sectors with 368 switching segments	92 sectors with 368 switching segments
Adjustable switch-off delay		
• via potentiometer (only for movement detectors)	10 seconds ... 30 minutes	10 seconds ... 30 minutes
• Parameterizable via software (seconds to hours)	10 seconds ... 18 hours	10 seconds ... 18 hours
Switch-on time after switch-off (parameterizable via software)	0.1 seconds ... 60 seconds	0.1 seconds ... 60 seconds
Adjustable brightness range		
• via potentiometer (only for movement detector)	~ 1 ... 300 lux	~ 1 ... 300 lux
• parameterizable via software: (movement detector)	1 ... 1000 lux	1 ... 1000 lux
• parameterizable via software: (twilight switch)	1 ... 1000 lux	1 ... 1000 lux
• parameterizable via software: (brightness switch)	—	1000 ... 80000 lux
Horizontal detection:	220°	220°
Maximum transmission range: (installed 2.5 m high)	16 m	16 m
Detection range:	<ul style="list-style-type: none"> <li>• Frontal: 16 m</li> <li>• Lateral: 16 m</li> </ul>	<ul style="list-style-type: none"> <li>• Frontal: 16 m</li> <li>• Lateral: 16 m</li> </ul>
Control elements:	<ul style="list-style-type: none"> <li>2 Trim potentiometer</li> <li>• Brightness limit value, Test/standard operation</li> <li>• Switch-off delay, programming mode</li> </ul>	<ul style="list-style-type: none"> <li>2 Trim potentiometer</li> <li>• Brightness limit value, Test/standard operation</li> <li>• Switch-off delay, programming mode</li> </ul>
Protection type:	IP 55	IP 55
Temperature range:	-25 ... 55°C	-25 ... 55°C
Dimensions: (H x W x D)	115 mm x 125 mm x 141 mm	115 mm x 125 mm x 141 mm
Remote control possible via:	—	6179-500
KNX product standard	EN 60669-2-1	EN 60669-2-1

## 8 Setup and function

### 8.1 Features of function and equipment

<b>Busch-Watchdog</b>	<b>220 MasterLINE</b>	<b>220 MasterLINE premium</b>
Detection angle	220°	220°
Monitoring levels	4	4
Creep zone protection	•	•
Rearfield detection	•	•
Zone 1	•	•
Transmission range frontal (maximum)	1 – 16 m	1 – 16 m
Transmission range lateral (maximum)	1 – 16 m	1 – 16 m
Zone 2	•	•
Transmission range frontal (maximum)	1 m	1 m
Transmission range lateral (maximum)	1 m	1 m
Sensitivity adjustable	•	•
Automatic range stabilisation	•	•
Dazzleproof	•	•
Integrated test function	•	•
Temperature range	–25 ...55°C	–25 ...55°C
Twilight sensor	•	•
Switch-off delay	•	•
Forced switch-off after 90 minutes	•	•
Short-time pulse (1 s)	•	•
Water-resistant	IP 55	IP 55
Wall mounting	•	•
Ceiling mounting <sup>1</sup>	•	•
Corner mounting <sup>1</sup>	•	•
Blind (protective foil)	•	•
Remote control operated	—	•
Temperature switch (triple threshold switch)	—	•
Brightness switch	—	•
Twilight switch	•	•
Movement channels	2	4
Freely programmable IR channels	—	7

<sup>1</sup> With ceiling / corner adapter 6868-xxx

The individual functions are explained in the following.

## 8.2 Technology

### Basics

The Busch-Watchdog is a passive infrared movement detector and detects invisible infrared heat radiation. If the registered energy pattern changes as the result of movement, a pulse is activated. The transmission range depends on the intensity of the infrared radiation and on the direction of movement. The reception is influenced by weather conditions. The sophisticated electronics of the Busch-Watchdog detects this and compensates for the fluctuations in the transmission range. Detection is impaired by obstacles such as glass or plants.

### The detection principle

All warm bodies give off infrared heat radiation. The more distinctly the infrared heat radiation stands out from its surroundings, the better the sensors used in the Busch-Watchdog detect this infrared heat radiation. The Busch-Watchdog responds to fast and large changes in temperature. Slow changes in temperature and constant temperatures, such as the cooling of a car engine, do not trigger a pulse. If a person moves directly towards the sensor, the heat radiation gets slowly and constantly more intensive, and the unit does not, therefore, activate immediately. That is why the Busch-Watchdog should preferably be mounted crosswise to the direction of movement. Humidity, such as fog, can reflect the infrared radiation and reduce the sensitivity of the sensor.

### Optics

The range and the detection angle is mainly determined by the optics of a movement detector, i.e. the arrangement and design of the sensors and of the lens used. In the Busch-Watchdog it is two highly sensitive sensors in connection with a mirror system and a lens that is optimally adapted to it which determine the detection range of 220°. The lens and the mirror system bundle the infrared radiation striking the device and project it onto the sensor. The sensitivity to movement within the detection range is determined mainly by the number and optical design of the lens segments. The available range is the result of the size of the lens segments (optical magnification) and the electrical amplification factor. The Busch-Watchdog also offers the option of monitoring the frame "backwards" without loss of frontal range by mounting it directly above doors or windows. This is especially convenient when leaving the house.

The following factors should be taken into account during the planning stage:

The installation site should be chosen in such away that the most frequent direction of movement is crosswise to the detection range.

A mounting height of 2.5 m ensures an optimum surveillance function and is the basic height for the technical specifications of the transmission range.

### Self-test

A further advantage of the Busch-Watchdog is the integrated testing function. Each time the supply voltage is activated or the device is switched on, a complete self-test is carried out. When the Busch-Watchdog is fully functional, it switches itself on for confirmation for approximately one minute or for the set switch-off delay. The test function is not dependent on brightness. During a test of the normal operating mode the switch-off delay is two seconds when triggered. During an active activation test function the integrated red LED flashes when triggered.

### Detection levels

To fully cover the detection range, the Fresnel lens splits the range into several overlapping levels.

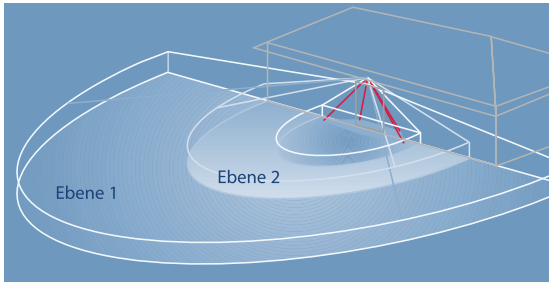

Levels 1 and 2 cover remote detection and ensure uninterrupted detection when the range is entered from the outside.

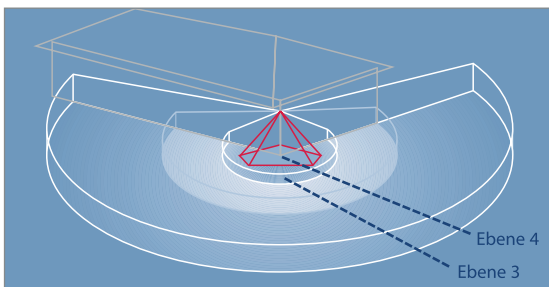

Level 3 covers creep zone protection to prevent undetected entry of the detection range close to the wall.

Level 4 covers the rearfield detection and provides activation when the front door is opened from the inside.

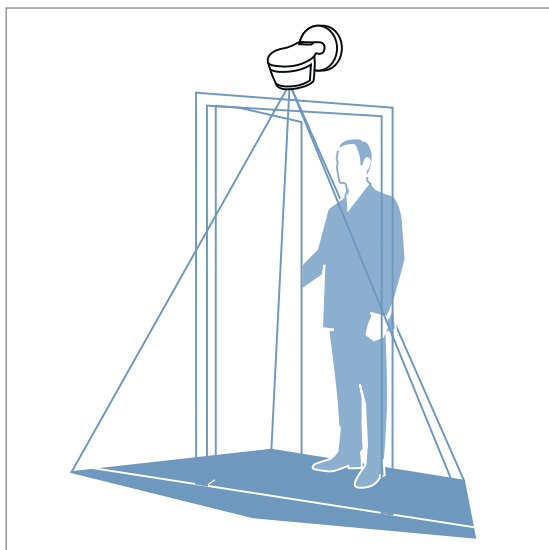

Additional protection for windows and doors up to the wall of the house is guaranteed by the rearfield detection - even when mounted directly above doors and windows.

### Twilight switch (APWB-11)

The twilight switch integrated in the Busch-Watchdog cares for light when the ambient brightness gets too low. At the onset of twilight the Busch-Watchdog responds independent of movement. The device has three channels that can be occupied with the "twilight switch" application independent of each other.

Several setting options are available to implement this function. This allows the brightness value for switching on the light to be supplemented by a hysteresis.

If the ambient brightness value drops below the set value less the hysteresis, the artificial light is switched on. Conversely, the Busch-Watchdog switches off when the brightness-value threshold plus the hysteresis is exceeded. The value for the hysteresis in percent is either added or subtracted to the appropriate twilight threshold. A set value of 300 lx with a hysteresis of 11% results in an upper limit of 333 lx and a bottom limit of 267 lx.

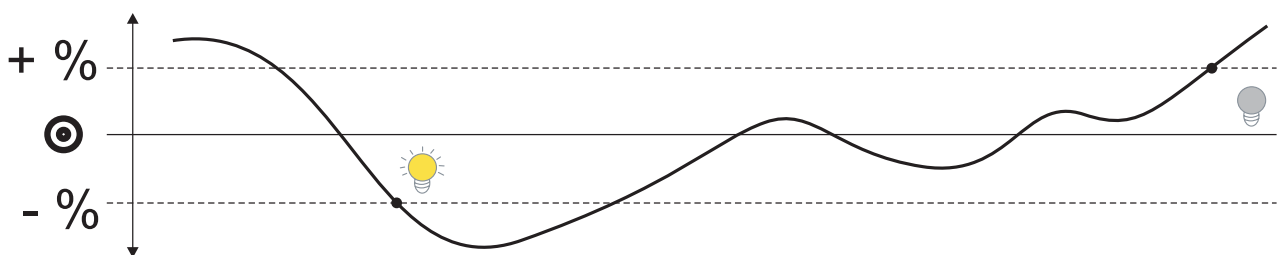

Fig. 8: Hysteresis

A special intelligence of the Busch-Watchdog takes the artificial light content of the surroundings into account. This prevents the lamps from remaining on longer than required.

The twilight switch makes the status inputs available. These must monitor the switching states of the lamps that are in the detection range of the brightness sensor. If such a lamp is switched on, the Busch-Watchdog responds by remembering the switch-on brightness value.

Since the full brightness is not immediately present in some lamps when they are switched on, the time between being switched on and attaining the full brightness must be taken into account. The same applies to switching off. Various lamps also have different warm-up or cool-down periods, which must be taken into account.

It is recommended to send the switch-on and switch-off telegrams to the actuator time-delayed. This ensures that when the brightness-value threshold is briefly exceeded or undershot, lamps are not immediately switched on or off one after the other. Such brief fluctuations of the light conditions can be caused by vehicles or clouds.

## 9 Installation and electrical connection

### 9.1 Operational safety/interference factors

#### External light protection

With the Twilight sensor set to "dark", the Busch-Watchdog could be deactivated by a light source (torch or car headlights). To avoid this situation and increase safety, the Busch-Watchdog leaves its current surveillance function unchanged for 90 seconds if the light conditions suddenly change.

#### Faulty switching

The principle of the passive infrared movement detector means that its function depends on the physical conditions prevailing in the detection range. Moving heat sources always cause triggering when the sensitivity threshold of the Busch-Watchdog is exceeded. Sunlight has a high percentage of natural infrared radiation. If the sun shines onto a bush or a tree in the detection range, for example, and this bush or tree moves in the wind, this may cause a movement detector to trigger. Sunlight reflecting off glass or water, a heat source cooling down (e.g. a lamp mounted nearby) or animals in the detection range can also trigger detection.

#### Range fluctuations

Extreme weather conditions can cause changes in the detection range. High outside temperatures and poor visual conditions due to fog, rain or snow can temporarily reduce the range. Excessively long ranges are caused by sources of extreme heat, such as lorries or busses, or at very low outside temperatures and good visual conditions. Important here is to adapt the detection range to the necessary area during installation with an appropriate inclination of the Busch-Watchdog sensor and possibly adapt the use of the Busch-Watchdog blind. The automatic range stabilization of the Busch-Watchdog counteracts the effects described above; however, it cannot guarantee consistent triggering behaviour under all conditions.

9.2 Detection ranges

9.2.1 Coverage

The transmission range of the sensors is constant. Only the mounting height and the inclination result in different widths at the height of the detection level. This to be planned at a height of 1.5 m. The optimum mounting height is 2.5 m.

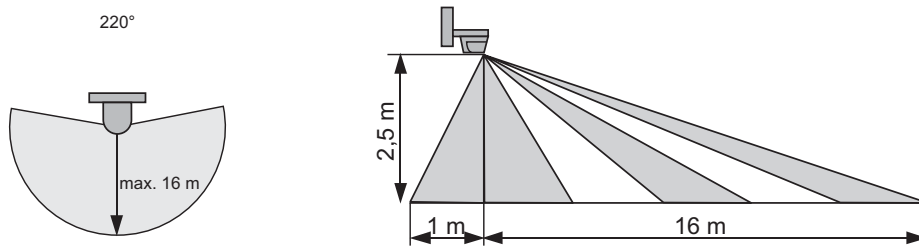

Fig. 9: Transmission range

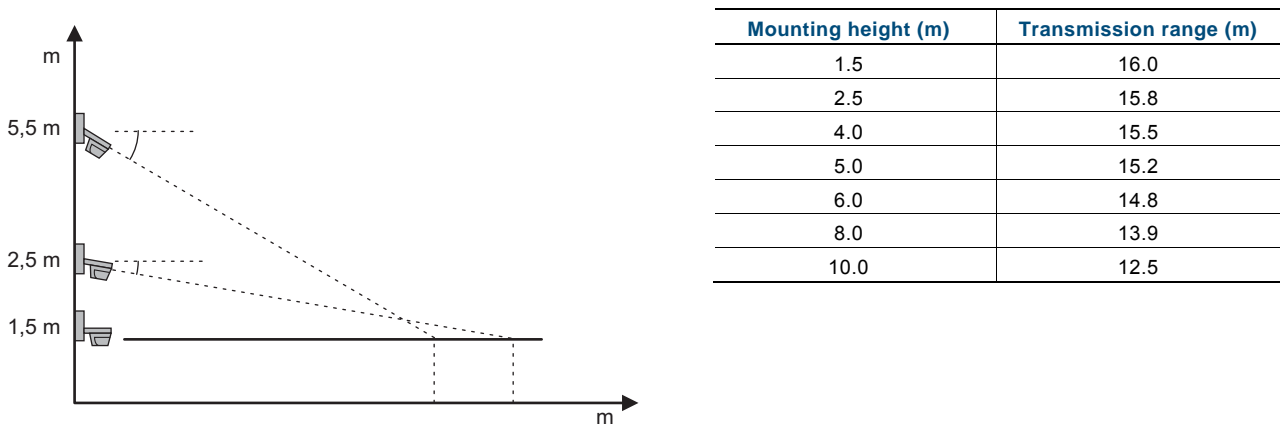

Fig. 10: Loss of transmission range in dependence of mounting height

The transmission range is reduced at a mounting height of over 2.5 m. An inclination of the movement detector leads to losses at close range.



### 9.2.2 Installation sites

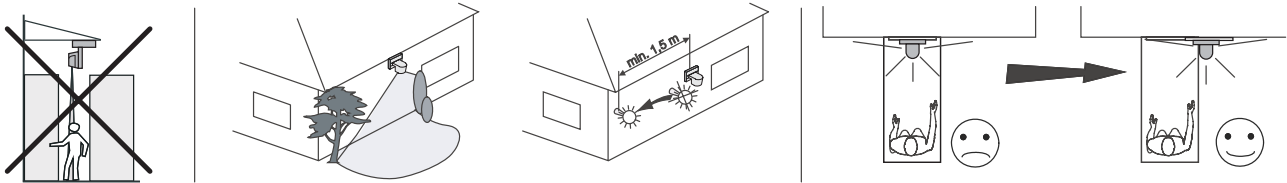

Fig. 11: Installation sites

- Bushes, trees, etc., reduce the detection range.
- Adhere to a minimum distance of 1.5 m when mounting near illuminants.
- The movement detection of the device is optimal if the detection range is intersected by the person to be detected. Therefore, mount the device not above a door, but offset next to it.

### 9.3 Mounting



#### Caution

##### Risk of damaging the device!

The lens of the device is sensitive and can easily sustain damage.

- Do not press on the lens when opening or closing the device.

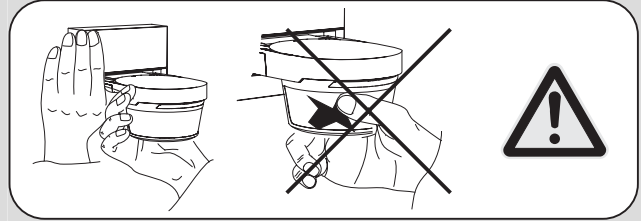

#### 9.3.1 Preparing the installation

To prepare the installation of the device, perform the following steps:

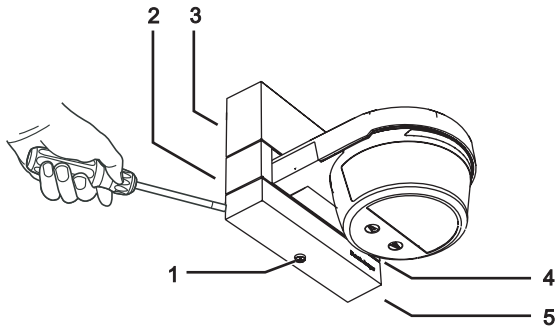

Fig. 12: Preparing the installation

- Remove the locking screw (1) (if installed).
- Press in the clamps (2 - 5) on the sides of the housing with a suitable tool.
- Carefully remove the front of the device.

### 9.3.2 Water drainage

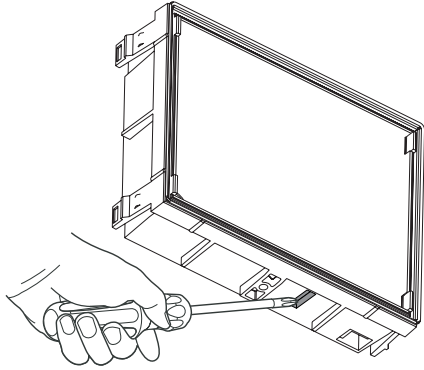

Fig. 13: Water drainage

Depending on where the device is installed, the water drain may have to be opened.

- To do this, pierce the plastic membrane on the bottom of the device.

The installation is prepared.

### 9.3.3 Mounting steps

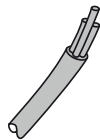

2x 2x 0,8 mm<sup>2</sup>

Fig. 14: KNX cable

- One KNX socket is enclosed!

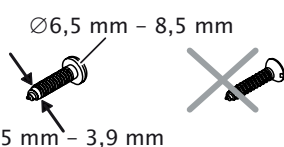

Fig. 15: Mounting screws

- Do not use countersunk head screws for mounting to the wall.

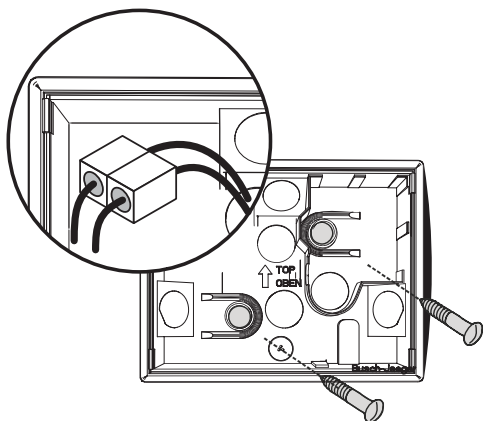

Fig. 16: Mounting the bottom of the device

- The available bolting dimensions of the base may be compatible with existing bores on older versions of the Busch-Watchdog.

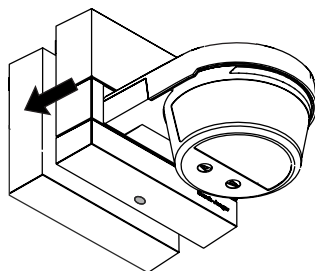

Fig. 17: Attaching the upper part of the device

- Latch the upper part of the device onto the base.

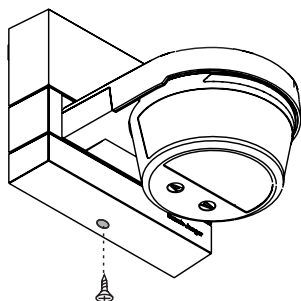

Fig. 18: Securing the device

- Option:  
To protect the device against unauthorized opening, the enclosed screw can be used on the bottom of the device.

#### 9.4 Electrical connection

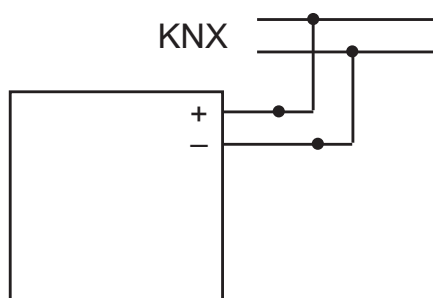

Fig. 19: Connection

Connection of the integrated bus coupler.

## 10 Commissioning

### 10.1 Setting / limiting the transmission range and the detection range



#### Caution

##### Risk of damaging the device!

The lens of the device is sensitive and can easily sustain damage.

- Do not press on the lens when setting the device.

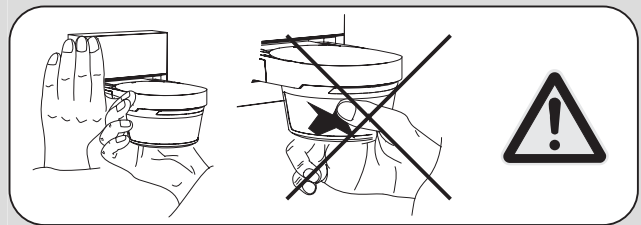

Use the following steps to set the transmission range and the detection range:

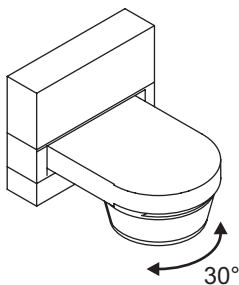

Fig. 20: Adjusting the lateral detection range

1. Adjust the lateral detection range by turning the head of the device.

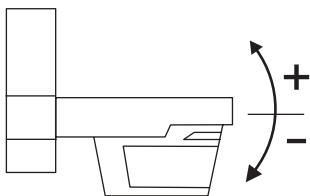

Fig. 21: Adjusting the transmission range

2. Adjust the transmission range by lifting or lowering the head of the device.
  - The minimum transmission range is 6 m.

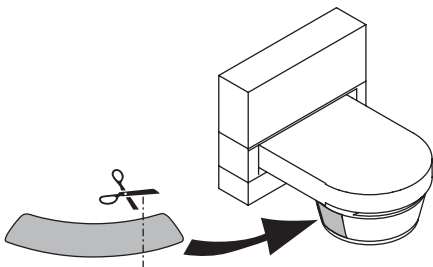

Fig. 22: Adjusting the detection range by masking

3. The range can be specifically limited by gluing on the enclosed foil.
  - Cut the enclosed foil to the size required.
  - The individual sensors can also be faded out via the Power-Tool software application.

The transmission range and the detection range are set.

### 10.2 Software application

Different functions are possible via the software application (ETS / Power-Tool) (For a detailed description of parameters see the Help text in the Power-Tool software and the description of applications from Chapter 11).

### 10.3 Programming mode



Fig. 23: Programming

Programming is started via the software application (ETS). During the procedure the red LED lights up. When the programming mode has been completed it is exited automatically after 15 minutes.

The device does not automatically switch into the programming mode after a reset, even if the selector switch is set on "Prog" (only when it has not been turned out of the "Prog" position). The selector switch must first be turned out of the "Prog" position and then back into it.



#### Note

The test mode cannot be selected together with the programming mode.

## 10.4 Activation test



### Note

The activation test also functions without programming.



Fig. 24: Control elements

To carry out the activation test, perform the following steps:

- Set selector switch to T/S.
  - The device is now in test mode for 10 minutes (daytime operation, switch-off delay 2...9 seconds). In addition, each detection is indicated by a special flashing of the status LED.
  - The device then switches back into standard operating mode (Standard operation = switch-off delay 3 min, brightness 5 lux).
  
- To carry out an additional activation test, set the selector switch out of position T/S and then back to it or interrupt the operating voltage supply for more than 15 seconds.
  - The device is now in test mode for another 10 minutes. Test mode is exited automatically after 10 minutes or by adjusting the brightness.



## 11 "Movement detector" application

### 11.1 Parameters

#### 11.1.1 Activation / linking internal or external brightness evaluation

This parameter is used to specify whether the internal brightness value or the value received via the "External brightness" input is to be used. Both values can also be used simultaneously. In the last instance the detection of movement is active when there is a shortfall of one of the two threshold values. Alternatively, the parameter can also be disabled, so that the movement detector operates independent of brightness.

#### 11.1.2 Activation of switch-off delay object

Values between 10 and 65,535 seconds (approx. 18 hours) can be received via this 2-byte "switch-off delay" communication object.

The value received is stored in the memory of the device and is also retained after the return of bus voltage.

#### 11.1.3 Output type

In master mode On and Off telegrams are sent (to an actuator) dependent on movement. In slave mode On telegrams are sent cyclically (to the extension unit input of a master movement detector) when movement is detected.

#### 11.1.4 Operation mode

Automatic = automatic switch-on and switch-off

Automatic switch-off = manual switch-on and automatic switch-off

Automatic switch-on = automatic switch-on and manual switch-off

In the "Automatic" mode the movement detector switches on automatically when detecting a movement. The switch-off is effected after the set switch-off delay beginning from the most recent detection.

In operating mode "Automatic switch-off" the movement detector must be switched on manually. The switch-off is effected automatically under consideration of the switch-off delay.

In "Automatic switch-on" mode the movement detector switches on automatically when detecting a movement. It switches off at the receipt of an OFF telegram on the "External pushbutton input" object. Note: The movement detector switches off automatically after 6 hours.

Manual switch-on and switch-off is possible in every operating mode via the external push-button input. During manual switch-off the detection of movement is suppressed for the pause time.

#### 11.1.5 Operating mode of the movement detector

Normal = Operation with adjustable brightness-value threshold and switch-off delay.

Standard = Operation with fixed brightness-value threshold (5 lux) and switch-off delay (3 minutes).

Test = Operating mode for determining the detection range (independent of the set brightness-value threshold).

During detection of movement the programming LED flashes and the switch-off delay is less than 10 seconds.

Potentiometer = The operating mode is set via the potentiometer on the device.

#### 11.1.6 Input actuator status

Actuators controlled by the movement detector can send their status to this input (1 bit). Upon the receipt of an Off telegram on the object the detection of movement is suppressed for the specified pause time and the switch-off delay is reset.

#### 11.1.7 Input Slave

Via this input the master movement detector receives the (On) telegrams of the connected slaves or of a push-button.

#### **11.1.8 Input Slave takes the brightness into consideration**

When this parameter is activated, the On telegrams received via the slave input are only taken into consideration when the brightness lies below the set threshold.

#### **11.1.9 Setting the brightness-value threshold via**

If you select "Potentiometer on the device" it is no longer possible to change the value via the bus.

#### **11.1.10 Setting the switch-off delay via**

If you select "Potentiometer on the device" it is no longer possible to change the value via the bus.

#### **11.1.11 Overwrite settings during download**

The following parameters will be overwritten:

- switch-off delay
- internal and external brightness-value threshold of the movement detector

If the user has made changes on the device, it can be specified whether these changes should be overwritten when the device is reprogrammed.

#### **11.1.12 Sensitivity of the watchdog**

Low:

Intended for use outdoors when interfering heat sources are located within the detection range of the watchdog.

Medium:

Intended for use outdoors (without interfering heat sources within the detection range).

High:

Intended for indoor use.

Note:

The transmission range can NOT be changed via the sensitivity.

#### **11.1.13 Enable with**

The unit is normally enabled with the receipt of an ON telegram on the object and blocked with an OFF telegram. This parameter can invert this behaviour.

#### **11.1.14 Brightness threshold internal (lux)**

Brightness-value threshold for the light sensor of the movement detector.

The detection of movement is active only when falling below this threshold, i.e. only in this case is the "Value for switch-on" sent via the "Movement output".

#### **11.1.15 Detection independent of brightness after return of bus voltage**

deactivated = brightness-dependent

#### 11.1.16 Switch-off delay

Input format: hh:mm:ss

The times that can be entered are between 10 seconds and 18 hours, 12 minutes and 15 seconds (18:12:15).

#### 11.1.17 External push-button object

Via object "External push-button input" it is possible to manually change the (output) status of the movement detector with the aid of a 1-bit telegram. It is used especially in the "Automatic switch-on" mode for switching off and in "Automatic switch-off" mode for switching on.

#### 11.1.18 Object for switch-off delay

Values between 10 and 65,535 seconds (approximately 18 hours) can be set via this 2-byte "switch-off delay" unsigned communication object.

The value received is stored in the memory of the device and is also retained after the return of bus voltage.

#### 11.1.19 Object for external brightness threshold

This parameter is used to activate the input for setting the "External brightness-value threshold" (2-byte float). The value received is the external brightness-value threshold beginning from which the movement detector switches brightness-dependent. I. e., if a value is received on the external brightness object that is smaller than the value received last on the "External brightness-value threshold" object, the movement detector sends a telegram via the "Movement output" object to the bus when it detects movement.

#### 11.1.20 Object for detection independent of brightness

This parameter can be used to enable the input "Detection independent of brightness".

#### 11.1.21 Object for internal brightness threshold

This parameter is used to activate the input for setting the "Internal brightness-value threshold" (2-byte float). The value received is the brightness-value threshold beginning from which the movement detector switches brightness-dependent. I. e., if a value is determined with the internal brightness sensor that is smaller than the value received last on the "Internal brightness-value threshold" object, the movement detector sends a telegram via the "Movement output" object to the bus when it detects movement.

#### 11.1.22 Manual mode object

If an ON telegram is received on this input, the movement detector is deactivated. In this case only manual operation is possible via the "External push-button input". The receipt of an OFF telegram resets the movement detector to the movement detector mode.

#### 11.1.23 Activating sensors

The detection zone of the movement detector is covered by two sensors that can be deactivated individually. Note: The direction of detection starts "From the view of the movement detector".

#### 11.1.24 Status LED

This parameter is used to activate the output (1 bit) for the control of a status LED.

An activated LED means that the movement detector is deactivated and only one manual operation is possible via the external push-button input. Conversely, the movement detector is activated.

#### 11.1.25 Pause time (ms)

In certain situations it would be practical to deactivate the detection of movement for a short period (pause time) after the switch-off, to prevent an unwanted, renewed switch-on.

#### 11.1.26 Value for switching off

Defines the value that is sent out during the switch-off.

1 byte (0 - 100%) in steps of 1%

1 byte (0 - 255) in steps of 1

Light scene number (1 - 64)

#### 11.1.27 Value for switching on

Defines the value that is sent out during the switch-on.

1 byte (0 - 100%) in steps of 1%

1 byte (0 - 255) in steps of 1

Light scene number (1 - 64)

#### 11.1.28 Cyclical repeat time (s)

Input format: hh:mm:ss

The times that can be entered are between 10 seconds and 18 hours, 12 minutes and 15 seconds (18:12:15).

**11.2 Objects**  
**Object "Motion detector"**

No.	Object name	Data type	Flags
0	Enable movement	1 bit EIS 1 / DPT 1.001	C, W, U
1	Input switch-OFF delay	2 byte EIS 5 / DPT 7.005	C, W, U
2	Input Slave	1 bit EIS 1 / DTP 1.001	C, W, U
3	Input actuator status	1 bit EIS 1 / DTP 1.001	C, W, U
4	Input independent detection of brightness	1 bit EIS 1 / DTP 1.001	C, W, U
5	Input external brightness	2 byte EIS 5 /DPT 9.004	C, W, U
6	Input brightness threshold external	2 byte EIS 5 /DPT 9.004	C, W, U
7	Input brightness threshold internal	2 byte EIS 5 /DPT 9.004	C, W, U
8	Output status LED	1 bit EIS 1 / DTP 1.001	C, T
9	Output movement (Master)	1 bit EIS 1 / DTP 1.001	C, T
10	Output movement (Slave)	1 bit EIS 1 / DTP 1.001	C, W, T
11	Input switchover manual operation	1 bit EIS 1 / DTP 1.001	C, W, U
12	Input external button	1 bit EIS 1 / DTP 1.001	C, W, U

## 12 "Twilight switch" application

### 12.1 Parameters

#### 12.1.1 Cool-down time of the lamp

Some lamps require a certain time to return to total darkness (e.g. energy-saving lamps). This time must be known to the twilight switch for a precise calculation of the artificial light component.

#### 12.1.2 Number of actuator status inputs

Up to eight actuator status inputs ( 1 bit) can be activated via this parameter. To determine the brightness content of the artificial light from the total brightness, all switching processes from lighting in the detection range of the detector must be signaled to the twilight switch (only one group address per input).

Note: Also the status of the actuator activated by the movement detector must be connected.

#### 12.1.3 Number of twilight thresholds

The twilight switch has up to three independent twilight thresholds with separate outputs.

#### 12.1.4 Warm-up time of the lamp

Some lamps require a certain time to reach maximum brightness (e.g. energy-saving lamps). This time must be known to the twilight switch for a precise calculation of the artificial light component.

#### 12.1.5 Output brightness/twilight switch sends at

Shortfall = ambient brightness < brightness/twilight threshold - hysteresis

Exceeding = ambient brightness > brightness/twilight threshold - hysteresis

#### 12.1.6 Twilight threshold (lux)

Switching threshold = twilight threshold ± hysteresis

The twilight threshold defines the lower and upper switching threshold in connection with the hysteresis.

#### 12.1.7 Overwrite settings during download

The following parameters will be overwritten:

- Twilight thresholds
- rejecting the calculated artificial light values

If the user has made changes on the device, it can be specified whether these changes should be overwritten when the device is reprogrammed.

#### 12.1.8 Enable object brightness/twilight switch

This switching threshold can be activated / deactivated with the enable object.

#### 12.1.9 Brightness detection

To determine the ambient brightness either the total brightness measured by the device (internal) or the value received via the "External brightness" object can be used.

#### 12.1.10 Hysteresis

Switching threshold = twilight threshold ± hysteresis

The hysteresis prevents excessive switching when the current ambient brightness is close to the twilight threshold.

#### 12.1.11 Lamps in the detection range

No:

No determination of the artificial light component (ambient brightness = total brightness)

Yes:

Artificial light component is calculated (Ambient brightness = total brightness - brightness of artificial light)

The calculation of artificial light is only required and practical when light sources that have been switched via the bus and / or the watchdog lie within the detection range of the watchdog.

#### 12.1.12 Minimum duration of undershoot

A telegram will only be sent when the set time for the switching threshold has fallen short. This prevents false triggering due to short-term changes in brightness.

#### 12.1.13 Minimum duration of overshoot

A telegram will only be sent when the set time for the switching threshold has been exceeded. This prevents false triggering due to short-term changes in brightness.

#### 12.1.14 Object output ambient brightness (lux)

Ambient brightness = total brightness - brightness of artificial light

To determine the brightness of the artificial light the twilight switch has several actuator inputs. Each time the status changes, the resulting change in brightness is measured and the content of the artificial light recalculated.

#### 12.1.15 Object input brightness/twilight threshold

Adjusting range: 1 to 1000 lux

With this 2-byte float object the twilight threshold can be adjusted via the bus.

#### 12.1.16 Threshold programmable via the bus (1 bit)

If an On telegram is received on this object, the currently measured ambient brightness value is taken over as twilight threshold.

## 12.2 Objects

### "Twilight switch" objects

No.	Object name	Data type	Flags
0	Natural ambient brightness	2 byte EIS 5 /DPT 9.004	C, R, T
1	External brightness	2 byte EIS 5 /DPT 9.004	C, R, W, T, U
2	Enable DS1	1 bit EIS 1 / DTP 1.001	C, W, U
3	Enable DS2	1 bit EIS 1 / DTP 1.001	C, W, U
4	Enable DS3	1 bit EIS 1 / DTP 1.001	C, W, U
5	Twilight switch 1	1 bit EIS 1 / DTP 1.001	C, R, T
6	Twilight switch 2	1 bit EIS 1 / DTP 1.001	C, R, T
7	Twilight switch 3	1 bit EIS 1 / DTP 1.001	C, R, T
8	Twilight threshold 1	2 byte EIS 5 /DPT 9.004	C, R, W, T, U
9	Twilight threshold 2	2 byte EIS 5 /DPT 9.004	C, R, W, T, U
10	Twilight threshold 3	2 byte EIS 5 /DPT 9.004	C, R, W, T, U
11	Input twilight threshold 1 learn	1 bit EIS 1 / DTP 1.001	C, W
12	Input twilight threshold 2 learn	1 bit EIS 1 / DTP 1.001	C, W
13	Input twilight threshold 3 learn	1 bit EIS 1 / DTP 1.001	C, W
14	Actuator status 1	1 bit EIS 1 / DTP 1.001	C, W, U
15	Actuator status 2	1 bit EIS 1 / DTP 1.001	C, W, U
16	Actuator status 3	1 bit EIS 1 / DTP 1.001	C, W, U
17	Actuator status 4	1 bit EIS 1 / DTP 1.001	C, W, U
18	Actuator status 5	1 bit EIS 1 / DTP 1.001	C, W, U
19	Actuator status 6	1 bit EIS 1 / DTP 1.001	C, W, U
20	Actuator status 7	1 bit EIS 1 / DTP 1.001	C, W, U
21	Actuator status 8	1 bit EIS 1 / DTP 1.001	C, W, U



## 13 "Brightness switch" application

### 13.1 Parameters

#### 13.1.1 Cool-down time of the lamp

Some lamps require a certain time to return to total darkness (e.g. energy-saving lamps). This time must be known to the brightness/twilight switch for a precise calculation of the artificial light component.

#### 13.1.2 Number of actuator status inputs

Up to eight actuator status inputs ( 1 bit) can be activated via this parameter. To determine the brightness content of the artificial light from the total brightness, all switching processes from lighting in the detection range of the detector must be signaled separately to the brightness/twilight switch (only one group address per input).

Note: Also the status of the actuator activated by the movement detector must be connected.

#### 13.1.3 Number of brightness/twilight thresholds

The brightness/twilight switch has up to three independent brightness/twilight thresholds with separate outputs.

#### 13.1.4 Warm-up time of the lamp

Some lamps require a certain time to reach maximum brightness (e.g. energy-saving lamps). This time must be known to the brightness/twilight switch for a precise calculation of the artificial light component.

#### 13.1.5 Output brightness/twilight switch sends at

Shortfall = ambient brightness < brightness/twilight threshold - hysteresis

Exceeding = ambient brightness > brightness/twilight threshold + hysteresis + hysteresis

#### 13.1.6 Overwrite settings during download

The following parameters will be overwritten:

- brightness/twilight thresholds
- rejecting the calculated artificial light values

If the user has made changes on the device, it can be specified whether these changes should be overwritten when the device is reprogrammed.

#### 13.1.7 Enable object brightness/twilight switch

This switching threshold can be activated / deactivated with the enable object.

#### 13.1.8 Brightness/twilight threshold (lux)

Switching threshold = brightness/twilight threshold ± hysteresis

The brightness/twilight threshold defines the lower and upper switching threshold in connection with the hysteresis.

#### 13.1.9 Brightness detection

To determine the ambient brightness either the total brightness measured by the device (internal) or the value received via the "External brightness" object can be used.

#### 13.1.10 Hysteresis

Switching threshold = brightness/twilight threshold ± hysteresis

The hysteresis prevents excessive switching when the current ambient brightness is close to the brightness threshold.

#### 13.1.11 Lamps in the detection range

No:

No determination of the artificial light component (ambient brightness = total brightness)

Yes:

Artificial light component is calculated (Ambient brightness = total brightness - brightness of artificial light)

The calculation of artificial light is only required and practical when light sources that have been switched via the bus and / or the watchdog lie within the detection range of the watchdog.

#### 13.1.12 Minimum duration of overshoot

A telegram will only be sent when the set time for the switching threshold has been exceeded. This prevents false triggering due to short-term changes in brightness.

#### 13.1.13 Minimum duration of undershoot

A telegram will only be sent when the set time for the switching threshold has fallen short. This prevents false triggering due to short-term changes in brightness.

#### 13.1.14 Object output ambient brightness (lux)

Ambient brightness = total brightness - brightness of artificial light

To determine the brightness of the artificial light the brightness/twilight switch has several actuator inputs. Each time the status changes, the resulting change in brightness is measured and the content of the artificial light recalculated.

#### 13.1.15 Object input brightness/twilight threshold

Adjusting range for twilight switch: 1 - 1000 lux

Adjusting range for brightness switch: 1000 - 80,000 lux

With this 2-byte float object the brightness/twilight threshold can be adjusted via the bus.

#### 13.1.16 Threshold programmable via the bus (1 bit)

If an On telegram is received on this object, the currently measured ambient brightness value is taken over as brightness/twilight threshold.

## 13.2 Objects

### "Brightness switch" objects

No.	Object name	Data type	Flags
0	Output natural ambient brightness	2 byte EIS 5 / DPT 9.004	C, R, T
1	Input External brightness	2 byte EIS 5 / DPT 9.004	C, R, W, T, U
2	Enable brightness/twilight threshold 1	1 bit EIS 1 / DPT 1.001	C, W, U
3	Enable brightness/twilight threshold 2	1 bit EIS 1 / DPT 1.001	C, W, U
4	Enable brightness/twilight threshold 3	1 bit EIS 1 / DPT 1.001	C, W, U
5	Output brightness/twilight threshold 1	1 bit EIS 1 / DPT 1.001	C, R, T
6	Output brightness/twilight threshold 2	1 bit EIS 1 / DPT 1.001	C, R, T
7	Output brightness/twilight threshold 3	1 bit EIS 1 / DPT 1.001	C, R, T
8	Input brightness/twilight threshold 1	2 byte EIS 5 / DPT 9.004	C, R, W, T, U
9	Input brightness/twilight threshold 2	2 byte EIS 5 / DPT 9.004	C, R, W, T, U
10	Input brightness/twilight threshold 3	2 byte EIS 5 / DPT 9.004	C, R, W, T, U
11	Input brightness/twilight threshold 1 learn	1 bit EIS 1 / DPT 1.001	C, W
12	Input brightness/twilight threshold 2 learn	1 bit EIS 1 / DPT 1.001	C, W
13	Input brightness/twilight threshold 3 learn	1 bit EIS 1 / DPT 1.001	C, W
14	Actuator status 1	1 bit EIS 1 / DPT 1.001	C, W, U
15	Actuator status 2	1 bit EIS 1 / DPT 1.001	C, W, U
16	Actuator status 3	1 bit EIS 1 / DPT 1.001	C, W, U
17	Actuator status 4	1 bit EIS 1 / DPT 1.001	C, W, U
18	Actuator status 5	1 bit EIS 1 / DPT 1.001	C, W, U
19	Actuator status 6	1 bit EIS 1 / DPT 1.001	C, W, U
20	Actuator status 7	1 bit EIS 1 / DPT 1.001	C, W, U
21	Actuator status 8	1 bit EIS 1 / DPT 1.001	C, W, U
22	Input reset artificial light calculation	1 bit EIS 1 / DPT 1.001	C, W, U
23	Output total brightness	2 byte EIS 5 / DPT 9.004	C, R, T

## 14 "Temperature switch" application

### 14.1 Parameters

#### 14.1.1 Number of temperature thresholds

The temperature switch has up to three independent temperature thresholds with separate outputs.

#### 14.1.2 Output temperature switch sends at

Undershoot = temperature < temperature threshold - hysteresis

Exceeding = temperature > temperature threshold + hysteresis

#### 14.1.3 Overwrite settings during download

The following parameters will be overwritten:

- temperature thresholds

If the user has made changes on the device, it can be specified whether these changes should be overwritten when the device is reprogrammed.

#### 14.1.4 Enable object temperature switch

This switching threshold can be activated / deactivated with the enable object.

#### 14.1.5 Hysteresis

Switching threshold = temperature threshold ± hysteresis

The hysteresis prevents excessive switching when the current ambient temperature is close to the temperature threshold.

#### 14.1.6 Minimum duration of overshoot

A telegram will only be sent when the set time for the switching threshold has been exceeded. This prevents false triggering due to short-term changes in temperature.

#### 14.1.7 Minimum duration of undershoot

A telegram will only be sent when the set time for the switching threshold has fallen short. This prevents false triggering due to short-term changes in temperature.

#### 14.1.8 Object input temperature threshold

Adjusting range: -25°C ... 55°C

With this 2-byte object the temperature threshold can be adjusted via the bus.

#### 14.1.9 Threshold programmable via the bus (1 bit)

If an On telegram is received on this object, the currently measured temperature is taken over as temperature threshold.

#### 14.1.10 Temperature reading

Either the internally determined value or the external value received via the corresponding object can be used as temperature.

#### 14.1.11 Temperature threshold °C

Switching threshold = temperature threshold ± hysteresis

The temperature threshold defines the lower and upper switching threshold in connection with the hysteresis.

## 14.2 Objects

### "Temperature switch" object

No.	Object name	Data type	Flags
0	Output temperature	2 byte EIS 5 / DPT 9.004	C, R, T
1	Input External temperature	2 byte EIS 5 / DPT 9.004	C, R, W, T, U
2	Enable temperature threshold 1	1 bit EIS 1 / DPT 1.001	C, W, U
3	Enable temperature threshold 2	1 bit EIS 1 / DPT 1.001	C, W, U
4	Enable temperature threshold 3	1 bit EIS 1 / DPT 1.001	C, W, U
5	Output temperature threshold 1	1 bit EIS 1 / DPT 1.001	C, R, T
6	Output temperature threshold 2	1 bit EIS 1 / DPT 1.001	C, R, T
7	Output temperature threshold 3	1 bit EIS 1 / DPT 1.001	C, R, T
8	Input temperature threshold 1	2 byte EIS 5 / DPT 9.001	C, R, W, T, U
9	Input temperature threshold 2	2 byte EIS 5 / DPT 9.001	C, R, W, T, U
10	Input temperature threshold 3	2 byte EIS 5 / DPT 9.001	C, R, W, T, U
11	Input temperature threshold 1 learn	1 bit EIS 1 / DPT 1.001	C, W
12	Input temperature threshold 2 learn	1 bit EIS 1 / DPT 1.001	C, W
13	Input temperature threshold 3 learn	1 bit EIS 1 / DPT 1.001	C, W

A member of the ABB Group

**Busch-Jaeger Elektro GmbH**

PO box  
58505 Lüdenscheid

Freisenbergstraße 2  
58513 Lüdenscheid  
Germany

**www.BUSCH-JAEGER.com**

info.bje@de.abb.com

**Central sales service:**

Phone: +49 (0) 2351 956-1600

Fax: +49 (0) 2351 956-1700

**Notice**

We reserve the right to at all times make technical changes as well as changes to the contents of this document without prior notice.

The detailed specifications agreed to at the time of ordering apply to all orders. ABB accepts no responsibility for possible errors or incompleteness in this document.

We reserve all rights to this document and the topics and illustrations contained therein. The document and its contents, or extracts thereof, must not be reproduced, transmitted or reused by third parties without prior written consent by ABB.

Copyright© 2012 Busch-Jaeger Elektro GmbH  
All rights reserved